

ALLEN & HEATH



Xone:10

USER GUIDE

Publication AP7080

Limited One Year Warranty

This product is warranted to be free from defects in materials or workmanship for period of one year from the date of purchase by the original owner.

To ensure a high level of performance and reliability for which this equipment has been designed and manufactured, read this User Guide before operating. In the event of a failure, notify and return the defective unit to ALLEN & HEATH Limited or its authorised agent as soon as possible for repair under warranty subject to the following conditions

Conditions Of Warranty

The equipment has been installed and operated in accordance with the instructions in this User Guide.

The equipment has not been subject to misuse either intended or accidental, neglect, or alteration other than as described in the User Guide or Service Manual, or approved by ALLEN & HEATH.

Any necessary adjustment, alteration or repair has been carried out by ALLEN & HEATH or its authorised agent.

This warranty does not cover fader wear and tear.

The defective unit is to be returned carriage prepaid to ALLEN & HEATH or its authorised agent with proof of purchase.

Units returned should be packed to avoid transit damage.

In certain territories the terms may vary. Check with your ALLEN & HEATH agent for any additional warranty which may apply.

 This product complies with the European Electro magnetic Compatibility directives 89/336/EEC & 92/31/EEC and the European Low Voltage Directives 73/23/EEC & 93/68/EEC.

This product has been tested to EN55103 Parts 1 & 2 1996 for use in Environments E1, E2, E3, and E4 to demonstrate compliance with the protection requirements in the European EMC directive 89/336/EEC. During some tests the specified performance figures of the product were affected. This is considered permissible and the product has been passed as acceptable for its intended use. Allen & Heath has a strict policy of ensuring all products are tested to the latest safety and EMC standards. Customers requiring more information about EMC and safety issues can contact Allen & Heath.

XONE:ID User Guide AP7080 Issue 3

Copyright © 2007 Allen & Heath Limited. All rights reserved

Allen & Heath Limited

Kernick Industrial Estate, Penryn, Cornwall, TR10 9LU, UK

<http://www.allen-heath.com> <http://www.xone.co.uk>

PACKED ITEMS

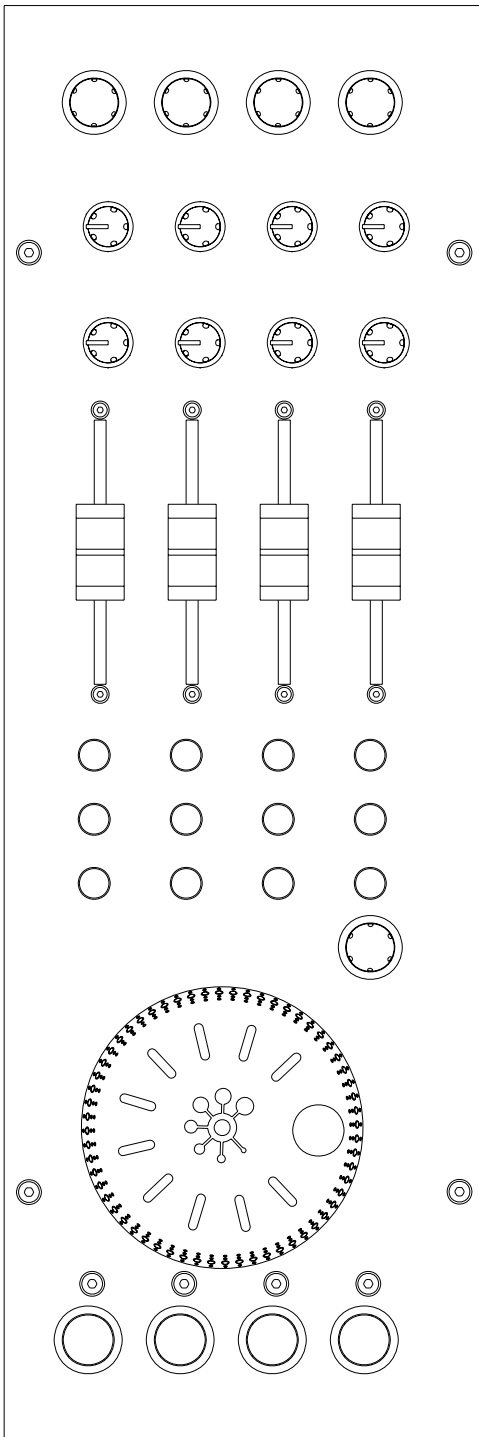

Xone:ID MIDI Controller

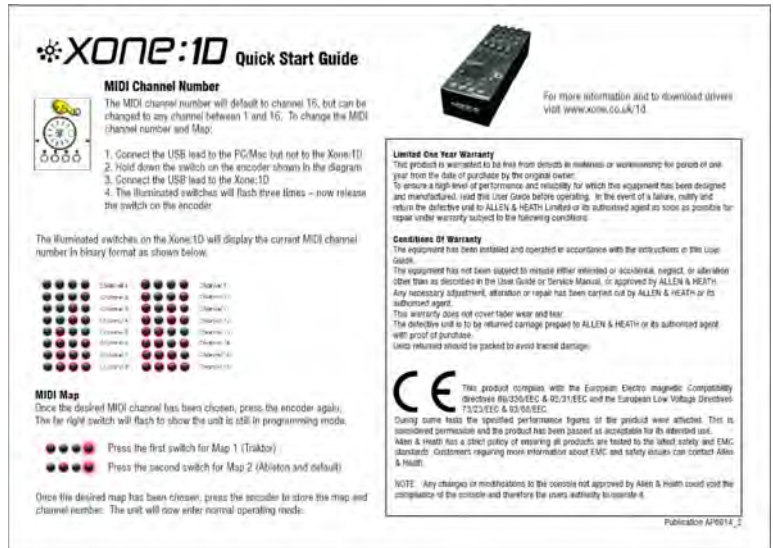

Xone:ID Quick-Start Guide and Warranty.

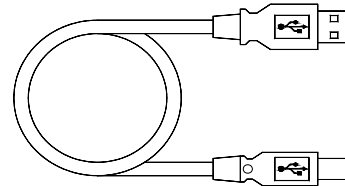

Type A-B USB Lead
To connect the Xone:ID to your computer.

CONTENTS

Congratulations on purchasing the Allen & Heath Xone:ID MIDI Controller. To ensure that you get the maximum benefit from the unit please spare a few minutes familiarizing yourself with the controls and setup procedures outlined in this user guide. For further information please refer to the additional information available on our web site, or contact our technical support team.

<http://www.xone.co.uk>

<http://www.allen-heath.com>

Warranty.....	2
Packed Items.....	3
MIDI Controls.....	5
MIDI Control Section.....	6
Rear Panel Connectors.....	7
Windows Driver Installation.....	8
Windows DAW Setup.....	10
Mac Installation.....	11
Mac DAW Setup.....	12
MIDI Channel Number.....	13
MIDI Map and Light Pipe Set Up	14

MIDI CONTROLS

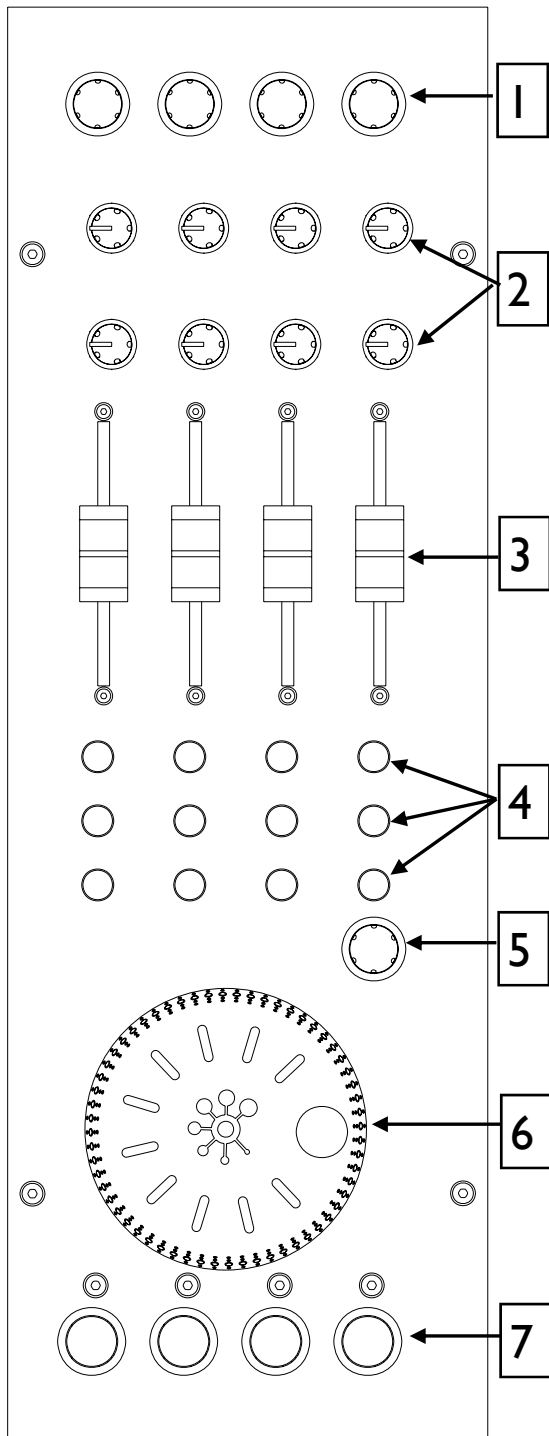

1 Rotary Encoders

Turning an encoder produces MIDI CC (continuous controller) messages with a unique controller number in two's complement binary encoding (Map2) or Note on messages (Map1) - see diagram overleaf.

These encoders feature a built in momentary push switch. Pressing down on the encoder knob activates the switch and sends a "note on" MIDI message, releasing the switch sends a corresponding "note off" message.

2 Rotary Potentiometers

These controls are standard potentiometers with end stops and a centre detent for easy setting. Turning a pot from left to right will send MIDI messages with a unique CC number and a control value from 0 to 127.

3 Linear Faders

Moving a linear fader will send a MIDI message with a unique CC number and a control value from 0 (bottom) to 127 (top).

4 Push Buttons

There are 12 momentary action switches coded with letters M through to X for easy identification. Pressing a switch will send a unique "note on" MIDI message. Releasing the switch sends a corresponding "note off" message.

5 Rotary Encoder

A rotary encoder with switch, as above.

6 Jog Wheel

The jog wheel features an optical encoder, which produces CC messages in a similar way to the other encoders. Switches are located at the top, bottom, left and right of the wheel. Pushing down on the face of the wheel sends note on / note off messages.

7 Illuminated Push Buttons

Momentary action switches with red light ring indicators. Pressing a switch will send a "note on" MIDI message, releasing the switch will send a "note off" message.

If the MIDI Map is set to Map 1, the illuminated rings will stay on permanently. If the MIDI Map is set to Map 2 they will toggle each time the switch is pressed.

MIDI CONTROL SECTION

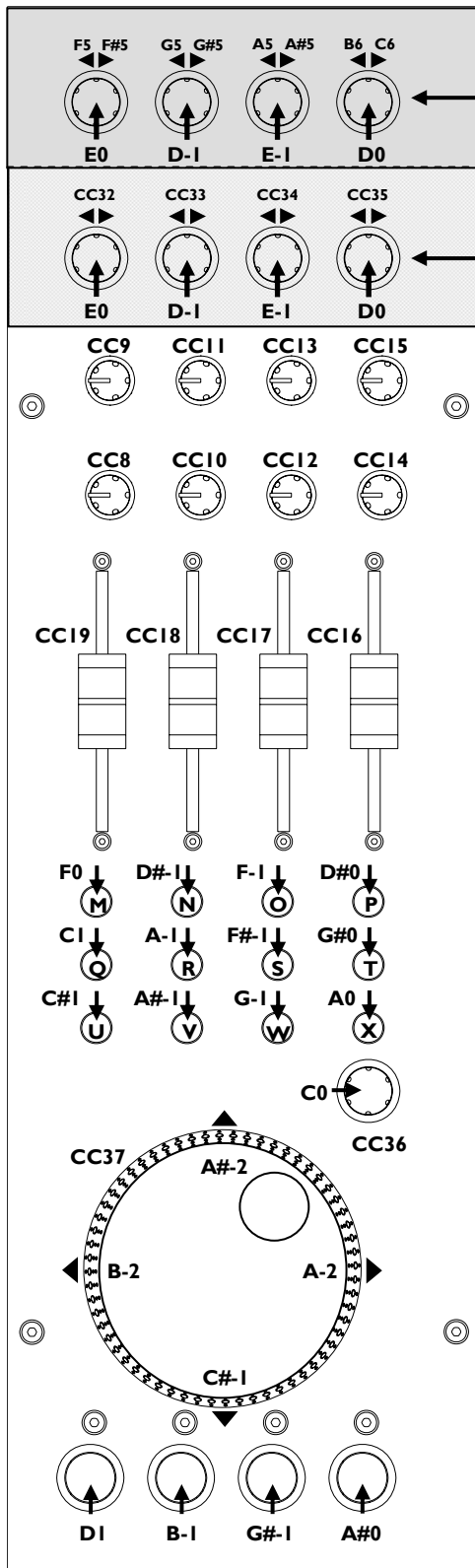

MAP 1

MAP 2

MIDI Map

Two control mappings are available, Map2 is the default for most applications. Map1 differs only in the messages generated by the top row of rotary encoders and the four illuminated switches. Use Map2 with Ableton Live software. Map1 is recommended for use with Native Instruments Traktor software.

MIDI Messages

The diagram shows which controls are associated with MIDI CC (continuous controller) and note on/off messages. These controls send the MIDI messages shown when operated.

The rotary encoders and jog wheel are digital controls that send 2's complement data rather than absolute values. For a more in depth description of how to set up the MIDI controls please refer to the Technical Tutorials on the Xone website:

www.xone.co.uk

The switch light ring indicators may be turned on or off by incoming MIDI messages.

REAR PANEL CONNECTORS

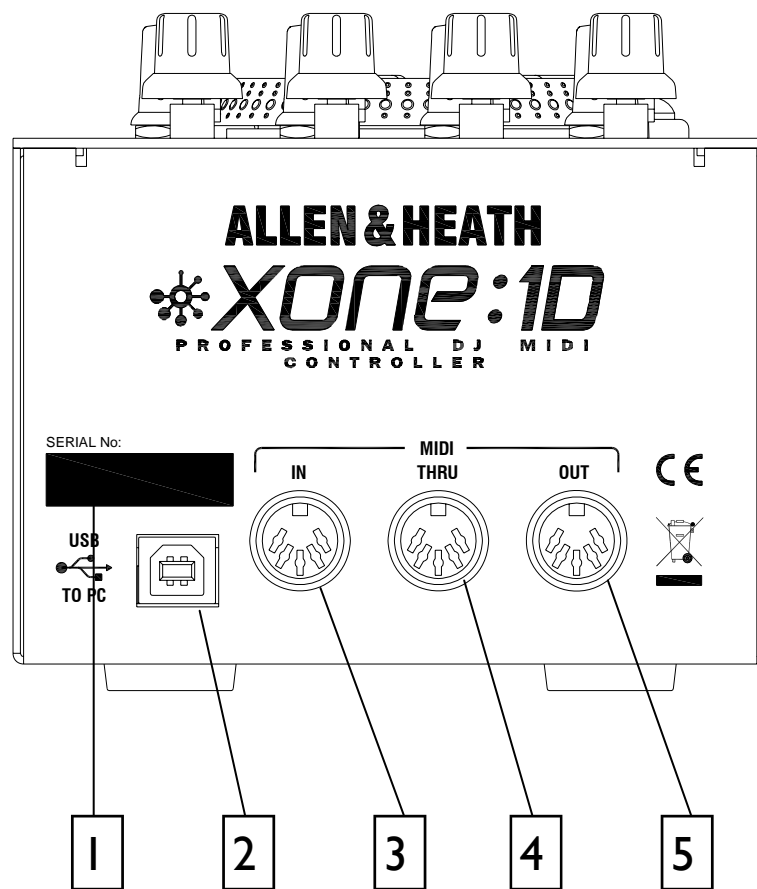

1 SERIAL NUMBER
The serial number of your Xone:1D

2 USB Connector
Socket for connecting the Xone:1D to the PC/Mac

3 MIDI In Socket
5-pin DIN style socket for connecting other MIDI devices through the Xone:1D. The messages from the other device(s) are merged with the MIDI from the Xone:1D controls before being sent to the PC via USB.

4 MIDI THRU Socket
5-pin DIN style socket for daisy-chaining to other MIDI devices. The MIDI THRU socket outputs what is coming into the MIDI IN socket.

5 MIDI OUT Socket
5-pin DIN style socket for connecting to other MIDI devices. The data on the MIDI OUT socket is the Xone:1D data merged with the USB data.

WINDOWS DRIVER INSTALLATION

The Allen & Heath Xone:ID is fully compliant with Windows XP and will plug and play. The Xone:ID will be recognised as a USB Audio Device in XP and will be labelled as such in System Manager and in the setup of any DAW software. Installation of the drivers will label the Xone:ID as a “Xone MIDI Device” both in System Manager and in the setup of any Digital Audio Workstation software.

The drivers must be installed for the Xone:ID to function if using Windows 2000 or Vista.

To download the drivers for the Xone:ID visit:

www.xone.co.uk and follow the links for the Xone:ID.



To start the driver installation, make sure that the Xone:ID is NOT connected to your PC and click on Setup.exe in the driver folder.

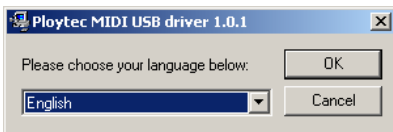

Choose your desired language from the drop down menu.

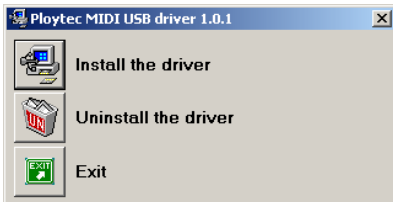

Once your language has been selected click on “Install the Driver”.

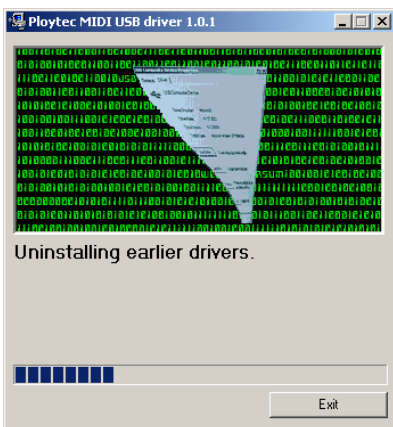

The installation will first uninstall any earlier drivers.

WINDOWS DRIVER INSTALLATION



Now plug the Xone:ID to a USB port on your PC.

NOTE: The drivers will map to the USB socket used in the installation. To ensure that your Xone:ID works on all USB ports repeat the driver installation for each port.



Once the Xone:ID has been plugged in the installation will initialise it.



Next the USB drivers will be installed.

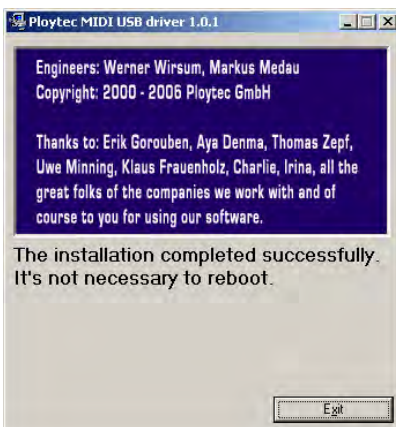

This window indicates the installation is complete.

WINDOWS SOFTWARE SETUP

Setting up the Xone:ID with Ableton

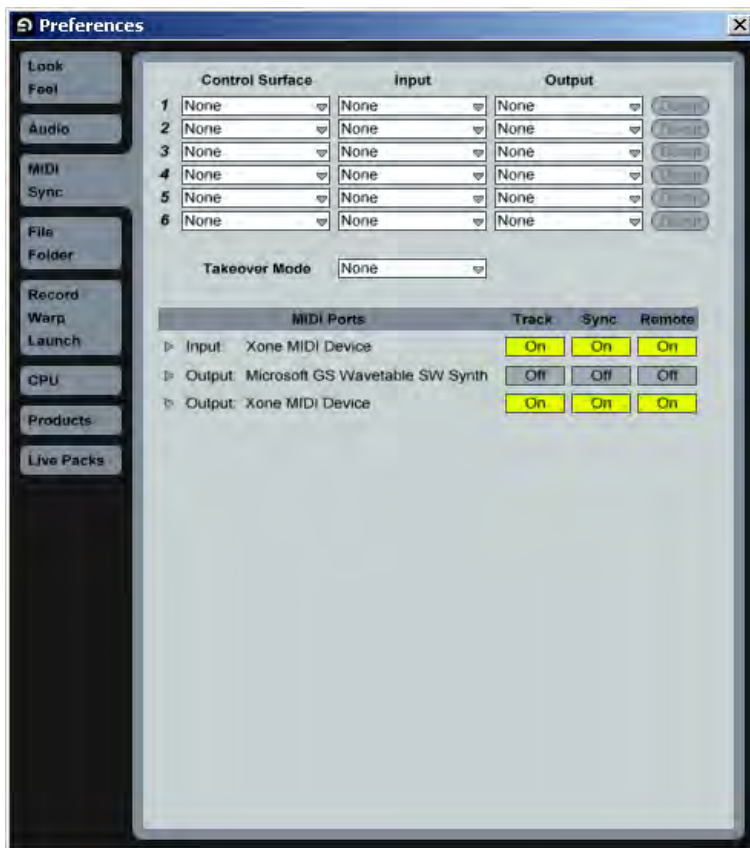

In the Preferences window of Ableton select the MIDI / Sync tab. Turn on the Track, Sync and Remote for both the Input and Output of the Xone MIDI Device.

Setting up the Xone:ID with Traktor3



In the Preferences window of Traktor select Hotkey and MIDI Setup then MIDI interfaces. Make sure there is an X in the active box next to Allen and Heath Xone MIDI Device.

MAC INSTALLATION

Plug the Xone:ID into a USB port on your Mac and follow:

Macintosh HD -> Applications -> Utilities -> Audio MIDI Setup -> MIDI Devices



The Xone:ID is shown as a Xone MIDI Device as above.

MAC SOFTWARE SETUP

Setting up the Xone:ID with Ableton



In the Preferences window of Ableton select the MIDI / Sync tab. Turn on the Track, Sync and Remote for both the Input and Output of the Xone MIDI Device.

Setting up the Xone:ID with Traktor3



In the Preferences window of Traktor select Hotkey and MIDI Setup then MIDI interfaces. Make sure there is an X in the active box next to Allen and Heath Xone MIDI Device.

MIDI CHANNEL NUMBER

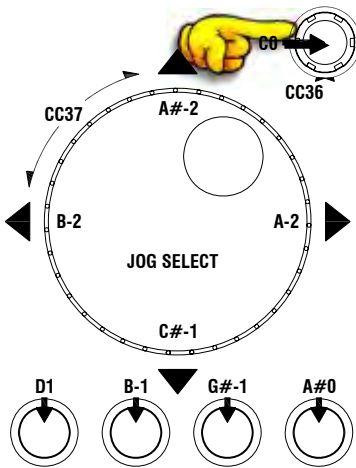

MIDI Channel Number

The MIDI channel number will default to channel 16, but can be changed to any channel between 1 and 16.

To change the MIDI channel number and MIDI map:

1. Connect the USB cable to the PC/Mac but not the Xone:ID
2. Hold down the switch on the encoder shown in the diagram
3. Connect the USB cable to the Xone:ID
4. The illuminated switches will flash three times—now release the switch on the encoder

The illuminated switches on the Xone:ID will display the current MIDI channel number in binary format as shown below.

<input type="checkbox"/> <input type="checkbox"/> <input type="checkbox"/> <input type="checkbox"/>	Channel 1	<input checked="" type="checkbox"/> <input type="checkbox"/> <input type="checkbox"/> <input type="checkbox"/>	Channel 9
<input type="checkbox"/> <input type="checkbox"/> <input type="checkbox"/> <input checked="" type="checkbox"/>	Channel 2	<input checked="" type="checkbox"/> <input type="checkbox"/> <input type="checkbox"/> <input checked="" type="checkbox"/>	Channel 10
<input type="checkbox"/> <input type="checkbox"/> <input checked="" type="checkbox"/> <input type="checkbox"/>	Channel 3	<input checked="" type="checkbox"/> <input type="checkbox"/> <input checked="" type="checkbox"/> <input type="checkbox"/>	Channel 11
<input type="checkbox"/> <input type="checkbox"/> <input checked="" type="checkbox"/> <input checked="" type="checkbox"/>	Channel 4	<input checked="" type="checkbox"/> <input type="checkbox"/> <input checked="" type="checkbox"/> <input checked="" type="checkbox"/>	Channel 12
<input type="checkbox"/> <input checked="" type="checkbox"/> <input type="checkbox"/> <input type="checkbox"/>	Channel 5	<input checked="" type="checkbox"/> <input checked="" type="checkbox"/> <input type="checkbox"/> <input type="checkbox"/>	Channel 13
<input type="checkbox"/> <input checked="" type="checkbox"/> <input type="checkbox"/> <input checked="" type="checkbox"/>	Channel 6	<input checked="" type="checkbox"/> <input checked="" type="checkbox"/> <input type="checkbox"/> <input checked="" type="checkbox"/>	Channel 14
<input type="checkbox"/> <input checked="" type="checkbox"/> <input checked="" type="checkbox"/> <input type="checkbox"/>	Channel 7	<input checked="" type="checkbox"/> <input checked="" type="checkbox"/> <input checked="" type="checkbox"/> <input type="checkbox"/>	Channel 15
<input type="checkbox"/> <input checked="" type="checkbox"/> <input checked="" type="checkbox"/> <input checked="" type="checkbox"/>	Channel 8	<input checked="" type="checkbox"/> <input checked="" type="checkbox"/> <input checked="" type="checkbox"/> <input checked="" type="checkbox"/>	Channel 16

To change the channel number that the MIDI is transmitted on, rotate the encoder above the jog wheel.

Once the desired channel has been selected, press and then release the switch on the encoder above the jog wheel, the illuminated switches will flash once indicating that the channel number has been set.

MIDI MAP AND LIGHT PIPE SETUP

Changing the MIDI Map

Once the MIDI channel number has been stored, the illuminated switch to the far right of the unit will flash indicating that the MIDI map may now be selected.

Map 1 (Traktor default)

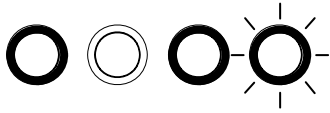

The first switch (far left) is used to select MIDI Map 1. In this map the top row of encoders send 'Note On' messages upon rotation (see **MIDI Control Section p25**).

The third button (centre right) is used to determine the status of the light rings. If the third light ring is illuminated, then during normal operation all four light rings will stay illuminated at all times.

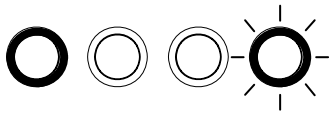

If the third light ring is not illuminated then each light ring will toggle on and off on receipt of a specific MIDI 'Note On' message. The 'Note On' message that the light ring responds to is the same 'Note On' message that is sent by the corresponding switch. Therefore, referencing the **MIDI Control Section**, the first (far left) light pipe will toggle on and off when it receives a 'Note On' message of D1.

Map 2 (Ableton default)



The second switch (centre left) is used to select MIDI Map 2. In this map the top row of encoders send 'Control Change' messages upon rotation (see **MIDI Control Section p25**).

The third button (centre right) is used to determine the status of the light rings. If the third light ring is illuminated, then during normal operation all four light rings will toggle on and off when their respective switch is pressed.

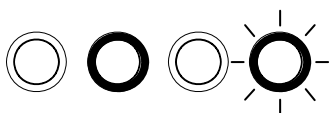

If the third light ring is not illuminated then each light ring will toggle on and off on receipt of a specific MIDI 'Note On' message. The 'Note On' message that the light ring responds to is the same 'Note On' message that is sent by the corresponding switch. Therefore, referencing the **MIDI Control Section**, the second (middle left) light pipe will toggle on and off when it receives a 'Note On' message of B-1.

When the desired MIDI map has been selected, press and release the switch on the encoder above the jog wheel. The illuminated switches will flash three times indicating that the MIDI map has been stored and that the unit is now in its normal operating mode.