

A 0041

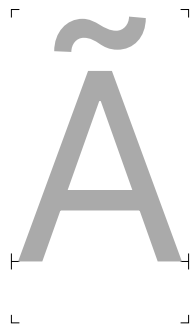

Adieresis 00C4



Atilde 00C3



Agrave 00C0



Aacute 00C1

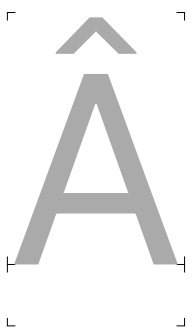

Acircumflex 00C2



Aring 00C5



Amacron 0100



Abreve 0102



Aogonek 0104

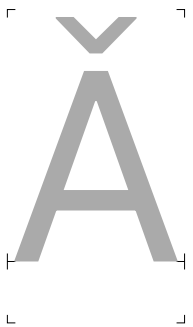

Acaron 01CD



Adieresismacron 01DE



Adotmacron 01E0



Aringacute 01FA



Abllgrave 0200

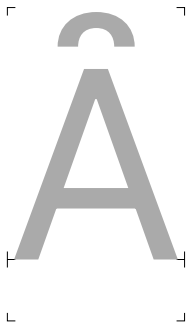

Ainvertedbreve 0202



uni0226 0226

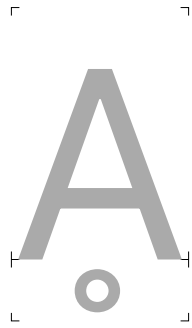

Aringbelow 1E00



Adotbelow 1EA0



Ahookabove 1EA2



Acircumflexacute 1EA4



Acircumflexgrave 1EA6



Acircumflexhookabove 1EA8



Acircumflextilde 1EAA



Acircumflexdotbelow 1EAC



Abreveacute 1EAE

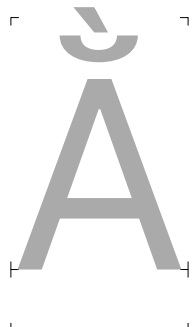

Abrevegrave 1EB0



Abrevehookabove 1EB2



Abrevetilde 1EB4



Abrevedotbelow 1EB6



Alpha 0391



Alphonos 0386



uni1F08 1F08



uni1F09 1F09



uni1F0A 1F0A



uni1F0B

1F0B



uni1F0C

1F0C



uni1F0D

1F0D



uni1F0E

1F0E

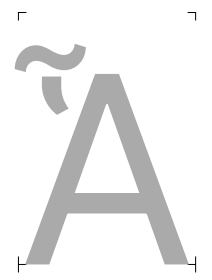

uni1F0F

1F0F

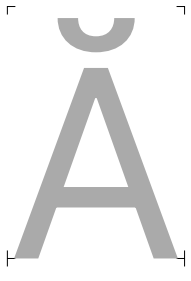

uni1FB8

1FB8



uni1FB9

1FB9



uni1FBA

1FBA

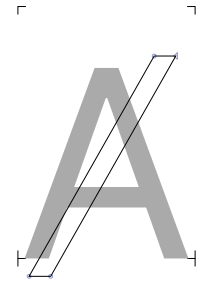

uni023A

023A



uni1FBB

1FBB



afii10017

0410



Abrevescyrllic

04D0



Adieresiscyrllic

04D2



uni1F88

1F88



uni1F89

1F89



uni1F8A

1F8A



uni1F8B

1F8B



uni1F8C

1F8C

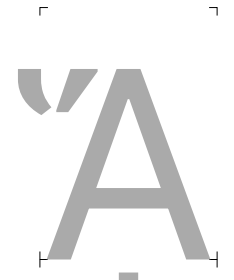

uni1F8D

1F8D



uni1F8E

1F8E



uni1F8F

1F8F



uni1FBC

1FBC

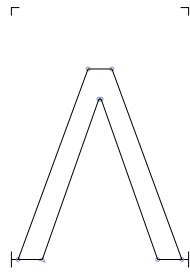

Lambda

039B

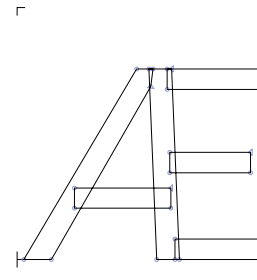

AE

00C6

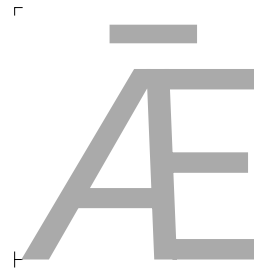

AEmacron

01E2

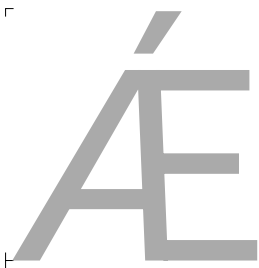

AEacute

01FC



Aiecyrllic

04D4

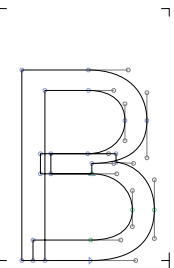

B

0042



Bdotaccent

1E02



Bdotbelow

1E04



Blinebelow

1E06



uni0243

0243

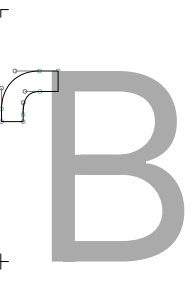

Bhook

0181



afii10019

0412



Beta

0392

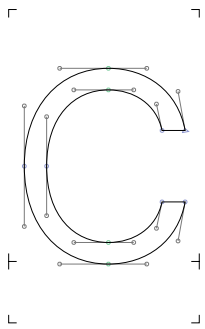

C 0043

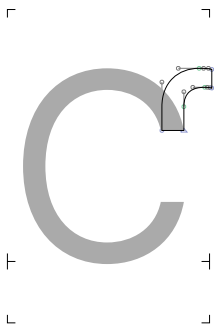

Chook 0187



Ccedilla 00C7

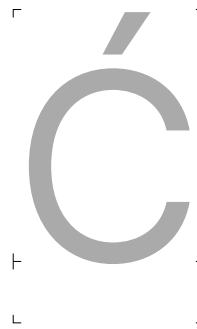

Cacute 0106



Ccircumflex 0108

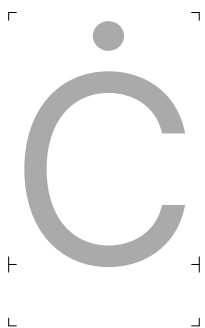

Cdotaccent 010A

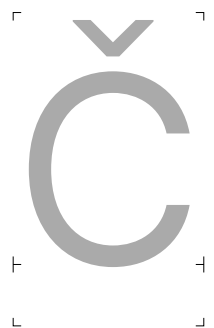

Ccaron 010C



Ccedillaacute 1E08

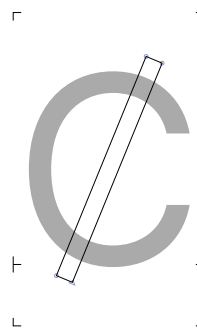

uni023B 023B

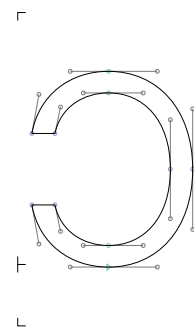

Oopen 0186

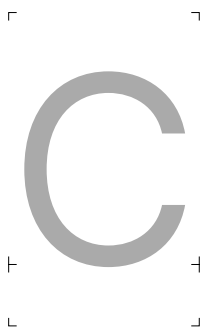

uni03F9 03F9

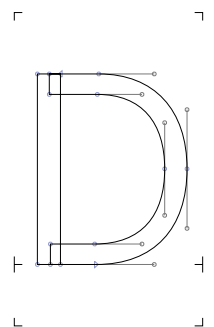

D 0044

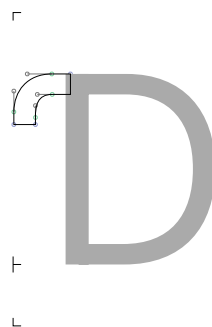

Dhook 018A



Dcaron 010E



Ddotaccent 1E0A

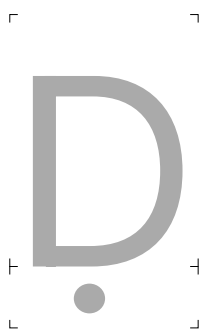

Ddotbelow 1E0C

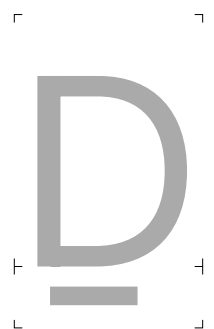

Dlinebelow 1E0E



Dcedilla 1E10



Dcircumflexbelow 1E12



Dbar1 0189



Dz 01F2



Dzcaron_ 01C5

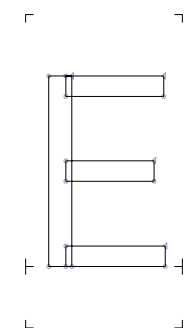

E 0045

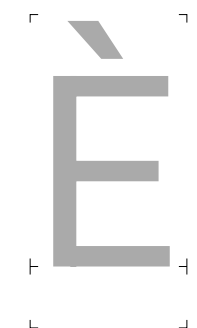

Egrave 00C8



Eacute 00C9

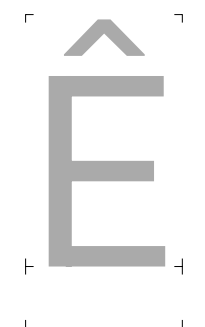

Ecircumflex 00CA

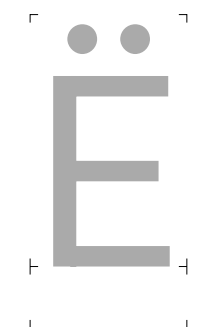

Edieresis 00CB



Emacron 0112

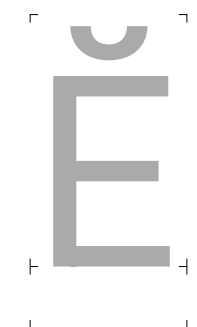

Ebreve 0114



Edotaccent 0116

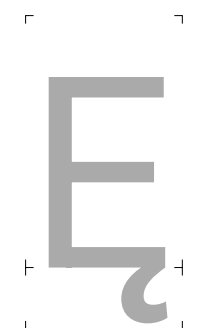

Eogonek 0118

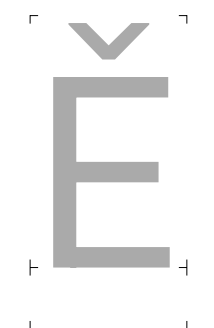

Ecaron 011A



Edblgrave 0204

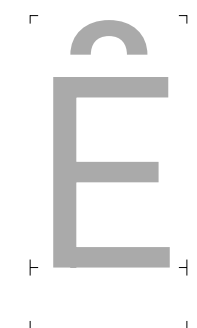

Einvertedbreve 0206



uni0228 0228

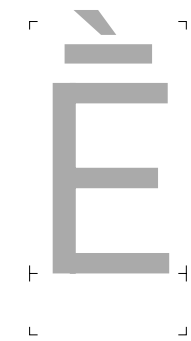

Emacrongrave 1E14

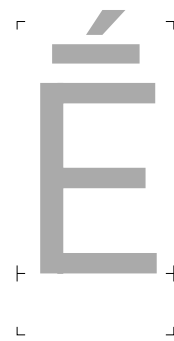

Emacronacute 1E16



Ecircumflexbelow 1E18



Etildebelow 1E1A



Ecedillabreve 1E1C

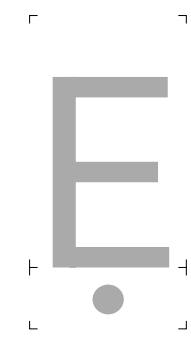

Edotbelow 1EB8



Ehookabove 1EBA



Etilde 1EBC



Ecircumflexacute 1EBE



Ecircumflexgrave 1EC0

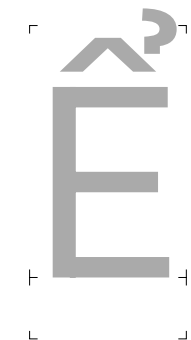

Ecircumflexhookabove 1EC2



Ecircumflextilde 1EC4



Ecircumflexdotbelow 1EC6

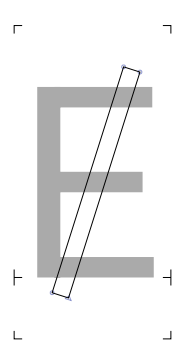

uni0246 0246

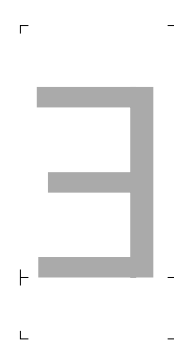

Eturn 018E

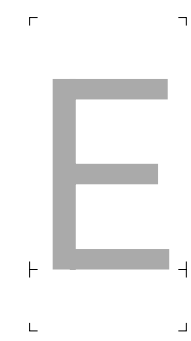

Epsilon 0395



Epsilontonos 0388



uni1F18 1F18



uni1F19 1F19



uni1F1A 1F1A



uni1F1B 1F1B



uni1F1C 1F1C



uni1F1D 1F1D



uni1F18 1F18



uni1F1A 1F1A

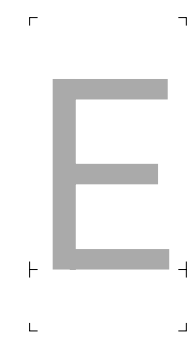

afii10022 0415



uni0400 0400



afii10023 0401



lebrevecyrillic 04D6

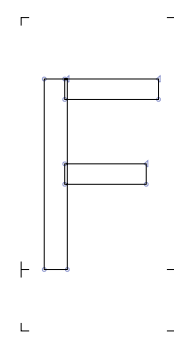

F 0046



Fhook 0191



Fdotaccent 1E1E



Fturn 2132

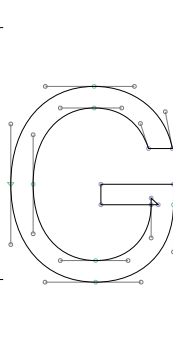

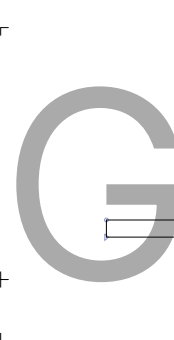

G 0047

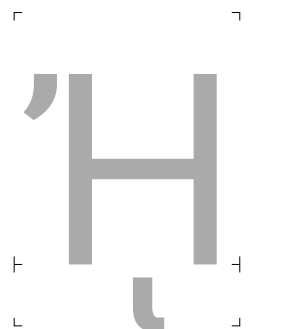
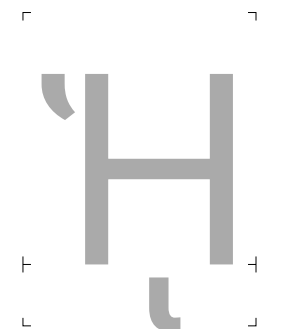
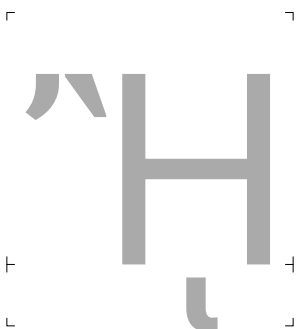
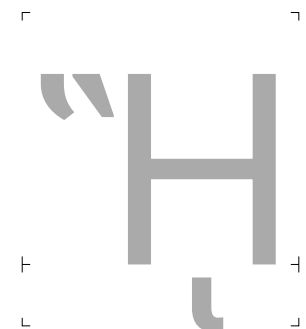

Gbar 01E4

				
Ghook 0193	Gcircumflex 011C	Gbreve 011E	Gdotaccent 0120	Gcommaaccent 0122
				
Gcaron 01E6	Gacute 01F4	Gmacron 1E20	H 0048	Hcedilla 1E28
				
Hcircumflex 0124	uni021E 021E	Hdotaccent 1E22	Hdotbelow 1E24	Hdieresis 1E26
				
Hbrevebelow 1E2A	Hbar 0126	Enhookcyrillic 04C7	Endescendercyrillic 04A2	uni04C9 04C9
				
Enghecyrillic 04A4	uni01F6 01F6	Eta 0397	Eatonos 0389	uni1F28 1F28
				
uni1F29 1F29	uni1F2A 1F2A	uni1F2B 1F2B	uni1F2C 1F2C	uni1F2D 1F2D
				
uni1F2E 1F2E	uni1F2F 1F2F	uni1FCA 1FCA	uni1FCB 1FCB	afii10031 041D

 uni1F98 1F98	 uni1F99 1F99	 uni1F9A 1F9A	 uni1F9B 1F9B	 uni1F9C 1F9C
---	---	--	---	---

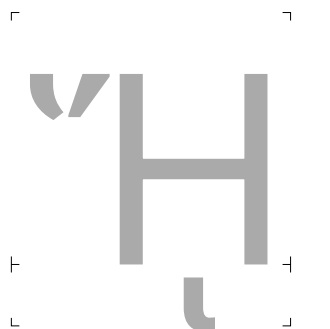
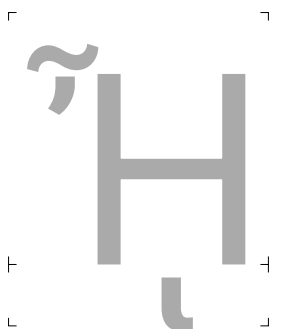
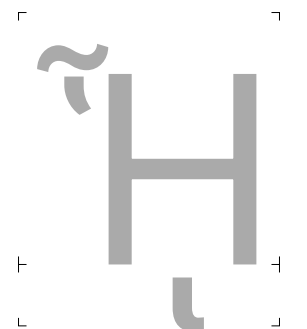
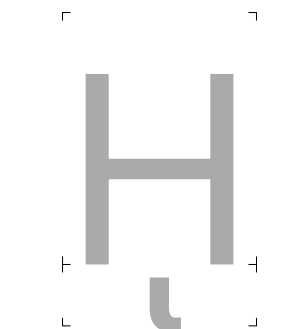
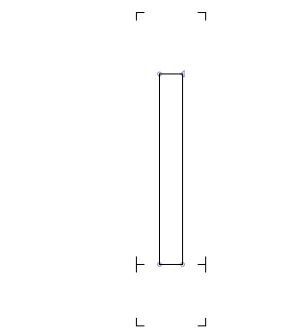
 uni1F9D 1F9D	 uni1F9E 1F9E	 uni1F9F 1F9F	 uni1FCC 1FCC	 0049
---	---	--	---	---

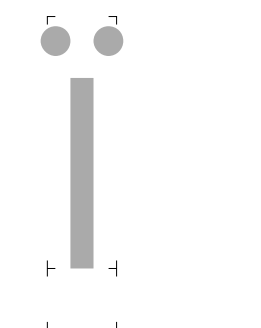
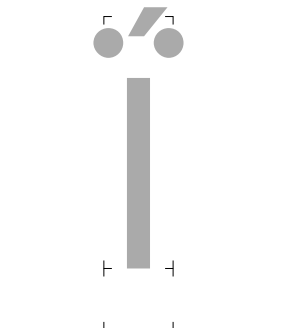
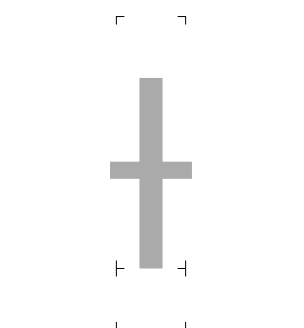
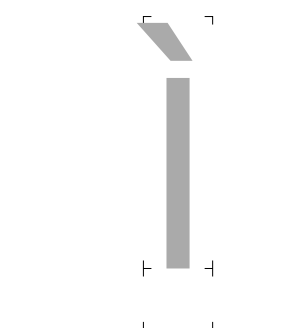
 Idieresis 00CF	 Idieresisacute 1E2E	 Istroke 0197	 Itildebelow 1E2C	 Igrave 00CC
--	---	---	--	---

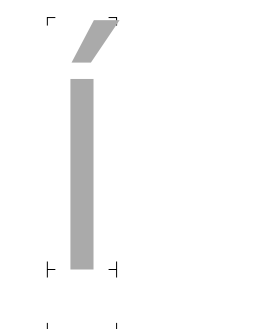
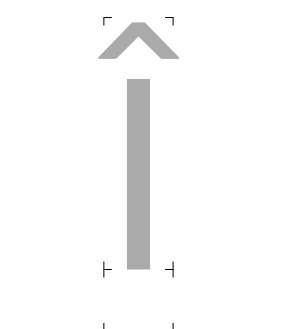
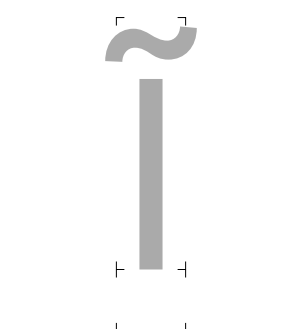
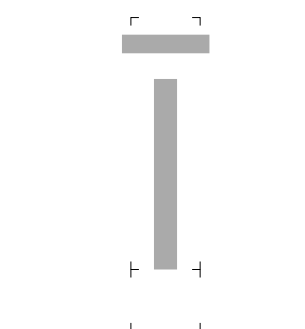
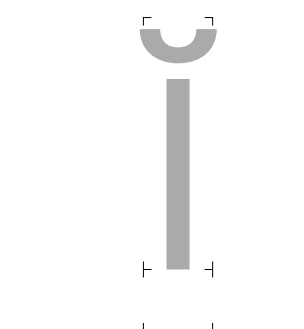
 Iacute 00CD	 Icircumflex 00CE	 Itilde 0128	 Imacron 012A	 Ibreve 012C
--	---	---	---	--

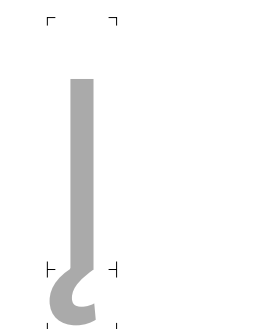
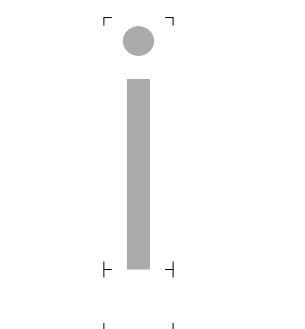
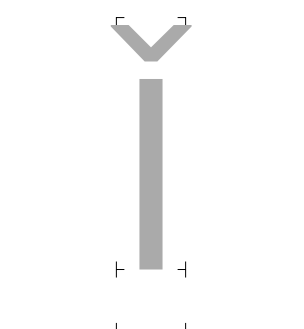
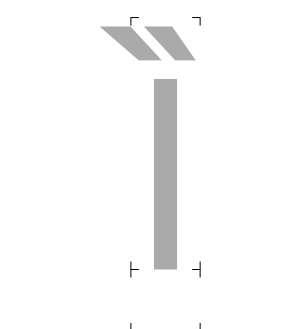
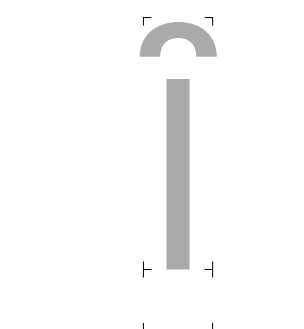
 Iogonek 012E	 Idotaccent 0130	 Icaron 01CF	 Idblgrave 0208	 Iinvertedbreve 020A
---	--	---	---	--

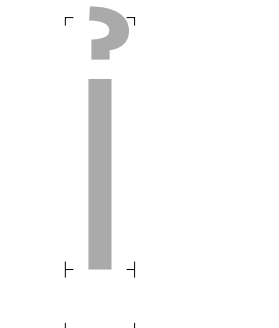
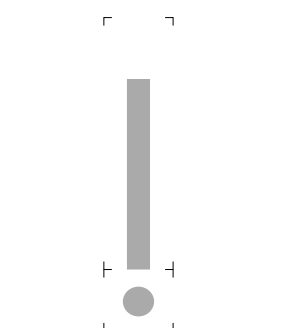
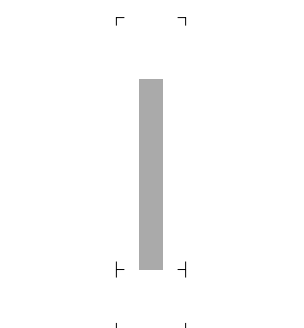
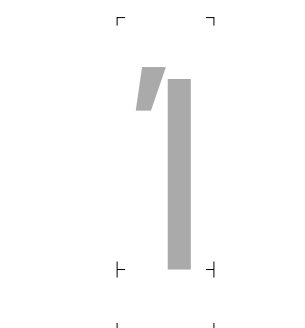
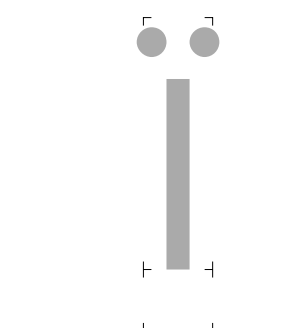
 Ihookabove 1EC8	 Idotbelow 1ECA	 Iota 0399	 Iotatonos 038A	 Iotadieresis 03AA
--	---	---	---	--

 uni1F38 1F38	 uni1F39 1F39	 uni1F3A 1F3A	 uni1F3B 1F3B	 uni1F3C 1F3C
---	---	--	---	---



uni1F3D 1F3D



uni1F3E 1F3E



uni1F3F 1F3F

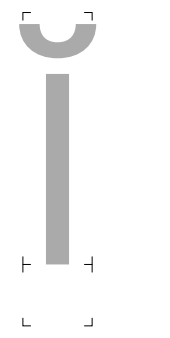

uni1FD8 1FD8



uni1FD9 1FD9

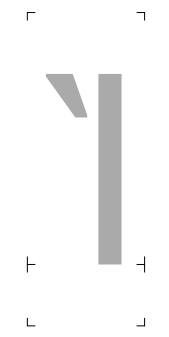

uni1FDA 1FDA



uni1FDB 1FDB

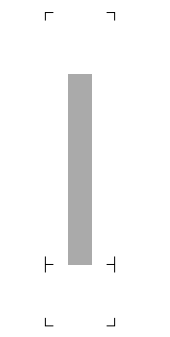

afii10055 0406

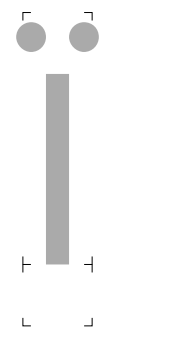

afii10056 0407

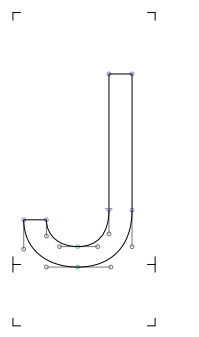

J 004A



Jcircumflex 0134



uni0248 0248



uni037F 037F



afii10057 0408

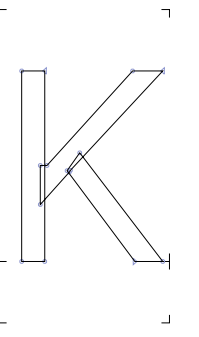

K 004B



Kcommaaccent 0136

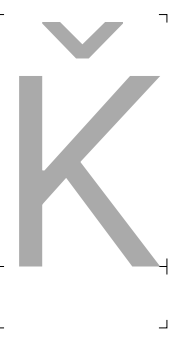

Kcaron 01E8



Kacute 1E30



Kdotbelow 1E32

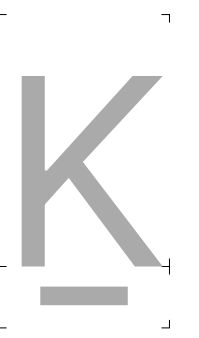

Klinebelow 1E34



Kabashkircyrillic 04A0

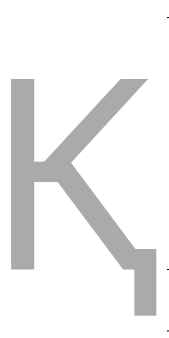

Kadescendcyrillic 049A

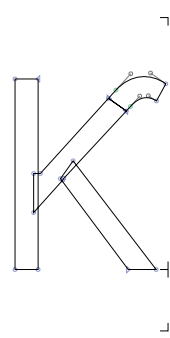

Khook 0198



Kappa 039A

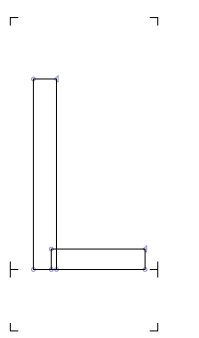

L 004C



Lacute 0139

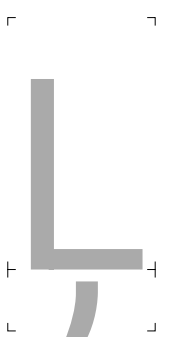

Lcommaaccent 013B



Lcaron 013D

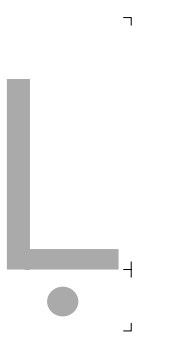

Ldotbelow 1E36

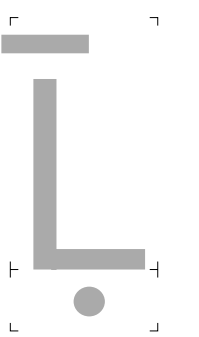

Ldotbelowmacron 1E38

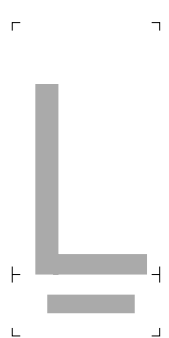

Llinebelow 1E3A

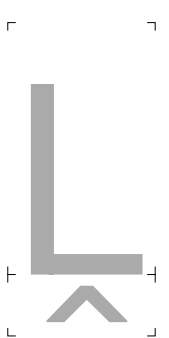

Lcircumflexbelow 1E3C

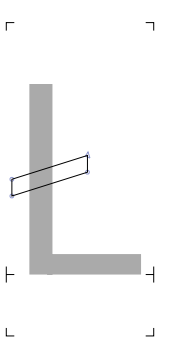

Lslash 0141



Lbar 023D



Lj 01C8

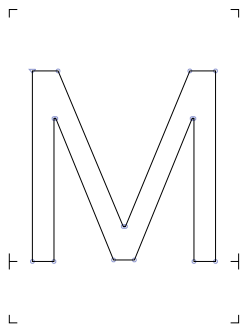

M 004D



Macute 1E3E

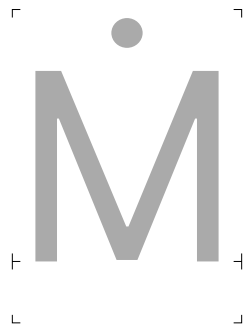

Mdotaccent 1E40

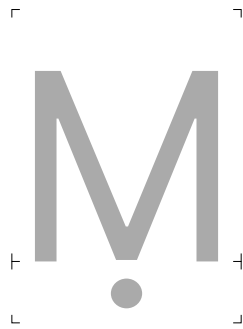

Mdotbelow 1E42



uni04CD 04CD

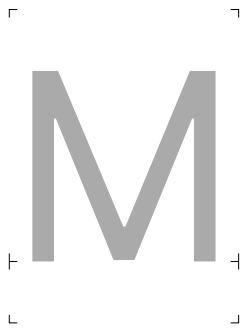

Mu 039C



uni03FA 03FA



afii10030 041C

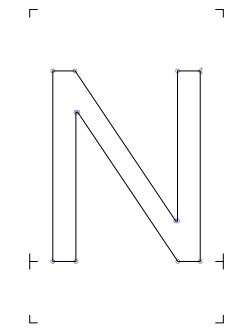

N 004E



Ntilde 00D1



Nacute 0143



Ncommaaccent 0145



Ncaron 0147

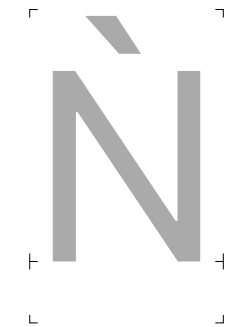

uni01F8 01F8



Ndotaccent 1E44



Ndotbelow 1E46

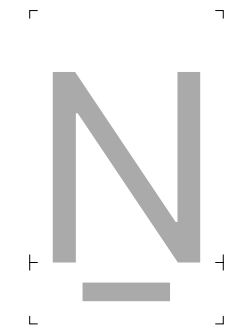

Nlinebelow 1E48



Ncircumflexbelow 1E4A

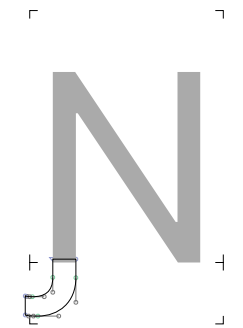

Nhook 019D

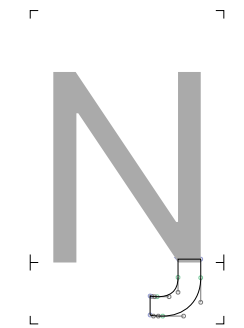

Eng 014A



afii10026 0418

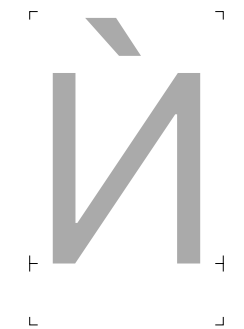

uni040D 040D



afii10027 0419

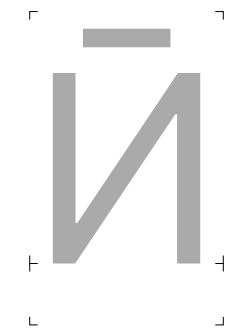

Imacroncyrillic 04E2



Idieresiscyrillic 04E4

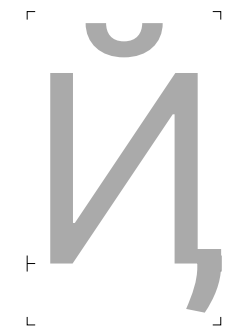

uni048A 048A



uni0376 0376



Nu 039D



Nj 01CB

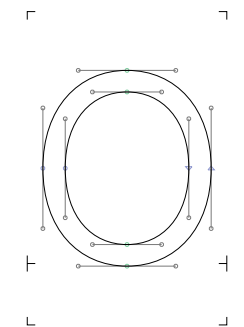

O 004F

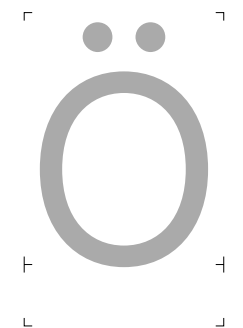

Odieresis 00D6

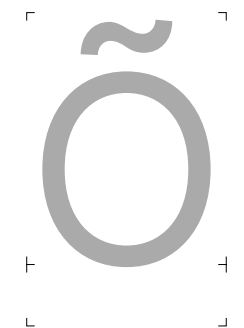

Otilde 00D5

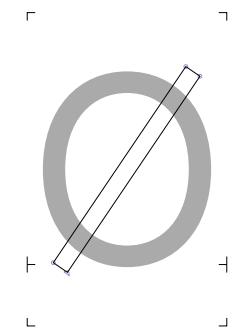



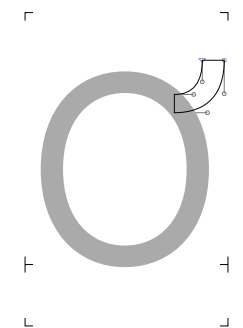



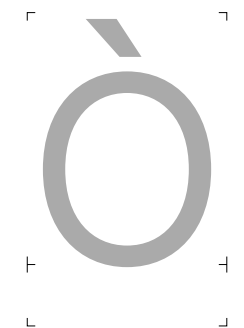



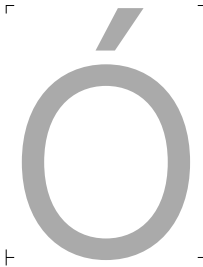
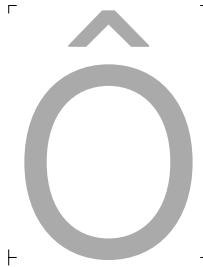
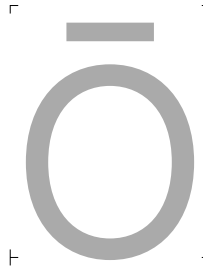
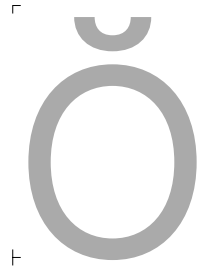

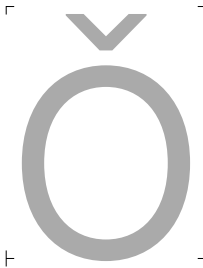
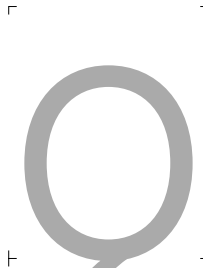
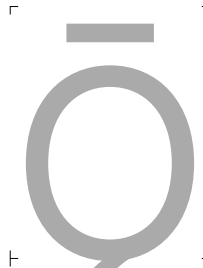
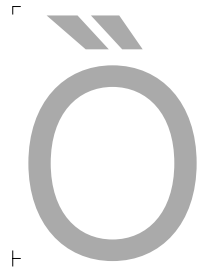

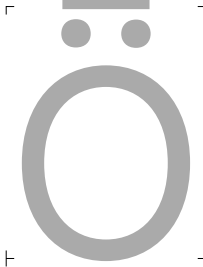

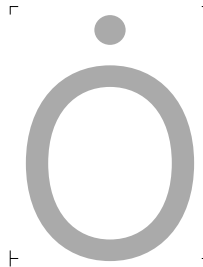
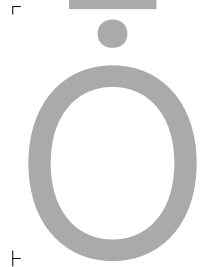
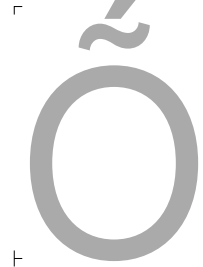
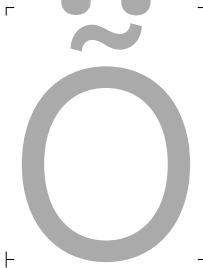
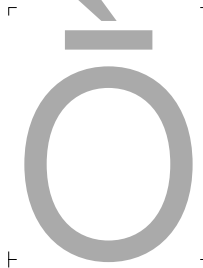
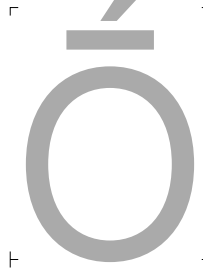
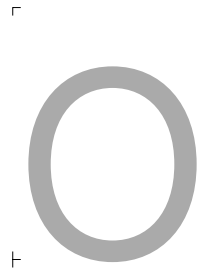
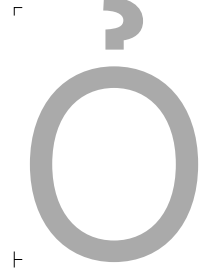
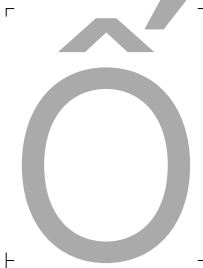
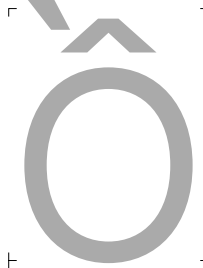
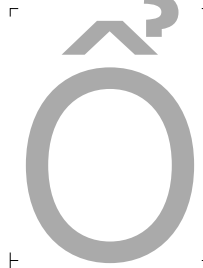
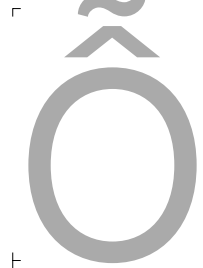
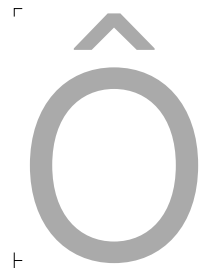
Oslash 00D8

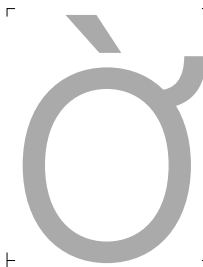

Ohorn 01A0

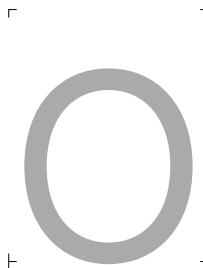

Ograve 00D2

				
Oacute 00D3	Ocircumflex 00D4	Omacron 014C	Obreve 014E	Ohungarumlaut 0150
				
Ocaron 01D1	Oogonek 01EA	Oogonekmacron 01EC	Odblgrave 020C	Oinvertedbreve 020E
				
uni022A 022A	uni022C 022C	uni022E 022E	uni0230 0230	Otildeacute 1E4C
				
Otildedieresis 1E4E	Omacrongrave 1E50	Omacronacute 1E52	Odotbelow 1ECC	Ohookabove 1ECE
				
Ocircumflexacute 1ED0	Ocircumflexgrave 1ED2	Ocircumflexhookabove 1ED4	Ocircumflextilde 1ED6	Ocircumflexdotbelow 1ED8
				
Ohornacute 1EDA	Ohorngrave 1EDC	Ohornhookabove 1EDE	Ohorntilde 1EE0	Ohorndotbelow 1EE2
				
Oslashacute 01FE	Omicron 039F	Omicrontonos 038C	uni1F48 1F48	uni1F49 1F49

uni1F4A 1F4A	uni1F4B 1F4B	uni1F4C 1F4C	uni1F4D 1F4D	uni1FF8 1FF8
uni03F4 03F4	uni1FF9 1FF9	afii10032 041E	Odiereiscyrillic 04E6	Obar 019F
Obarredcyrillic 04E8	Obarreddiereiscyrillic 04EA	OE 0152	P 0050	Pacute 1E54
Pdotaccent 1E56	uni048E 048E	Phook 01A4	Rho 03A1	uni1FEC 1FEC
Q 0051	R 0052	Racute 0154	Rcommaaccent 0156	Rcaron 0158
Rdblgrave 0210	Rinvertedbreve 0212	Rdotaccent 1E58	Rdotbelow 1E5A	Rdotbelowmacron 1E5C
Rlinebelow 1E5E	response 211F	Rx 211E	uni024C 024C	S 0053



Sacute 015A



Scircumflex 015C



Scedilla 015E



Scaron 0160



Scommaaccent 0218



Sdotaccent 1E60



Sdotbelow 1E62



Sacutedotaccent 1E64



Scarondotaccent 1E66



Sdotbelowdotaccent 1E68

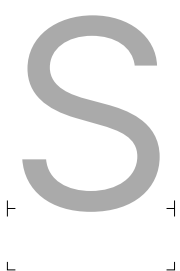

afii10054 0405

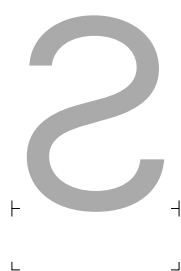

Tonetwo 01A7

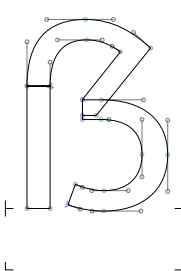

Germandbls 1E9E

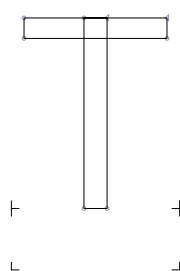

T 0054

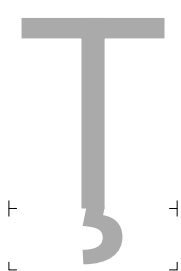

Tcommaaccent 0162

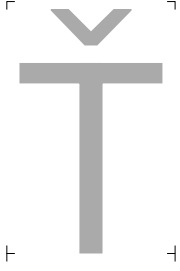

Tcaron 0164

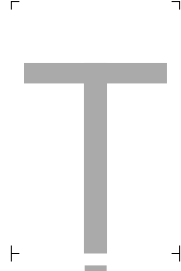

uni021A 021A

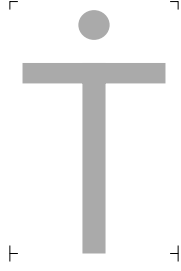

Tdotaccent 1E6A

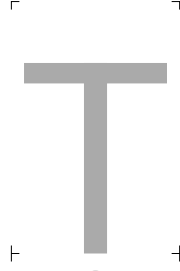

Tdotbelow 1E6C

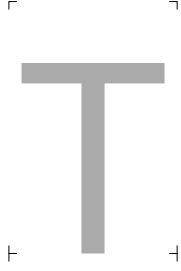

Tlinebelow 1E6E



Tcircumflexbelow 1E70

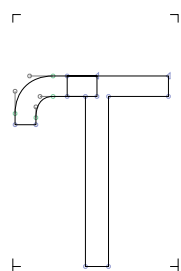

Thook 01AC

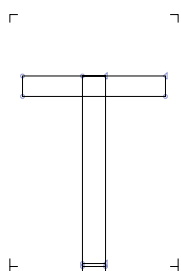

Trhook 01AE

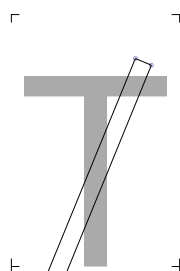

uni023E 023E



Tau 03A4

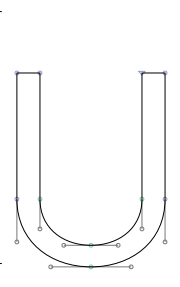

U 0055

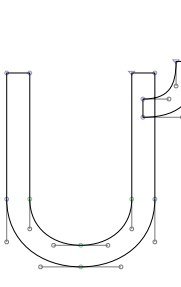

Uhorn 01AF



Ugrave 00D9



Uacute 00DA

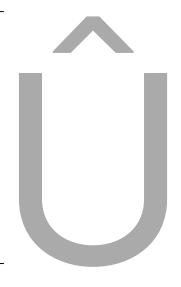

Ucircumflex 00DB

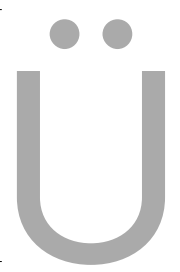

Udieresis 00DC



Utilde 0168



Umacron 016A



Ubreve 016C

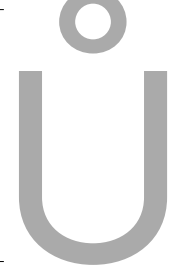

Uring 016E



Uhungarumlaut 0170



Uogonek 0172



Ucaron 01D3



Udieresismacron 01D5



Udieresisacute 01D7

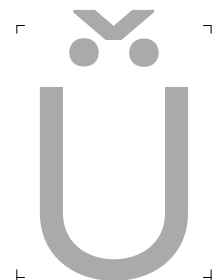

Udieresiscaron 01D9



Udieresisgrave 01DB



Udblgrave 0214



Uinvertedbreve 0216



Udieresisbelow 1E72

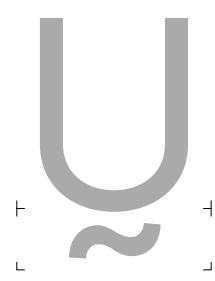

Utildebelow 1E74

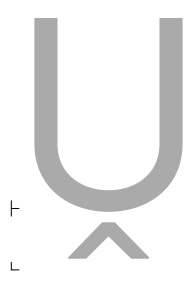

Ucircumflexbelow 1E76



Utildeacute 1E78



Umacrondieresis 1E7A

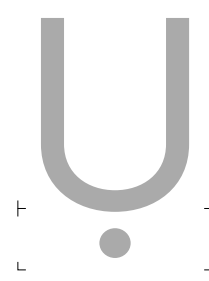

Udotbelow 1EE4

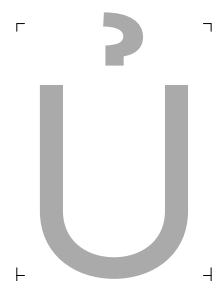

Uhookabove 1EE6



Uhornacute 1EE8



Uhorngrave 1EEA



Uhornhookabove 1EEC



Uhorntilde 1EEE

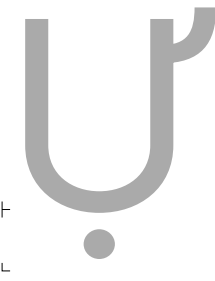

Uhornndotbelow 1EF0

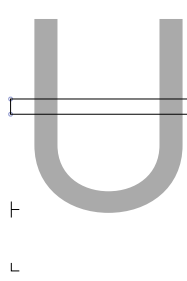

uni0244 0244

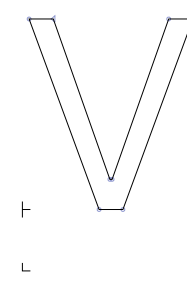

V 0056

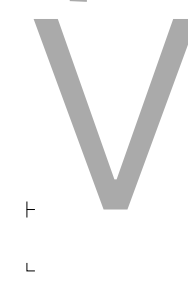

Vtilde 1E7C

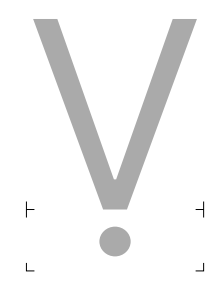

Vdotbelow 1E7E

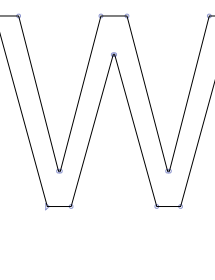

W 0057



Wcircumflex 0174



Wgrave 1E80



Wacute 1E82



Wdieresis 1E84



Wdotaccent 1E86



Wdotbelow 1E88

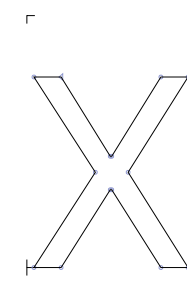

X 0058



Xdotaccent 1E8A



Xdieresis 1E8C

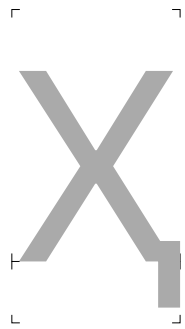

Hadescenderycyrillic 04B2

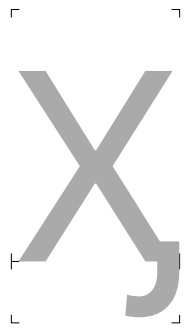

uni04FC 04FC

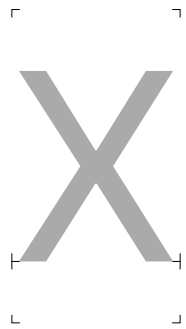

Chi 03A7

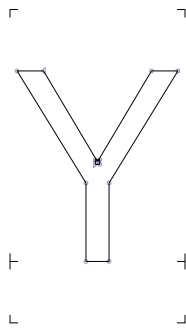

Y 0059

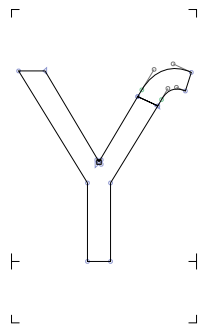

Yhook 01B3



Yacute 00DD

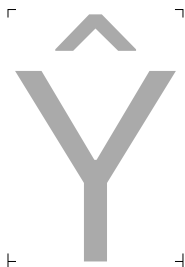

Ycircumflex 0176



Ydieresis 0178

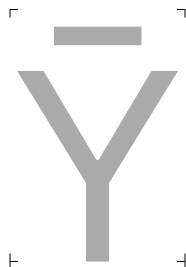

uni0232 0232



Ydotaccent 1E8E



Ygrave 1EF2



Ydotbelow 1EF4



Yhookabove 1EF6



Ytilde 1EF8

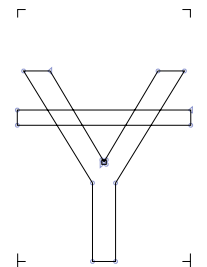

uni024E 024E



Upsilon 03A5



Upsilontonos 038E



Upsilondieresis 03AB

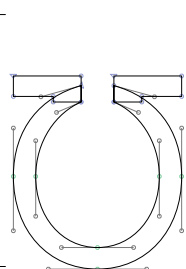

Upsilon2 01B1

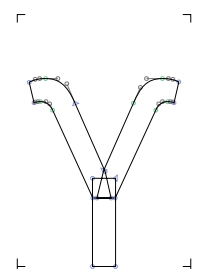

Upsilonhooksymbol 03D2



Upsilonacutehooksymbolgreek 03D3



Upsilondieresishooksymbolgreek 03D4



uni1F59 1F59



uni1F5B 1F5B



uni1F5D 1F5D

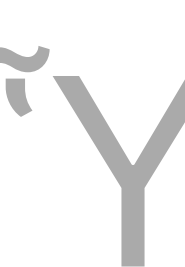

uni1F5F 1F5F



uni1FE8 1FE8

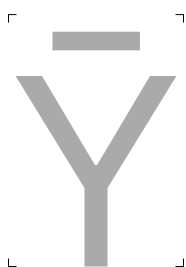

uni1FE9 1FE9



uni1FEA 1FEA



uni1FEB 1FEB

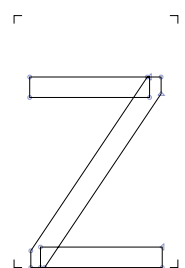

Z 005A



Zacute 0179



Zdotaccent 017B



Zcaron 017D



Zcircumflex 1E90



Zdotbelow 1E92



Zlinebelow 1E94

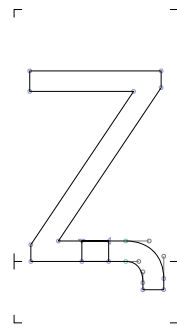

uni0224 0224



Zbar 01B5



Zeta 0396

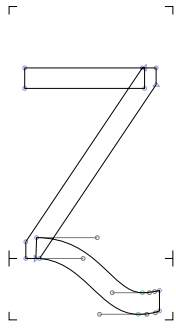

uni2C7F 2C7F

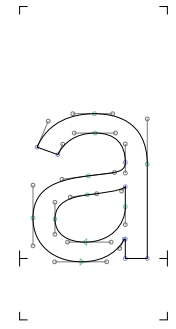

a 0061



adieresis 00E4



atilde 00E3



arighthalfring 1E9A



agrave 00E0



acute 00E1



acircumflex 00E2



aring 00E5



amacron 0101



abreve 0103



aogonek 0105



acaron 01CE



adieresismacron 01DF



adotmacron 01E1



aringacute 01FB



adblgrave 0201



ainvertedbreve 0203



uni0227 0227



aringbelow 1E01



adotbelow 1EA1



ahookabove 1EA3



acircumflexacute 1EA5



acircumflexgrave 1EA7



acircumflexhookabove 1EA9



acircumflextilde 1EAB



acircumflexdotbelow 1EAD



abreveacute 1EAF



abrevegrave 1EB1



abrevehookabove 1EB3



abrevetilde 1EB5



abrevedotbelow 1EB7

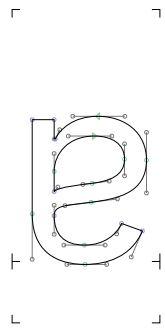

aturn 0250



afii10065 0430



abrevicyrillic 04D1



adieresiscyrillic 04D3

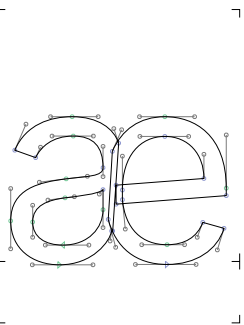

ae 00E6



aemacron 01E3



aeacute 01FD



aiecyrillic 04D5

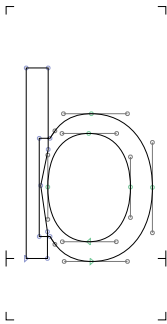

b 0062



bbar 0180

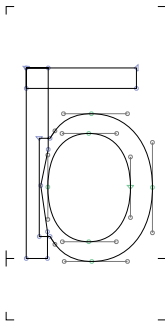

btopbar 0183

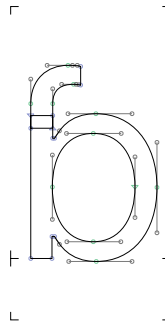

bhook 0253



bdotaccent 1E03



bdotbelow 1E05



blinebelow 1E07

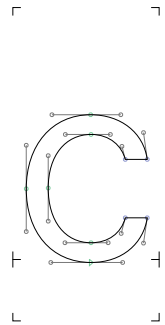

c 0063

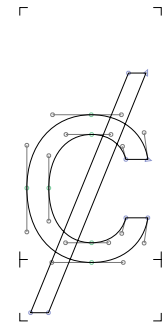

uni023C 023C

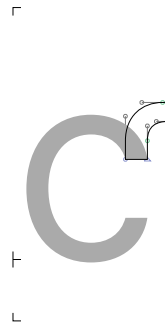

chook 0188

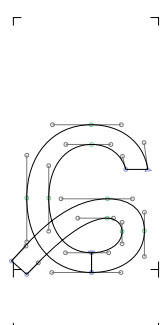

ccurl 0255



ccedilla 00E7



cacute 0107



ccircumflex 0109

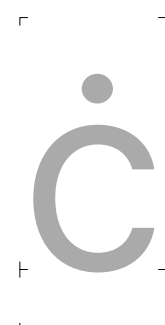

cdotaccent 010B



ccaron 010D



ccedillaacute 1E09



sigmalunatesymbolgreek 03F2



escyrillic 0441



d 0064



dcroat 0111

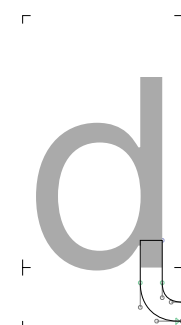

drhook 0256

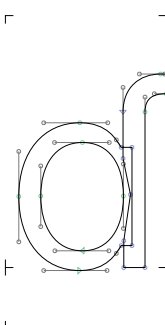

dhook 0257

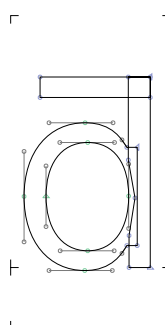

dtopbar 018C

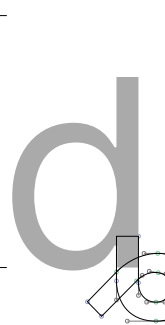

uni0221 0221



dcaron

010F



ddotaccent

1E0B



ddotbelow

1E0D



dlinebelow

1E0F



dcedilla

1E11



dcircumflexbelow

1E13



dz

02A3



dzcaron

01C6



dzcurl

02A5

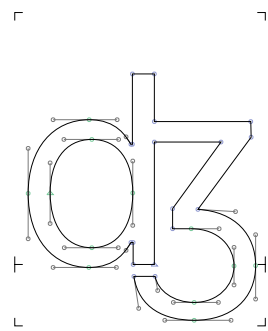

dyogh

02A4



dong

20AB

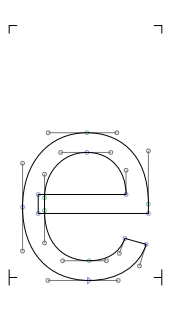

e

0065



edieresis

00EB

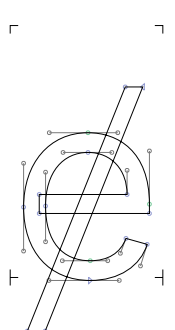

uni0247

0247



egrave

00E8

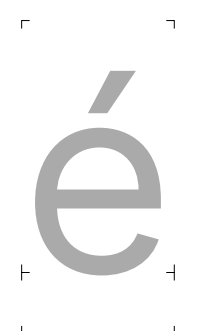

eacute

00E9



ecircumflex

00EA



emacron

0113



ebreve

0115



edotaccent

0117



eogonek

0119



ecaron

011B



edblgrave

0205

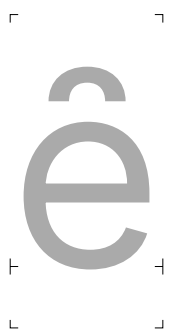

einvertedbreve

0207



uni0229

0229

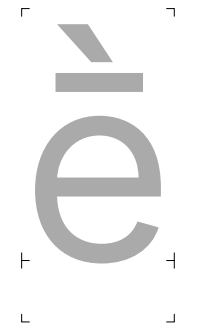

emacrongrave

1E15



emacronacute

1E17



ecircumflexbelow

1E19



etildebelow

1E1B



ecedillabreve

1E1D



edotbelow

1EB9

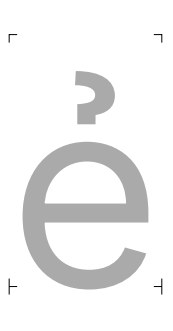

ehookabove

1EBB

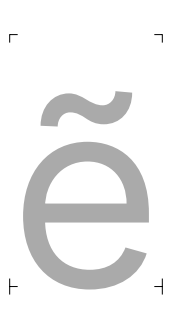

etilde

1EBD

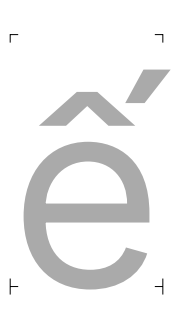

ecircumflexacute

1EBF

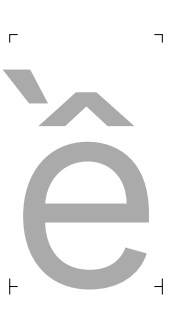

ecircumflexgrave

1EC1



ecircumflexhookabove 1EC3



ecircumflexilde 1EC5



ecircumflexdotbelow 1EC7



iecyrillic 0435



uni0450 0450



io Cyrillic 0451



iebrevecyrillic 04D7



eturn 01DD

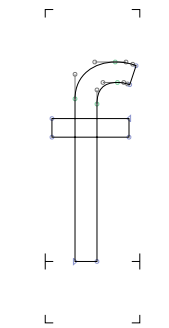

f 0066

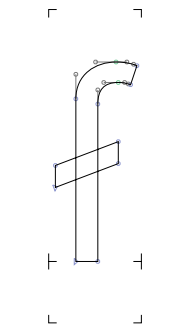

slongstroke 1E9C

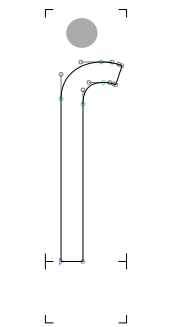

slongdotaccent 1E9B



fdotaccent 1E1F



feng 02A9

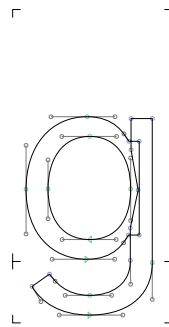

g 0067

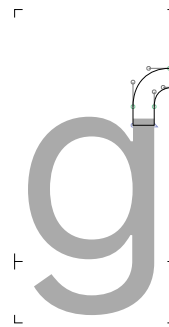

ghook 0260



gbar 01E5



gcircumflex 011D



gbreve 011F



gdotaccent 0121



gcommaaccent 0123



gcaron 01E7



gacute 01F5



gmacron 1E21

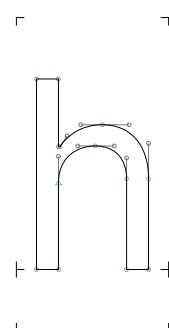

h 0068



hcedilla 1E29



tshechyrillic 045B

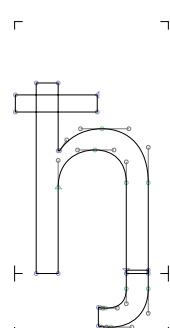

djecyrillic 0452

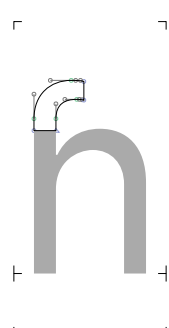

hhook 0266



henghook 0267

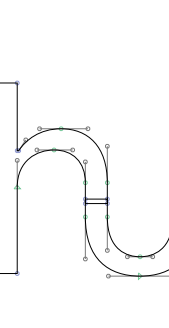

hv 0195



hturn 0265

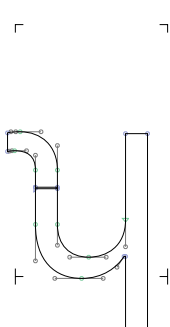

hturnlthook 02AE

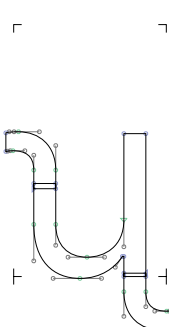

hturnhook2 02AF



hbar 0127



hcircumflex 0125



uni021F

021F



hdotaccent

1E23



hdotbelow

1E25



hdieresis

1E27



hbrevebelow

1E2B



hlinebelow

1E96



shhacryllic

04BB

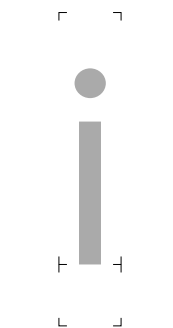

i

0069

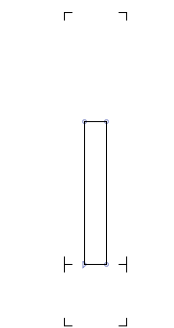

idotless

0131

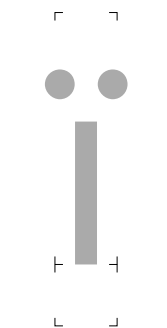

idieresis

00EF

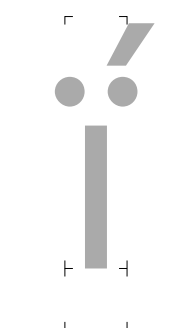

idieresisacute

1E2F



itilde

0129

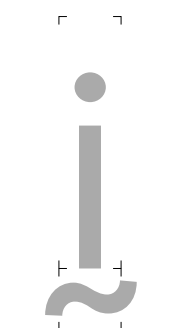

itildebelow

1E2D

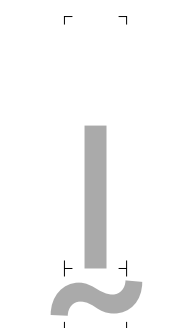

uni1E2D.ccmp

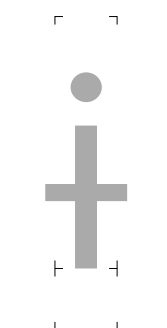

ibar

0268

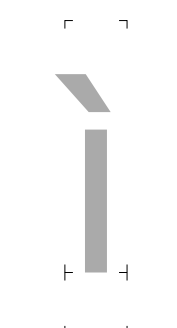

igrave

00EC



iacute

00ED

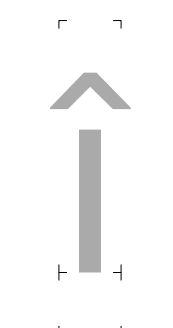

icircumflex

00EE



imacron

012B

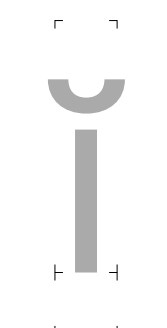

ibreve

012D

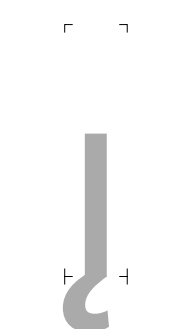

uni012F.ccmp



iogonek

012F



icaron

01D0



idblgrave

0209

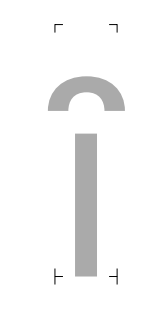

iivertedbreve

020B



ihookabove

1EC9



idotbelow

1ECB



uni1ECB.ccmp

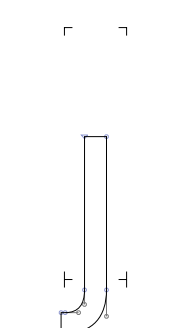

jdotless

0237

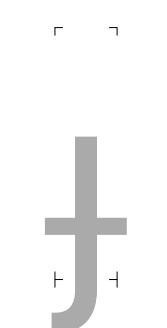

jdotlessbar

025F



uni0249

0249



uni0249.ccmp



icyrillic

0456



yicyrillic

0457



ij

0133



j 006A



jcrosstail.ccmp



jcrosstail 029D



jcircumflex 0135



jcaron 01F0



yotgreek 03F3



jecyrillic 0458



lj 01C9

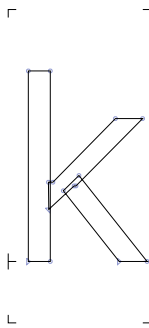

k 006B

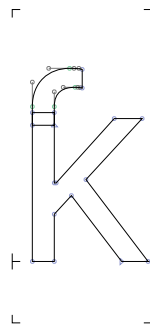

khook 0199



kcommaaccent 0137

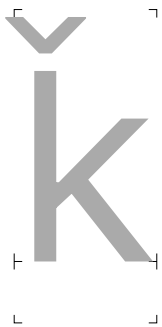

kcaron 01E9

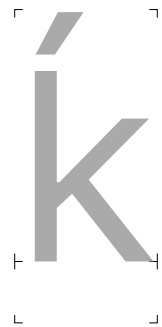

kacute 1E31



kdotbelow 1E33



klinebelow 1E35

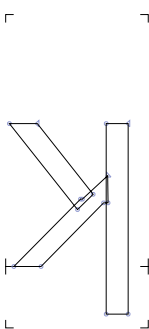

kturn 029E

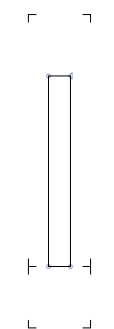

l 006C

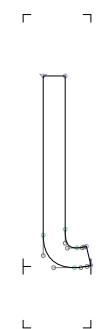

l.ss02

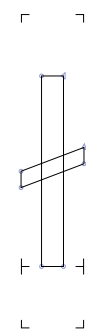

lslash 0142

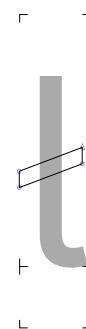

lslash.ss02



lbar 019A



lbar.ss02



lmidtilde 026B



lmidtilde.ss02



lrhook 026D

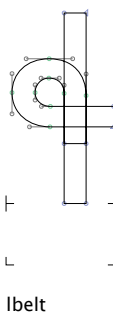

lbelt 026C

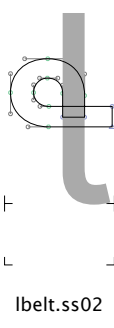

lbelt.ss02

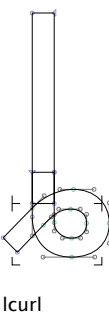

lcurl 0234

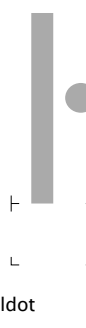

ldot 0140

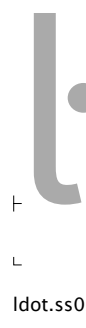

ldot.ss02



lacute 013A



lacute.ss02

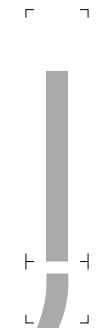

lcommaaccent 013C



lcommaaccent.ss02



lcaron 013E



lcaron.ss02



ldotbelow

1E37



ldotbelow.ss02



ldotbelowmacron

1E39



ldotbelowmacron.ss02

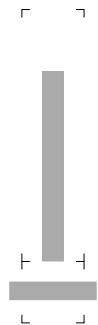

llinebelow

1E3B



llinebelow.ss02



lcircumflexbelow

1E3D



lcircumflexbelow.ss02



uni04CF

04CF

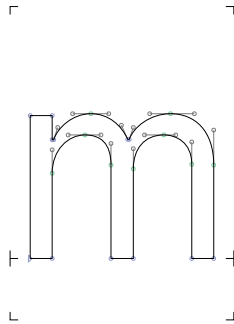

m

006D

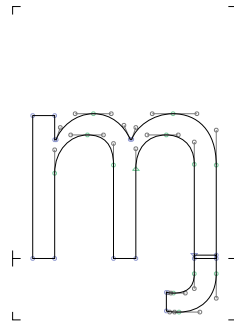

mhook

0271



mturn

026F

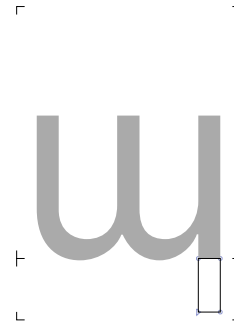

mturndescend

0270

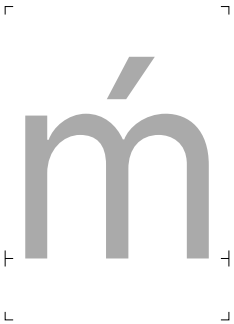

macute

1E3F



mdotaccent

1E41



mdotbelow

1E43

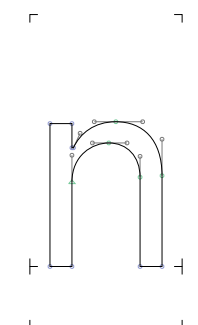

n

006E



ntilde

00F1

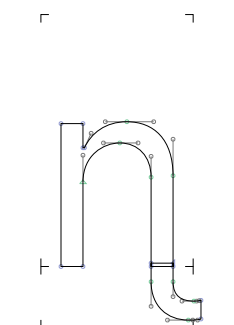

nrthook

0273

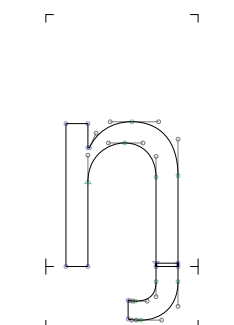

eng

014B

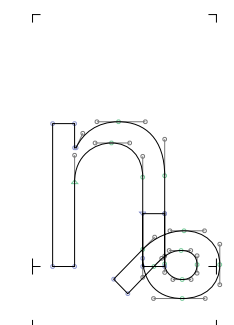

ncurl

0235

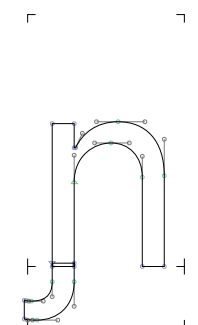

nlftthook

0272

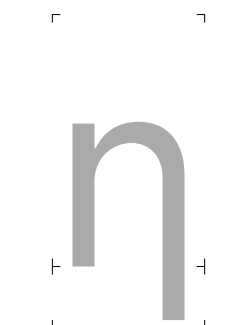

nlegrightlong

019E

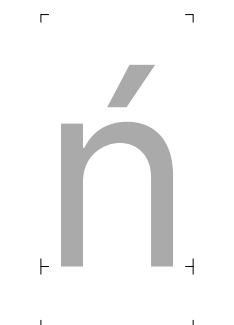

nacute

0144

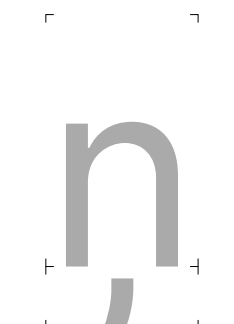

ncommaaccent

0146

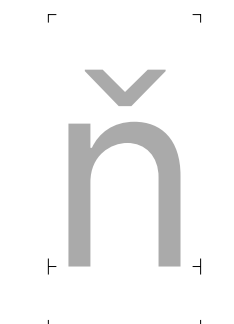

ncaron

0148

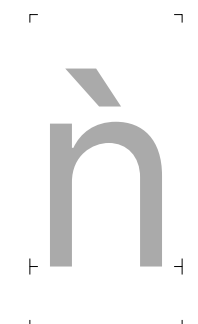

uni01F9

01F9



ndotaccent

1E45

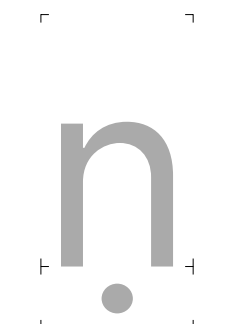

ndotbelow

1E47

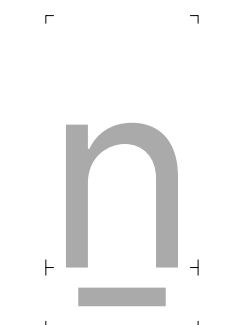

nlinebelow

1E49

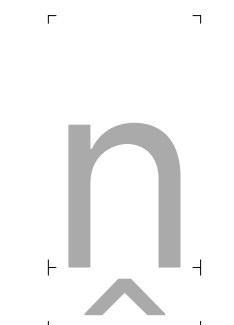

ncircumflexbelow

1E4B



nj

01CC

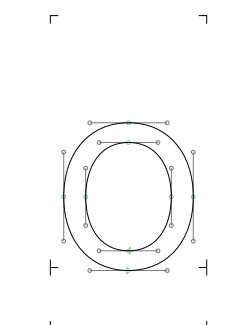





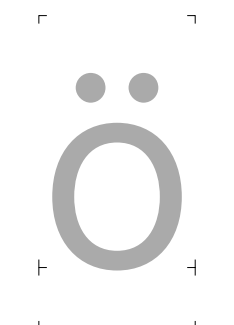





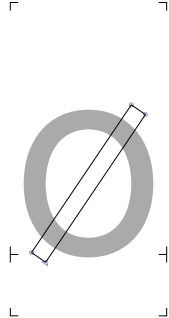
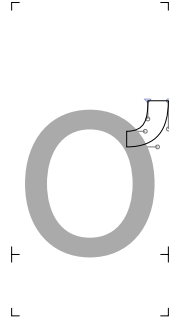

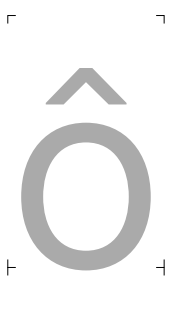

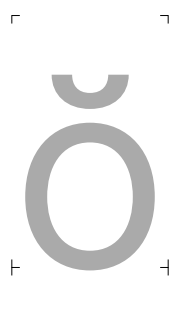

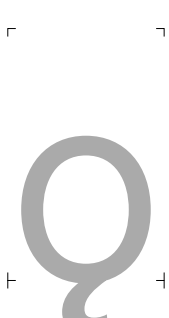



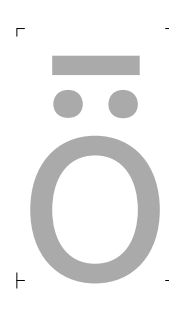

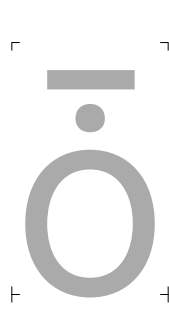

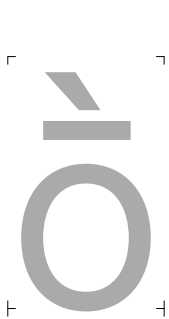

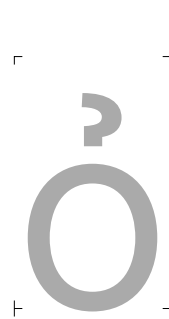

o

006F



odieresis

00F6

				
otilde 00F5	oslash 00F8	ohorn 01A1	ograve 00F2	oacute 00F3
				
ocircumflex 00F4	omacron 014D	obreve 014F	ohungarumlaut 0151	ocaron 01D2
				
oogonek 01EB	oogonekmacron 01ED	odblgrave 020D	oinvertedbreve 020F	uni022B 022B
				
uni022D 022D	uni022F 022F	uni0231 0231	otildeacute 1E4D	otildedieresis 1E4F
				
omacrongrave 1E51	omacronacute 1E53	odotbelow 1ECD	ohookabove 1ECF	ocircumflexacute 1ED1
				
ocircumflexgrave 1ED3	ocircumflexhookabove 1ED5	ocircumflextilde 1ED7	ocircumflexdotbelow 1ED9	ohornacute 1EDB
				
ohorngrave 1EDD	ohornhookabove 1EDF	ohorntilde 1EE1	ohorndotbelow 1EE3	oslashacute 01FF

omeron 03BF omicrontonos 03CC uni1F40 1F40 uni1F41 1F41 uni1F42 1F42

uni1F43 1F43 uni1F44 1F44 uni1F45 1F45 uni1F78 1F78 fitacyrillic 0473

obar 0275 ocyrillic 043E odieresiscyrillic 04E7 oe 0153 ukcyrillic 0479

p 0070 uni048F 048F phook 01A5 pacute 1E55 pdotaccent 1E57

ercyrillic 0440 q 0071 qhook 02A0 qrhook 024B Q_rhook 024A

r 0072 rrhook 027D uni024D 024D rturn 0279 rturnrhook 027B

rfishhookrev 027F rfishhook 027E rdescend 027C racute 0155 rcommaaccent 0157



rcaron

0159



rdblgrave

0211



rinvertedbreve

0213



rdotaccent

1E59



rdbelow

1E5B



rdotbelowmacron

1E5D



rlinebelow

1E5F

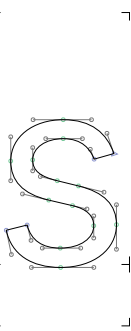

s

0073

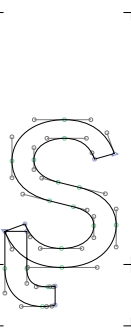

srhook

0282



uni023F

023F



sacute

015B



scircumflex

015D



scedilla

015F



scaron

0161



scommaaccent

0219



sdotaccent

1E61



sdbelow

1E63



sacutedotaccent

1E65



scarondotaccent

1E67



sdbelowdotaccent

1E69



dzecyrillic

0455



tonetwo

01A8

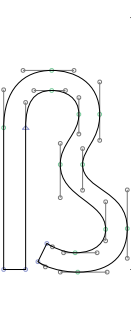

germandbls

00DF

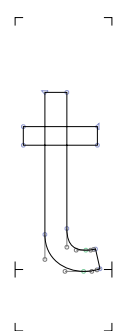

t

0074



tpatalhook

01AB

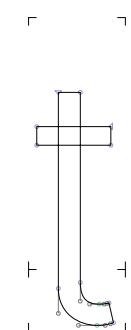

trhook

0288

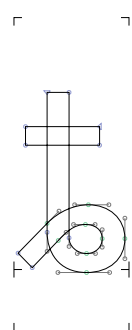

tcurl

0236

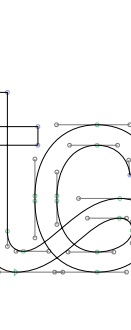

tccurl

02A8



tturn

0287

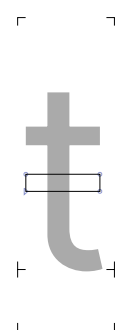

tbar

0167



tcommaaccent

0163



tcaron

0165



uni021B

021B



tdotaccent

1E6B



tdotbelow

1E6D



tlinebelow

1E6F



tcircumflexbelow

1E71



tdieresis

1E97

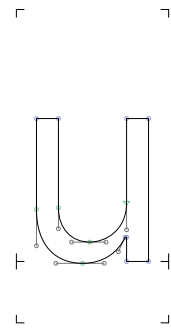

u

0075



udieresis

00FC



utilde

0169

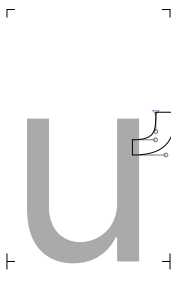

uhorn

01B0

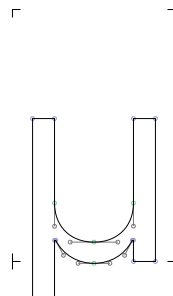

micro

00B5

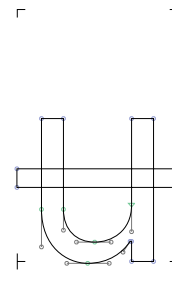

ubar

0289



ugrave

00F9



uacute

00FA



ucircumflex

00FB



umacron

016B



ubreve

016D



uring

016F



uhungarumlaut

0171



uogonek

0173



ucaron

01D4

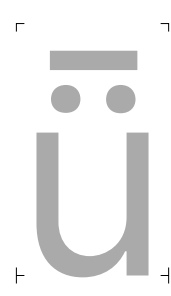

udieresismacron

01D6



udieresisacute

01D8



udieresiscaron

01DA



udieresisgrave

01DC



udblgrave

0215



uinvertedbreve

0217

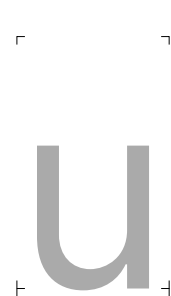

udieresisbelow

1E73



utildebelow

1E75



ucircumflexbelow

1E77



utildeacute

1E79



umacrondieresis

1E7B

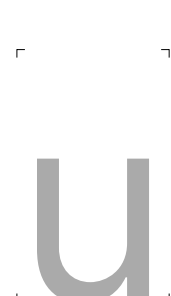

udotbelow

1EE5

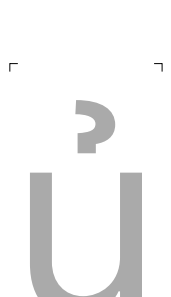

uhookabove

1EE7



uhornacute

1EE9



uhorngrave

1EEB



uhornhookabove

1EED



uhorntilde

1EEF

				
uhorndotbelow 1EF1	v 0076	vturn 028C	vtilde 1E7D	vdotbelow 1E7F
				
w 0077	wdieresis 1E85	wturn 028D	wcircumflex 0175	wgrave 1E81
				
wacute 1E83	wdotaccent 1E87	wdotbelow 1E89	wring 1E98	x 0078
				
xdotaccent 1E8B	xdieresis 1E8D	khacyrillic 0445	y 0079	ydieresis 00FF
				
yhook 01B4	uni024F 024F	yacute 00FD	ycircumflex 0177	uni0233 0233
				
ydotaccent 1E8F	yring 1E99	ygrave 1EF3	ydotbelow 1EF5	yhookabove 1EF7
				
ytilde 1EF9	ucyrillic 0443	ushortcyrillic 045E	umacroncyrillic 04EF	udieresiscyrillic 04F1

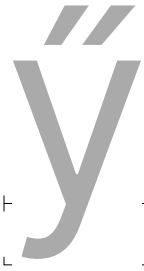

uhungarumlautcyrillic 04F3

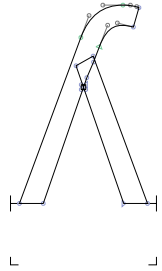

yturn 028E

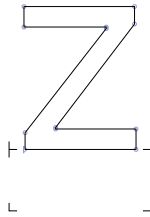

z 007A



zbar 01B6

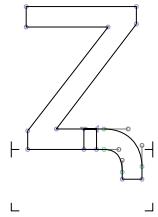

zhook 0225

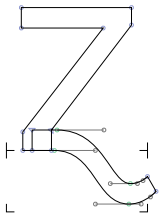

uni0240 0240

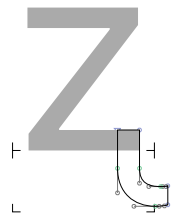

zrthook 0290



zacute 017A



zdotaccent 017C



zcaron 017E



zcircumflex 1E91

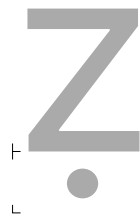

zdotbelow 1E93

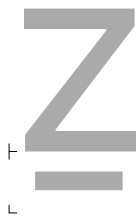

zlinebelow 1E95

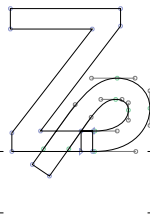

zcurl 0291

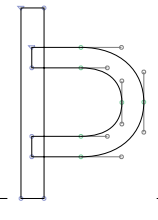

Thorn 00DE



Gamma 0393

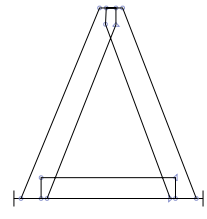

Delta 0394

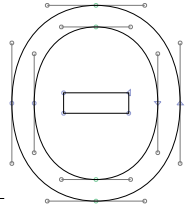

Theta 0398

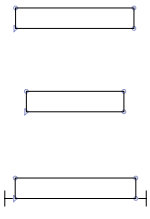

Xi 039E

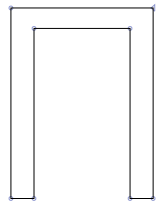

Pi 03A0

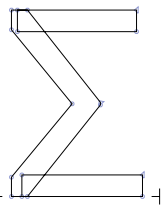

Sigma 03A3

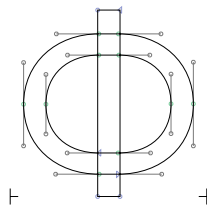

Phi 03A6

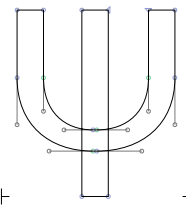

Psi 03A8

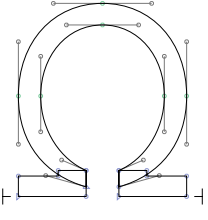

Omega 03A9

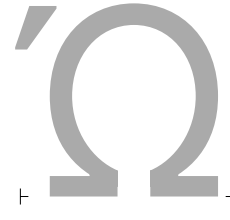

uni1FFB 1FFB



Omegatonos 038F



uni1F68 1F68

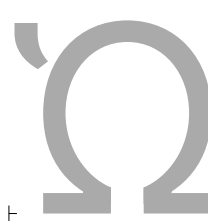

uni1F69 1F69

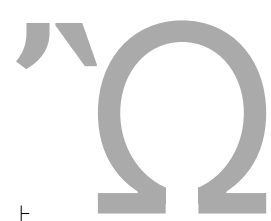

uni1F6A 1F6A

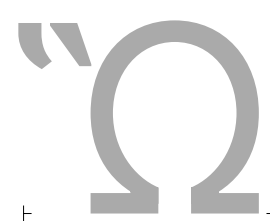

uni1F6B 1F6B

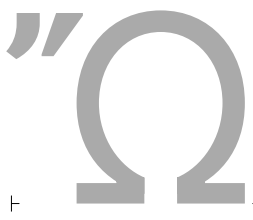

uni1F6C 1F6C

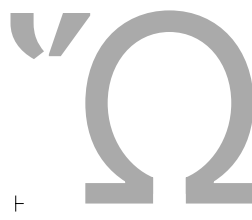

uni1F6D 1F6D

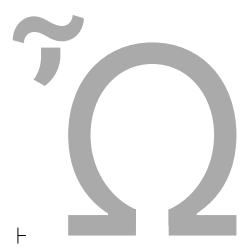

uni1F6E 1F6E

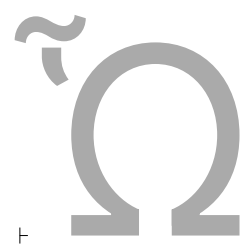

uni1F6F 1F6F

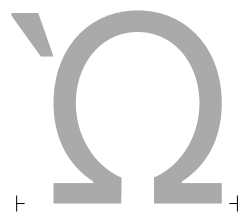

uni1FFA 1FFA

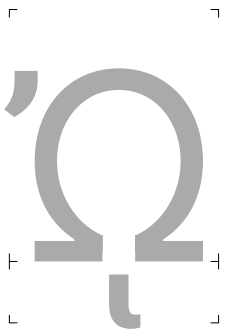

uni1FA8 1FA8

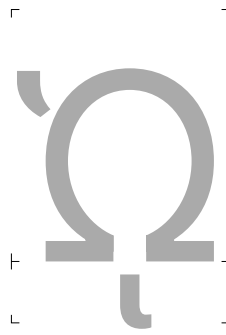

uni1FA9 1FA9

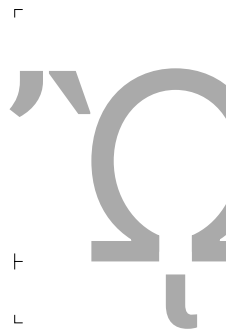

uni1FAA 1FAA

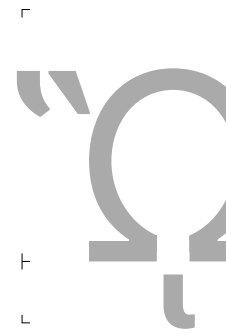

uni1FAB 1FAB



uni1FAC 1FAC

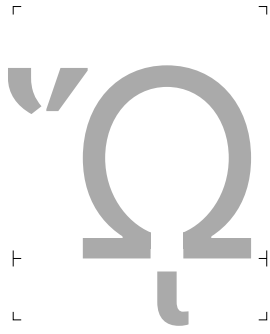

uni1FAD 1FAD

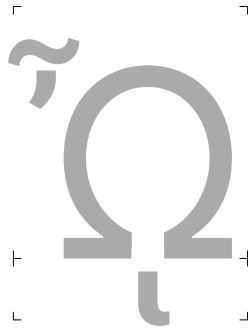

uni1FAE 1FAE

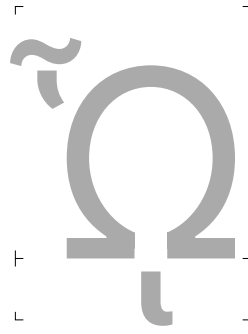

uni1FAF 1FAF



uni1FFC 1FFC

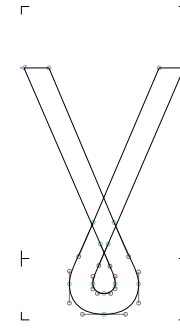

Gamma1 0194



afii10018 0411

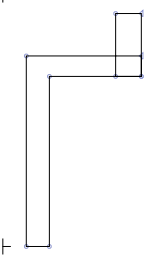

afii10050 0490

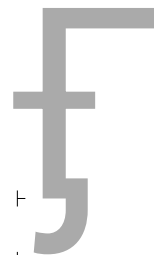

uni04FA 04FA

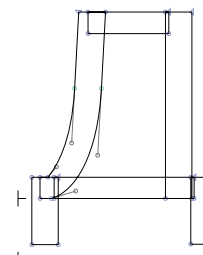

afii10021 0414

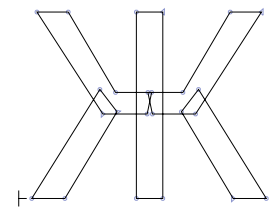

afii10024 0416

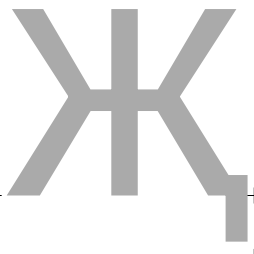

Zhedescendercyrillic 0496

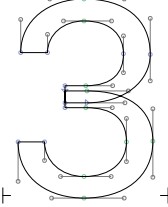

afii10025 0417

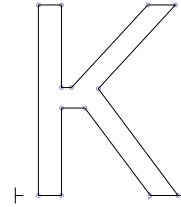

Kacyr 041A

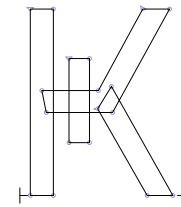

Kaverticalstrokecyrillic 049C

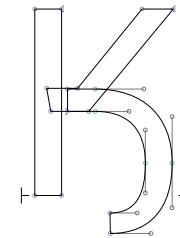

Kahookcyrillic 04C3

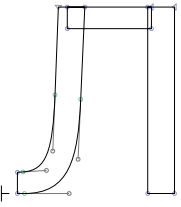

afii10029 041B

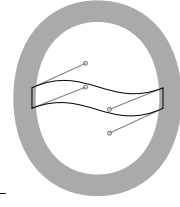

afii10147 0472

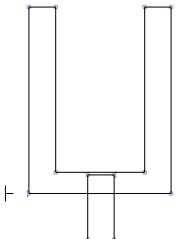

afii10145 040F

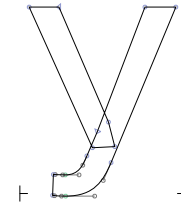

afii10037 0423

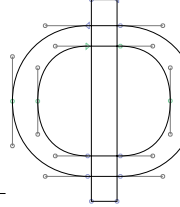

afii10038 0424

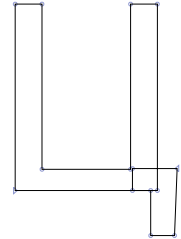

afii10040 0426

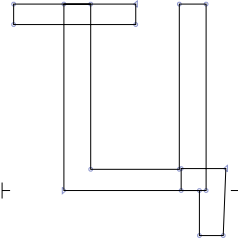

Tetsecyrillic 04B4

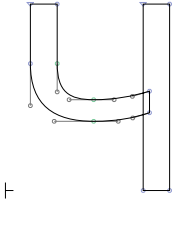

afii10041 0427



Chedescendercyrillic 04B6

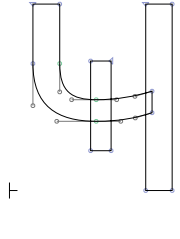

Chevverticalstrokecyrillic 04B8

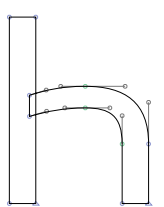

Shhacyrillic 04BA

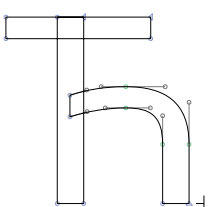

afii10060 040B

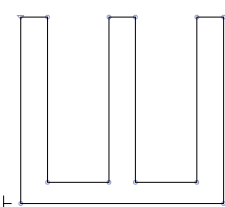

afii10042 0428

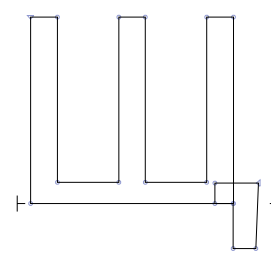

afii10043 0429

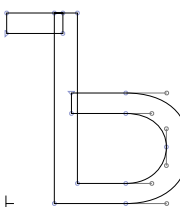

afii10044 042A



uni1F86 1F86



uni1F87 1F87



uni1FB0 1FB0



uni1FB1 1FB1



uni1FB2 1FB2



uni1FB3 1FB3



uni1FB4 1FB4



uni1FB6 1FB6



uni1FB7 1FB7

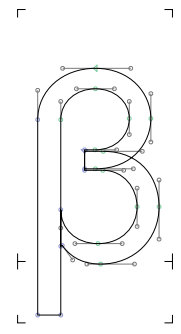

beta 03B2

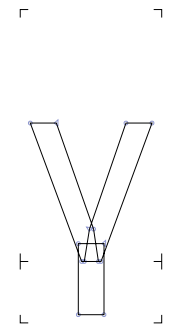

gamma 03B3

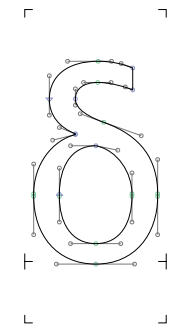

delta 03B4

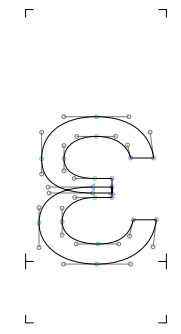

epsilon 03B5



epsilonontonos 03AD

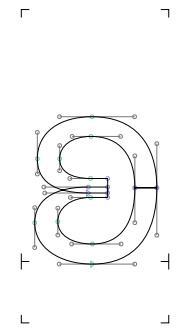

epsilonclosed 029A



epsilon1 025B



epsilon1rev 025C



epsilon1revclosed 025E

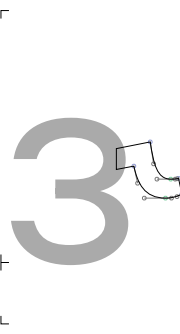

epsilon1revhook 025D



uni1F10 1F10



uni1F11 1F11



uni1F12 1F12



uni1F13 1F13



uni1F14 1F14



uni1F15 1F15



uni1F72 1F72

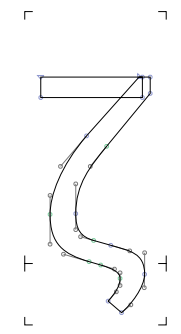

zeta 03B6

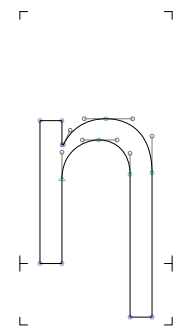

eta 03B7



etatonos 03AE



uni1F20 1F20



uni1F21 1F21



uni1F22 1F22



uni1F23 1F23



uni1F24 1F24



uni1F25 1F25



uni1F26

1F26



uni1F27

1F27



uni1F74

1F74



uni1F90

1F90



uni1F91

1F91



uni1F92

1F92



uni1F93

1F93



uni1F94

1F94



uni1F95

1F95



uni1F96

1F96



uni1F97

1F97



uni1FC2

1FC2



uni1FC3

1FC3



uni1FC4

1FC4



uni1FC6

1FC6



uni1FC7

1FC7

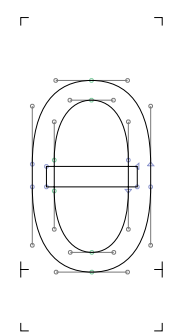

theta

0388

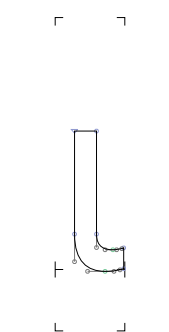

iota

0389

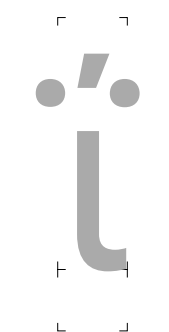

iotadieresis

0390



iotatonos

03AF

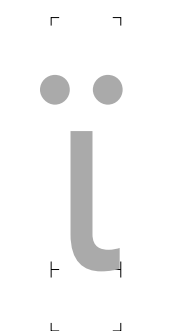

iotadieresis

03CA

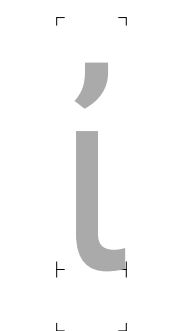

uni1F30

1F30

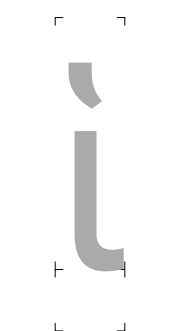

uni1F31

1F31

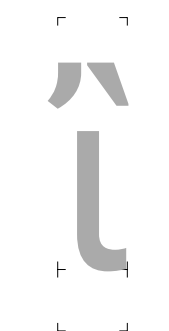

uni1F32

1F32



uni1F33

1F33



uni1F34

1F34



uni1F35

1F35



uni1F36

1F36



uni1F37

1F37



uni1F76

1F76



uni1FD0

1FD0

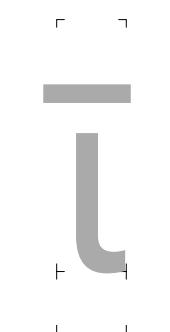

uni1FD1

1FD1

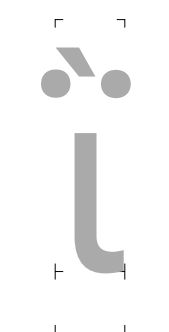

uni1FD2

1FD2

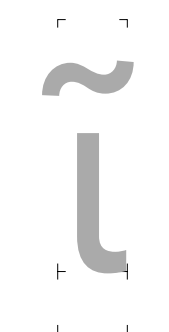

uni1FD6

1FD6



uni1FD7

1FD7

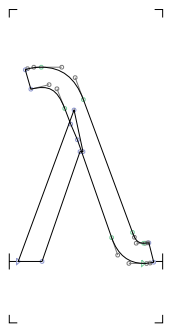

lambda

03BB

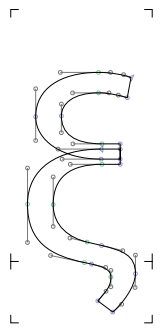

xi

03BE

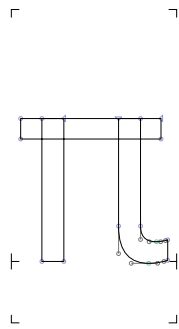

pi

03C0

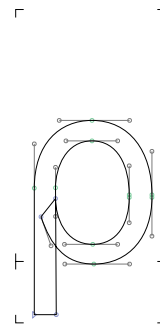

rho

03C1

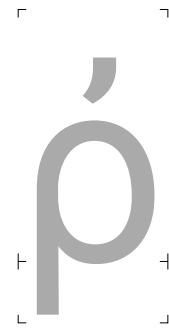

uni1FE4

1FE4

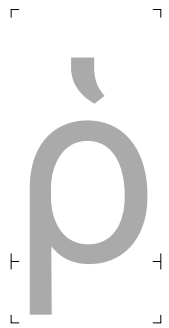

uni1FE5

1FE5



uni03FC

03FC

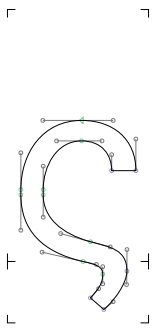

sigma1

03C2

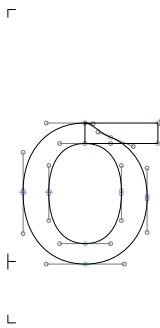

sigma

03C3

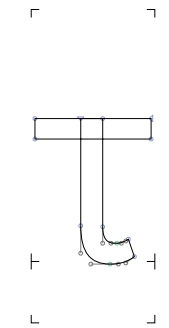

tau

03C4

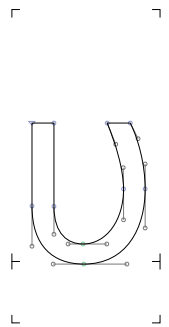

upsilon

03C5



upsilondieresistonos

03B0



upsilondieresis

03CB

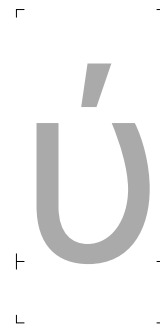

upsilontonos

03CD

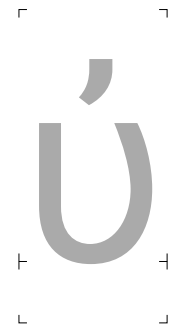

uni1F50

1F50

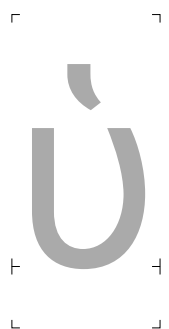

uni1F51

1F51

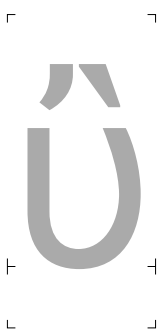

uni1F52

1F52



uni1F53

1F53



uni1F54

1F54



uni1F55

1F55



uni1F56

1F56



uni1F57

1F57

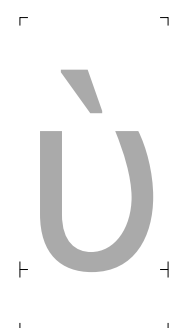

uni1F7A

1F7A



uni1FE0

1FE0

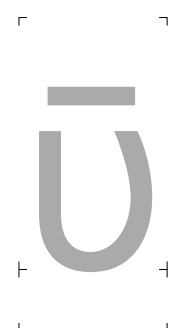

uni1FE1

1FE1

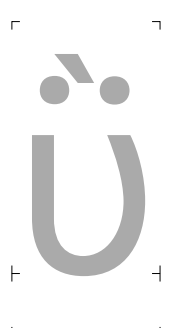

uni1FE2

1FE2



uni1FE6

1FE6



uni1FE7

1FE7

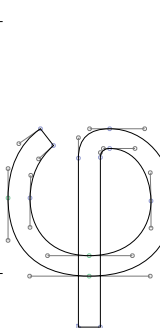

phi

03C6

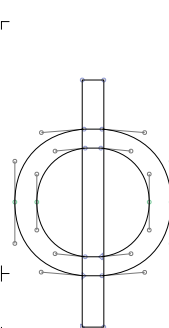

phigreek

03D5

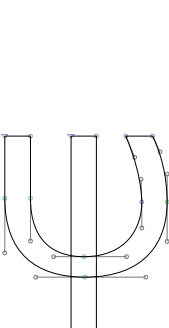

psi

03C8

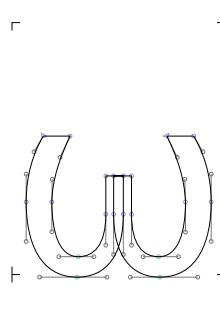

omega

03C9



omegatonos

03CE



uni1F60

1F60



uni1F61

1F61



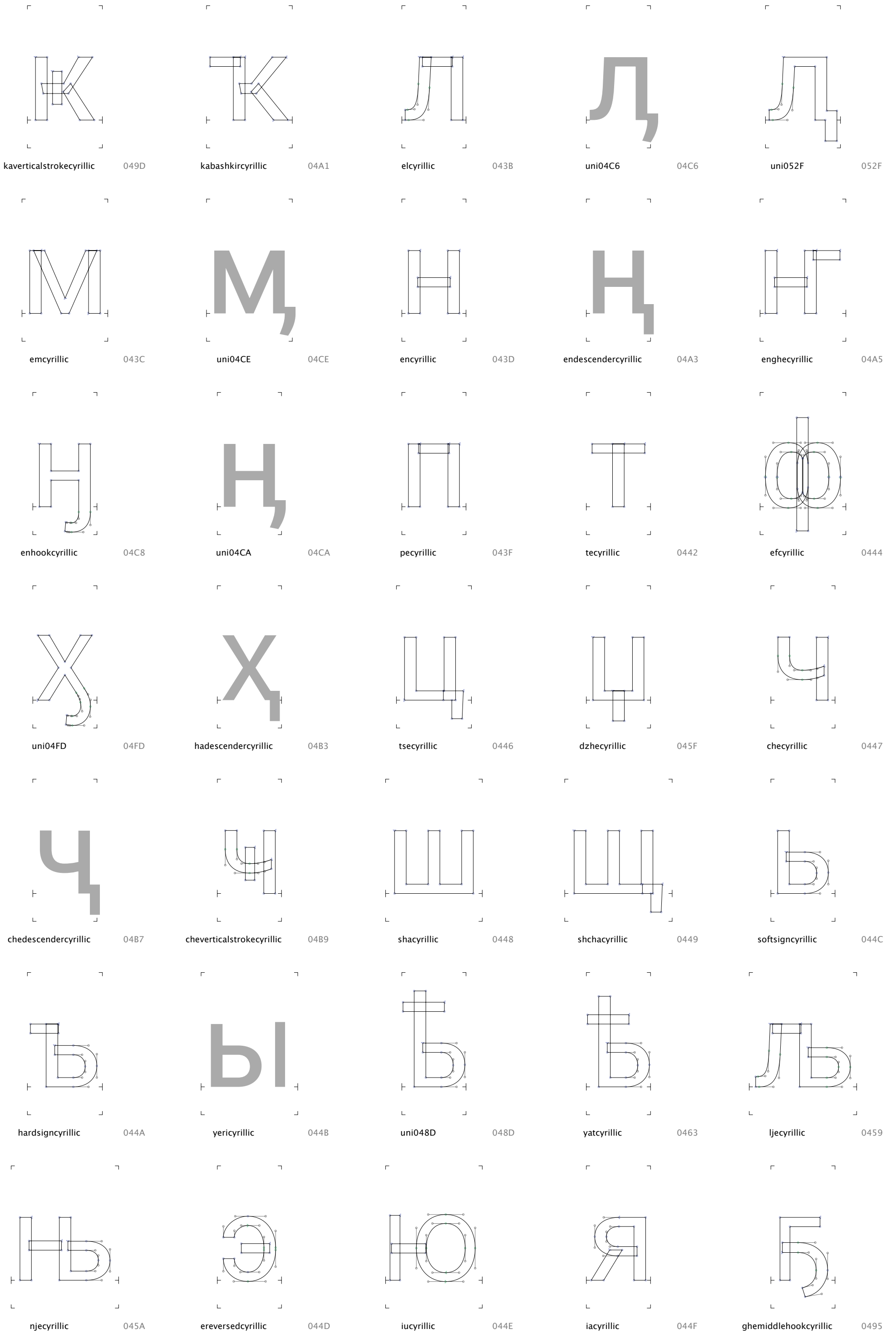

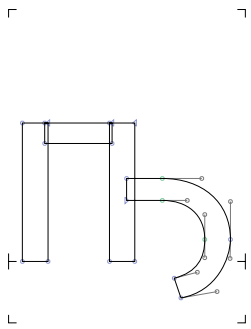

pemiddlehookcyrillic 04A7

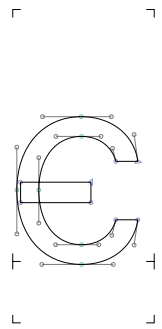

ecyrillic 0454

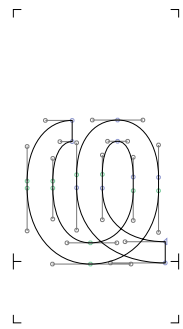

haabkhasiancyrillic 04A9

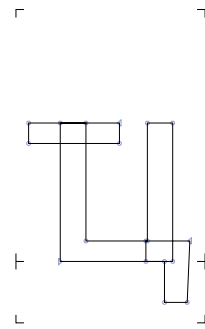

tetsecyrillic 04B5

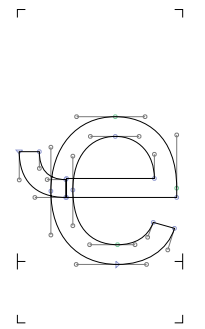

cheabkhasiancyrillic 04BD

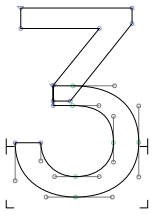

dzeabkhasiancyrillic 04E1

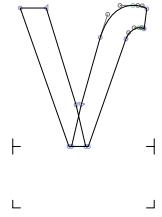

izhitsacyrillic 0475

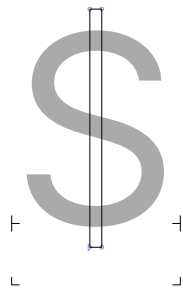

dollar 0024

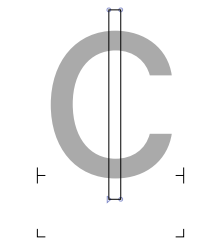

cent 00A2

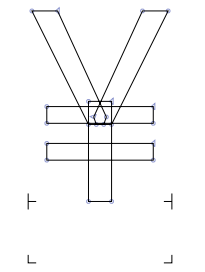

yen 00A5

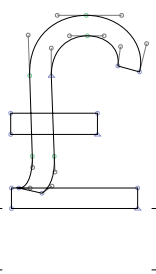

sterling 00A3

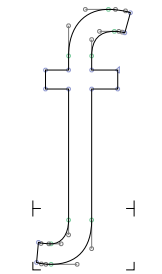

florin 0192

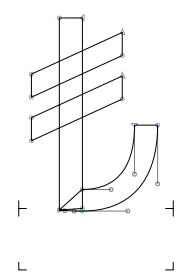

uni20BA 20BA

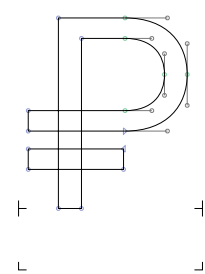

uni20BD 20BD

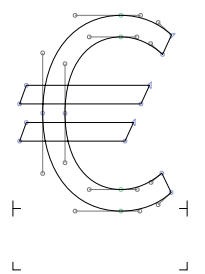

euro 20AC

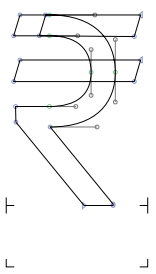

uni20B9 20B9

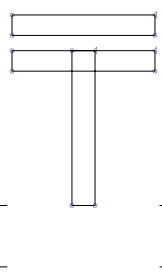

tenge 20B8

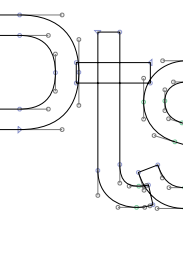

peseta 20A7

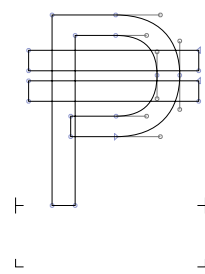

peso 20B1

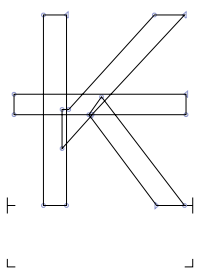

kip 20AD

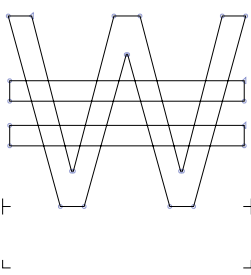

won 20A9

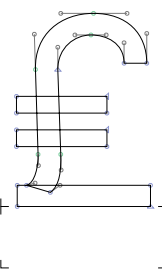

lira 20A4

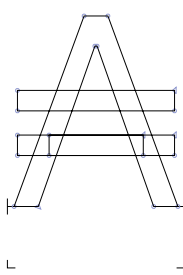

austral 20B3

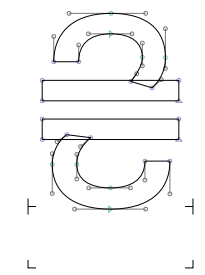

hryvnia 20B4

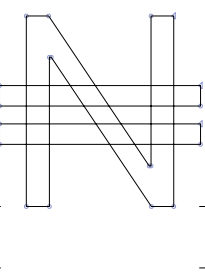

naira 20A6

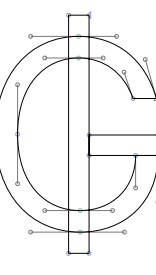

guarani 20B2

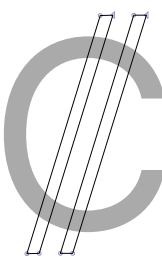

coloncurency 20A1

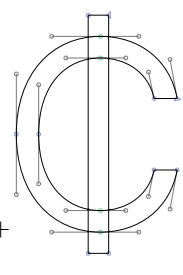

cedi 20B5

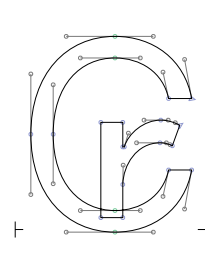

cruzeiro 20A2

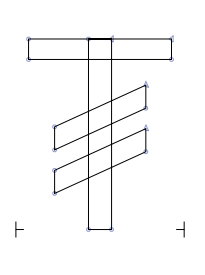

tugrik 20AE

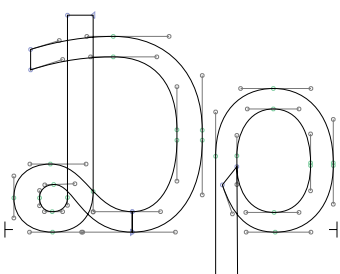

uni20AF 20AF

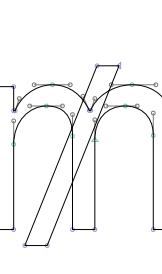

mill 20A5

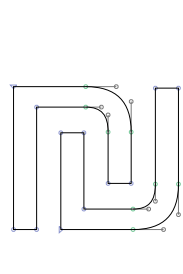

afii57636 20AA

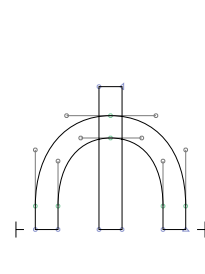

manat 20BC



rupee 20A8

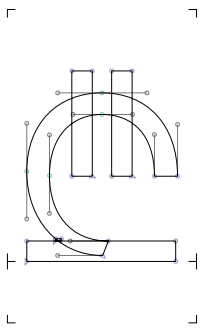

lari 20BE



franc 20A3

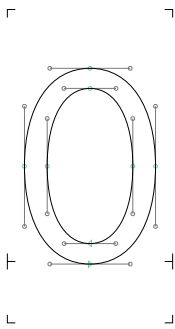

zero 0030

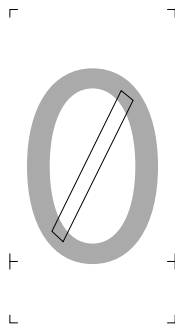

zero.slash

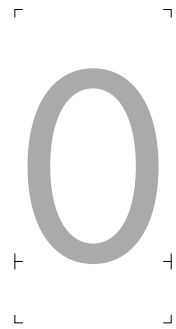

zero.tf

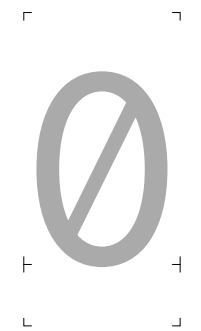

zero.tf.slash

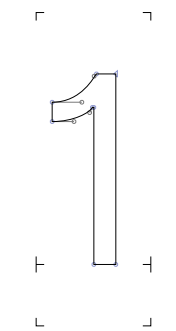

one 0031

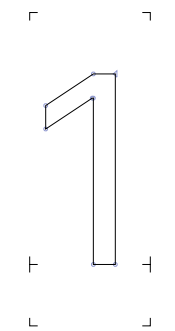

one.ss01

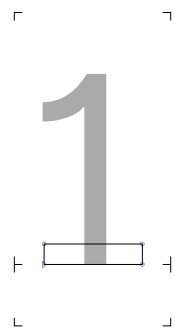

one.tf

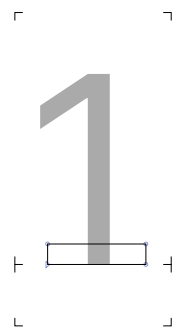

one.tf.ss01

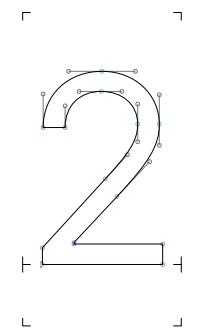

two 0032



two.tf



twostroke 01BB

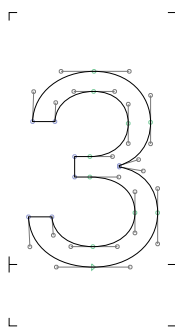

three 0033



three.tf

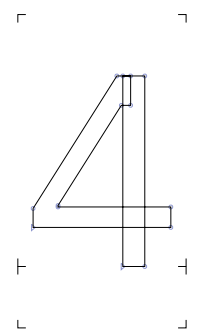

four 0034

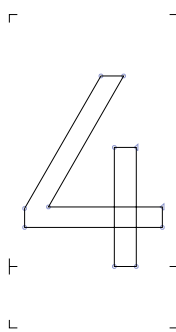

four.ss01



four.tf



four.tf.ss01

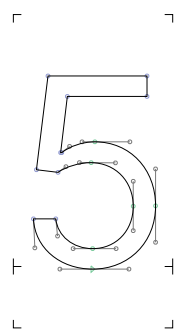

five 0035



five.tf

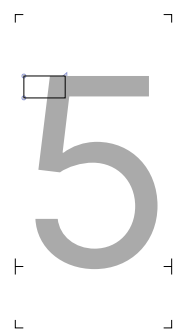

Tonefive 01BC

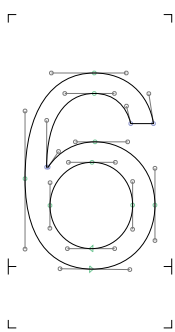

six 0036

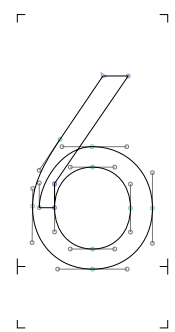

six.ss01



six.tf



six.tf.ss01

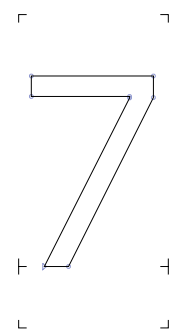

seven 0037



seven.tf

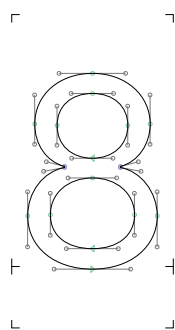

eight 0038



eight.tf

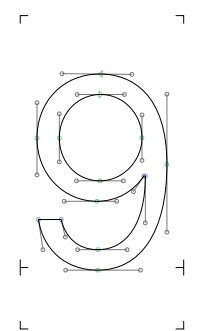

nine 0039

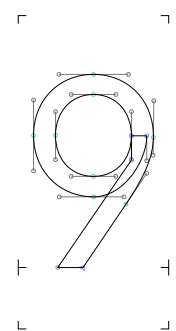

nine.ss01



nine.tf



nine.tf.ss01

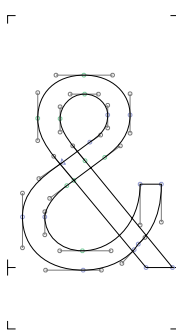

ampersand 0026

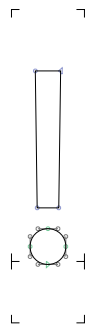

exclam 0021



exclamdbl 203C



exclamdown 00A1

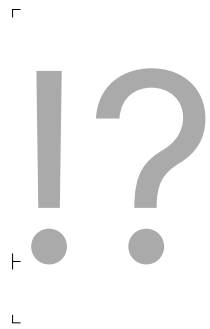

uni2049 2049

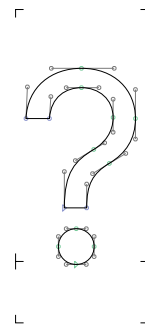

question 003F

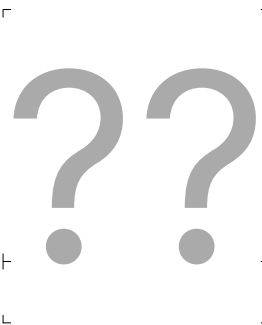

uni2047 2047

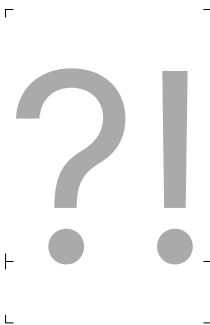

uni2048 2048



questiondown 00BF

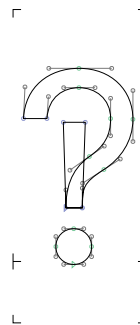

interrobang 203D



invertedinterrobang 2E18

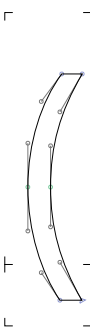

parenleft 0028



parenleft.case



parenright 0029



parenright.case

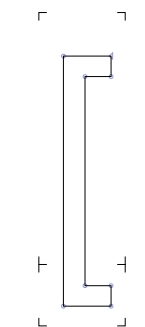

bracketleft 005B



bracketleft.case

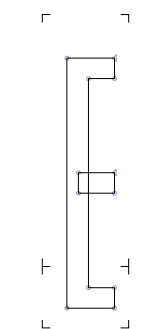

bracketleft_quill 2045

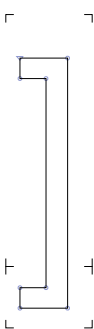

bracketright 005D



bracketright.case

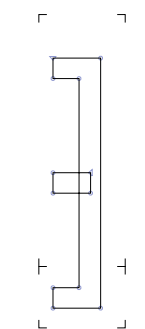

bracketright_quill 2046

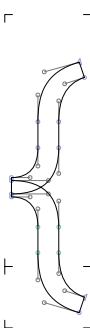

braceleft 007B

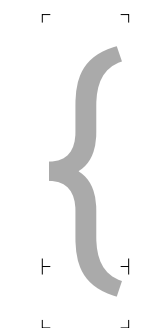

braceleft.case

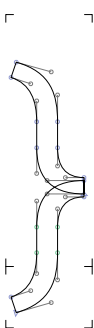

braceright 007D



braceright.case

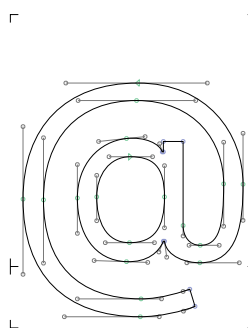

at 0040



at.case

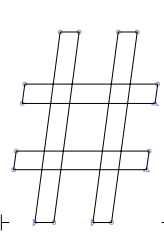

numersign 0023

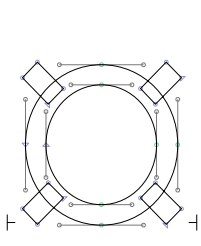

currency 00A4



slash 002F

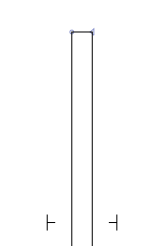

bar 007C

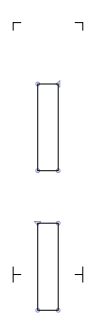

brokenbar 00A6

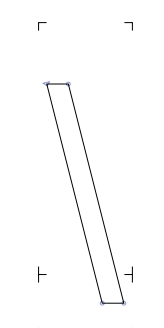

backslash 005C

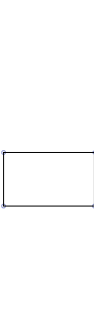



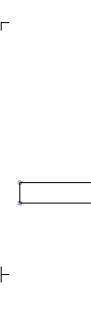







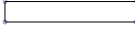

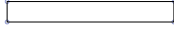











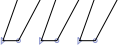









hyphenbullet 2043



hyphen 002D



softhyphen 00AD

				
hyphen.case	endash 2013	endash.case	figuredash 2012	figuredash.case
				
emdash 2014	emdash.case	horizontalbar 2015	bullet 2022	bullet.case
				
openbullet 25E6	openbullet.case	quoteleft 2018	quoteright 2019	apostrophemod 02BC
				
primetripl 2034	quotesingle 0027	minute 2032	quotedbl 0022	second 2033
				
quotedblleft 201C	quotedblright 201D	quotedblbase 201E	quotessinglbase 201A	comma 002C
				
comma.tf	period 002E	period.tf	ellipsis 2026	twodotleader 2025
				
colon 003A	colon.case	colon.tf	semicolon 003B	semicolon.tf

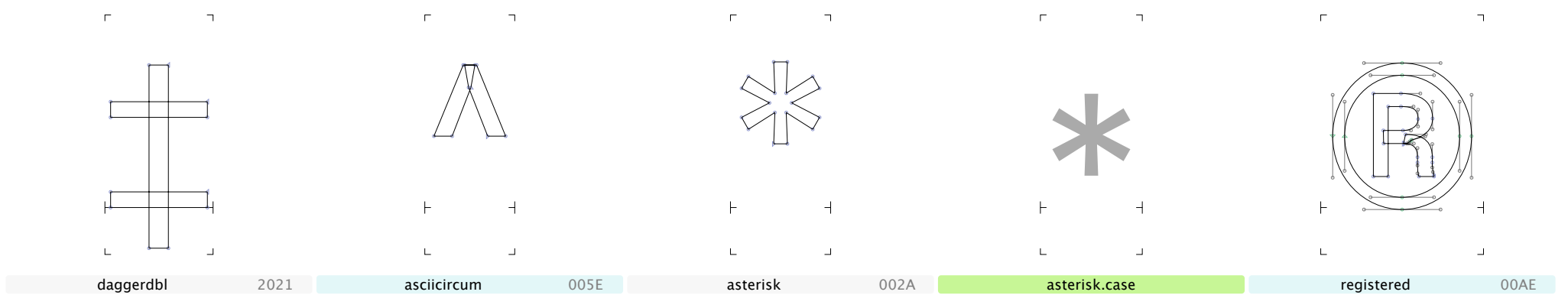
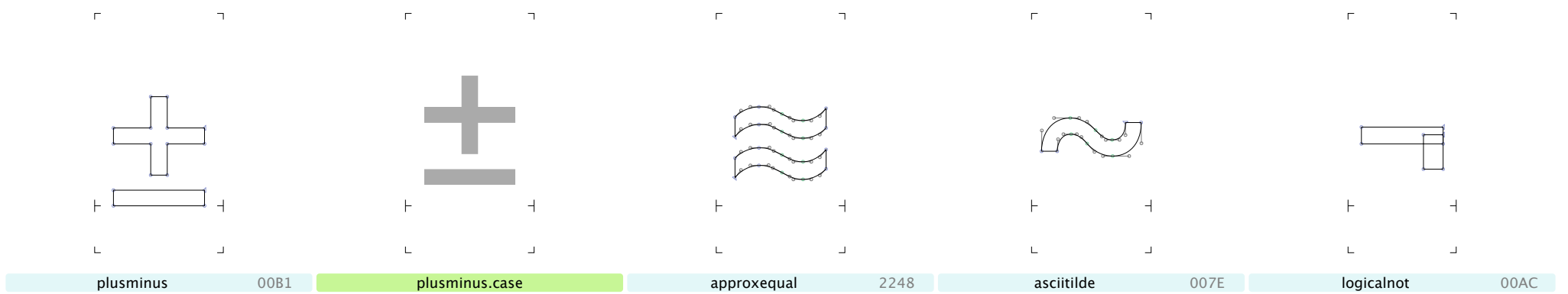
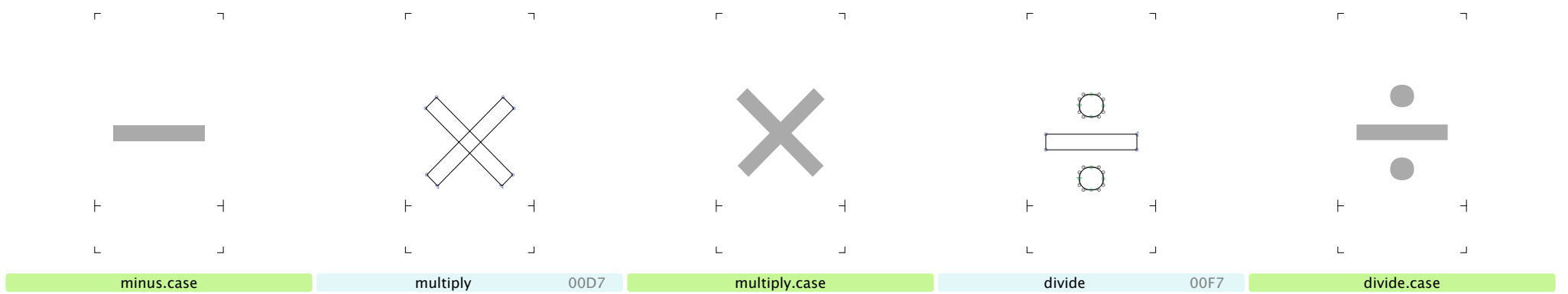
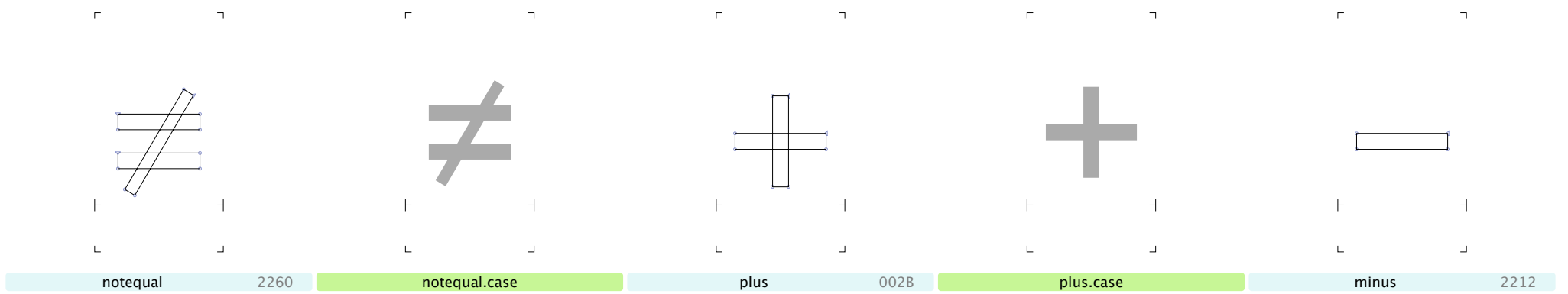
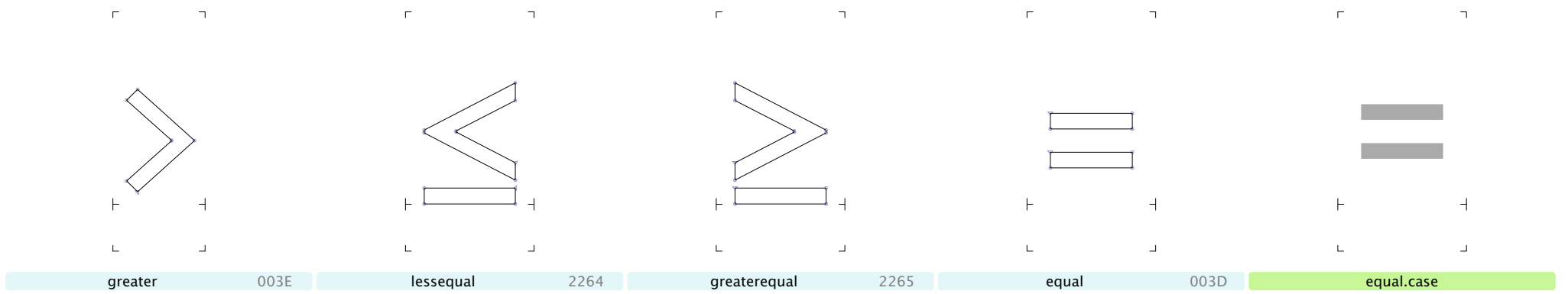

trademark 2122

servicemark 2120

degree 00B0

ordfeminine 00AA

ordmasculine 00BA

i.numr

n.numr

paragraph 00B6

section 00A7

copyright 00A9

infinity 221E

partialdiff 2202

summation 2211

product 220F

integral 222B

radical 221A

emptyset 2205

lozenge 25CA

a.sups 1D43

b.sups 1D47

c.sups 1D9C

d.sups 1D48

e.sups 1D49

f.sups 1DA0

g.sups 1D4D

h.sups 02B0

i.sups 2071

j.sups 02B2

k.sups 1D4F

l.sups 02E1

m.sups 1D50

n.sups 207F

o.sups 1D52

p.sups 1D56

q.sups 146B

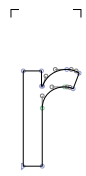

r.sups 02B3

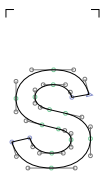

s.sups 02E2

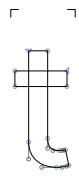

t.sups 1D57

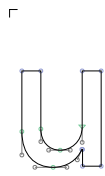

u.sups 1D58

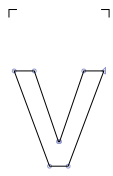

v.sups 1D58



w.sups 02B7

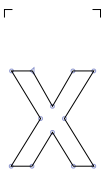

x.sups 02E3



y.sups 02B8

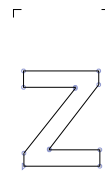

z.sups 1DBB

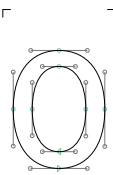

zero.sups 2070

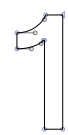

one.sups 00B9

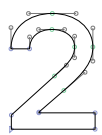

two.sups 00B2

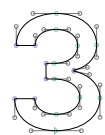

three.sups 00B3

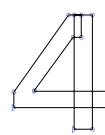

four.sups 2074

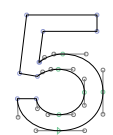

five.sups 2075

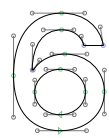

six.sups 2076

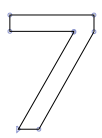

seven.sups 2077

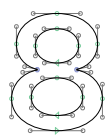

eight.sups 2078

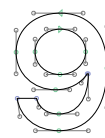

nine.sups 2079



parenleft.sups 207D

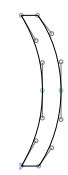

parenright.sups 207E

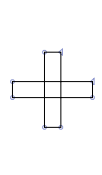

plus.sups 207A

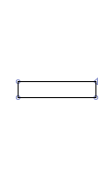

minus.sups 207B

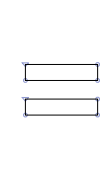

equal.sups 207C



a.sups 2090



b.subs



c.subs



d.subs



e.subs 2091



f.subs



g.subs



h.subs 2095



i.subs 1D62



j.subs 2C7C



k.subs 2096

┌ ┐

┌ ┐

┌ ┐

┌ ┐

┌ ┐

l

m

n

o

p

l.subs 2097

m.subs 2098

n.subs 2099

o.subs 2092

p.subs 209A

┌ ┐

┌ ┐

┌ ┐

┌ ┐

┌ ┐

q

r

s

t

u

q.subs

r.subs 1D63

s.subs 209B

t.subs 209C

u.subs 1D64

┌ ┐

┌ ┐

┌ ┐

┌ ┐

┌ ┐

v

w

x

y

z

v.subs 1D65

w.subs

x.subs 2093

y.subs

z.subs

┌ ┐

┌ ┐

┌ ┐

┌ ┐

┌ ┐

0

1

2

3

4

zero.subs 2080

one.subs 2081

two.subs 2082

three.subs 2083

four.subs 2084

┌ ┐

┌ ┐

┌ ┐

┌ ┐

┌ ┐

5

6

7

8

9

five.subs 2085

six.subs 2086

seven.subs 2087

eight.subs 2088

nine.subs 2089

┌ ┐

┌ ┐

┌ ┐

┌ ┐

┌ ┐

(

)

+

-

=

parenleft.subs 208D

parenright.subs 208E

plus.subs 208A

minus.subs 208B

equal.subs 208C

┌ ┐

┌ ┐

┌ ┐

┌ ┐

┌ ┐

0

1

2

3

4

zero.dnomf

one.dnomf

two.dnomf

three.dnomf

four.dnomf

5

five.dnomf

6

six.dnomf

7

seven.dnomf

8

eight.dnomf

9

nine.dnomf

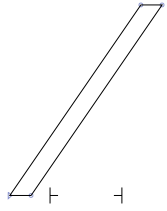

fraction 2044

0

zero.dnom

1

one.dnom

2

two.dnom

3

three.dnom

4

four.dnom

5

five.dnom

6

six.dnom

7

seven.dnom

8

eight.dnom

9

nine.dnom

+

plus.dnom

-

minus.dnom

=

equal.dnom

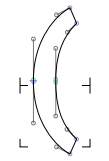

parenleft.dnom

0

zero.numr

1

one.numr

2

two.numr

3

three.numr

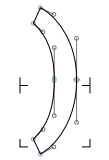

parenright.dnom

4

four.numr

5

five.numr

6

six.numr

7

seven.numr

8

eight.numr

9

nine.numr

+

plus.numr

-

minus.numr

=

equal.numr

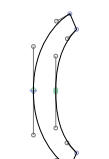

parenleft.numr

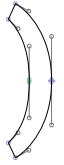

parenright.numr

0

zero.frac

1

one.frac

2

two.frac

3

three.frac

4

four.frac

5

five.frac

6

six.frac

7

seven.frac

8

eight.frac

9

nine.frac

1/2

onehalf

00BD

1/4

onequarter

00BC

3/4

threequarters

00BE

5/6

fivesixths

215A

1/

onefraction

215F

7/8

seveneighths

215E

1/8

oneeighth

215B

5/8

fiveeighths

215D

3/8

threeeighths

215C

0/0

percent

0025

0/00

perthousand

2030

0/000

pertenthousand

2031

A/S

uni214D

214D

C/U

cadauna

2106

C/O

careof

2105

a/C

accountof

2100

a/S

addresssubject

2101

No

numero

2116

◌́

acute

0084

◌̃

hungarumlaut

02DD

◌̀

grave

0060

◌̄

tonos

0384











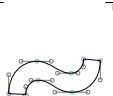

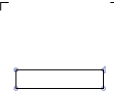
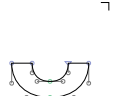



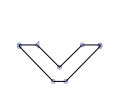
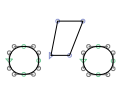

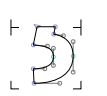

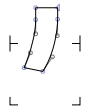

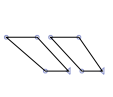
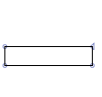

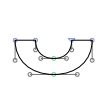
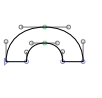
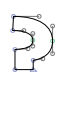
◌̈





dieresis



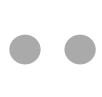

00A8





◌̈́





casedieresis.cn



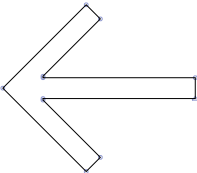

				
circumflex 02C6	tilde 02DC	casetilde.cn	macron 00AF	breve 02D8
				
cyrillicbreve	dotaccent 02D9	ring 02DA	caron 02C7	dieresisnos 0385
				
				
cedilla 00B8	ogonek 02DB	commaaccent F6C3	acutecomb 0301	acutedblnosp 030B
				
gravecomb 0300	dblgravecmb 030F	macroncomb 0304	dieresisnosp 0308	brevensp 0306
				
breveinvnosp 0311	hook 0309	circumflexnosp 0302	caroncmb 030C	tildecomb 0303
				
dotnosp 0307	ringnosp 030A	hornnosp 031B	ogoneknosp 0328	cedillanosp 0327
				
circumflexsubnosp 032D	brevesubnosp 032E	dotbelow 0323	commabelowcmb 0326	dotdblsubnosp 0324

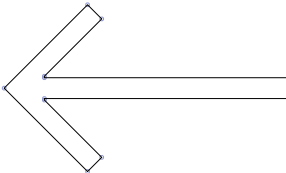

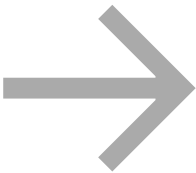

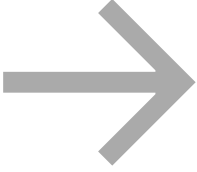
				
ringsubnosp 0325	underscorenosp 0332	tildesubnosp 0330	enquad 2000	emquad 2001

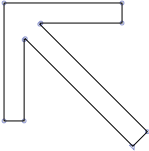
				
enspace 2002	emsp 2003	thirdemsp 2004	quarteremsp 2005	sixthemsp 2006





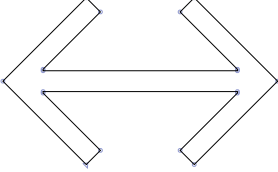

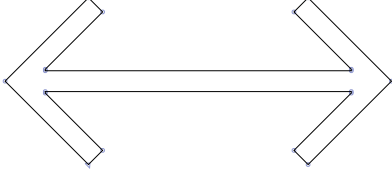

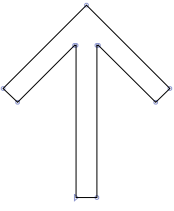
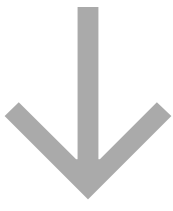
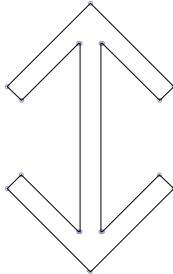
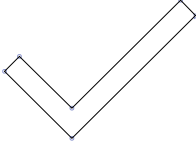

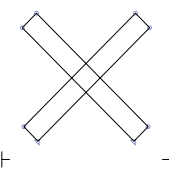
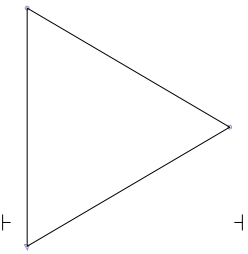
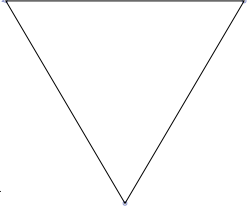
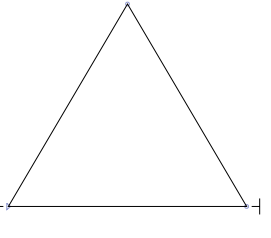
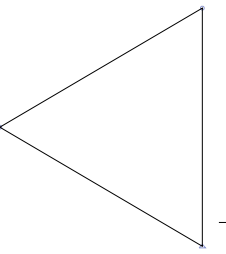
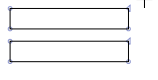

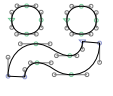
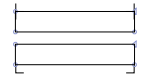

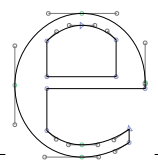





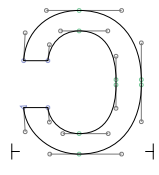
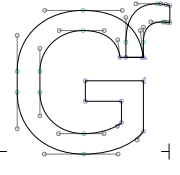

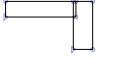
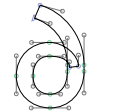
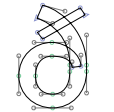
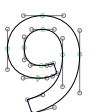
				
figurespace 2007	punctuationspace 2008	thinspace 2009	hairspace 200A	zerowidthspace 200B

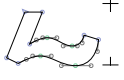
				
leftArrow 2190	leftArrow.case	leftLongArrow 27F5	leftLongArrow.case	rightArrow 2192

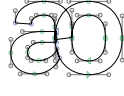
				
rightArrow.case	rightLongArrow 27F6	rightLongArrow.case	northWestArrow 2196	northEastArrow 2197

				
southEastArrow 2198	southWestArrow 2199	leftRightArrow 2194	leftRightArrow.case	leftRightLongArrow 27F7

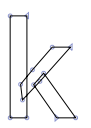
				
leftRightLongArrow.case	upArrow 2191	downArrow 2193	upDownArrow 2195	dngb_check 2713

				
dngb_ballotx 2717	triagrt 25BA	triagdn 25BC	triagup 25B2	blackleftpointingtriangle 25C0
				
uni2009.fra	overscoredblnoisp 033F	crossbar	acutedotcomb.lc	tildedieresiscomb.lc
				
underscoredbl 2017	romanone 2160	estimated 212E	degreecentigrade 2103	dieresisacutecomb.lc
				
carondotcomb.lc	uni1FFD 1FFD	uni1FFE 1FFE	oopen 0254	Gsmallcaphook 029B
				
uni0346 0346	anglesupnoisp 031A	uni1DD8 1DD8	uni1DD9 1DD9	uni1DD2 1DD2
				
uni1DD3 1DD3	uni1DD0 1DD0	uni1DD1 1DD1	uni1DD4 1DD4	uni1DD5 1DD5
				
breveinvsubnoisp 032F	commaturnsupnoisp 0312	uni1DDB 1DDB	uni1DDC 1DDC	ringrighthalfsubnoisp 0339

uni1DDF 1DDF	uni1DDD 1DDD	uni1DDE 1DDE	romanten 2169	degreefarenheit 2109
degreekelvin 212A	uni02AB 02AB	uni02AC 02AC	uni1FCD 1FCD	kappa1 03F0
uni214F 214F	OESmallcap 0276	tackupsubnosp 031D	uni2DFF 2DFF	glottalstopbarinv 01BE
seagullsubnosp 033C	uni02EC 02EC	afi300 200F	caronnosp	romanfour 2163
uni03F5 03F5	uni03F6 03F6	longs 017F	trianglebullet 2023	Ysmallcap 028F
uni03FB 03FB	uni03FD 03FD	uni03FE 03FE	uni03FF 03FF	uni0373 0373
uni0372 0372	uni0371 0371	uni0370 0370	uni0377 0377	gravesubnosp 0316

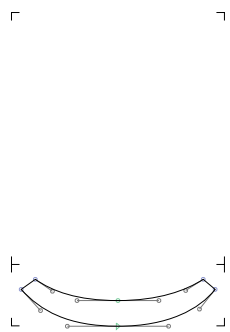

undertie 203F



barmidshortnosp 0335

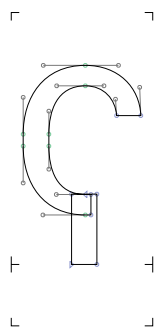

glottalstoprevinv 0295

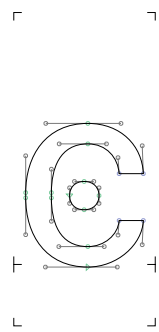

uni037C 037C

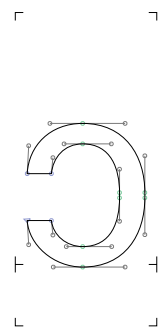

uni037B 037B

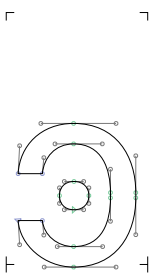

uni037D 037D

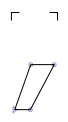

primemod 02B9



uni213B 213B

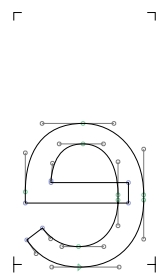

erev 0258

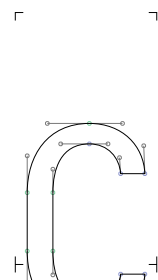

cstretch 0297



Btopbar 0182

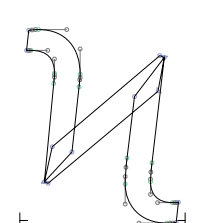

Koppa 03DE



commturnedmod 02BB



commreversedmod 02BD



ringhalfleft 02BF

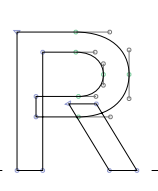

Rsmallcap 0280

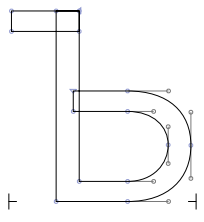

Tonesix 0184

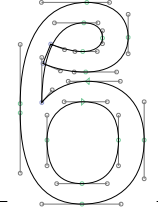

beta1 03D0



uni204F 204F

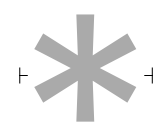

uni204E 204E

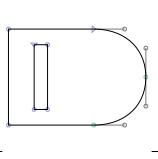

uni204D 204D

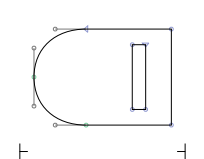

uni204C 204C

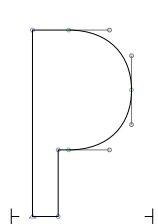

uni204B 204B

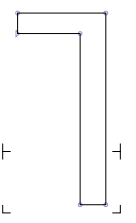

uni204A 204A

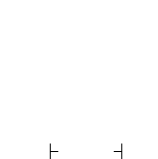

CR

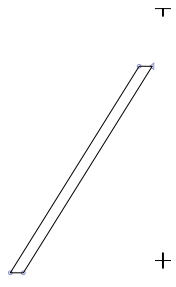

slashlongnosp 0338

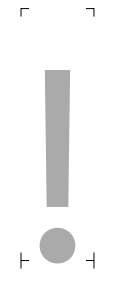

exclam1 01C3

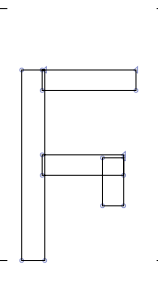

Digamma 03DC

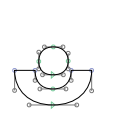

candrbindunosp 0310

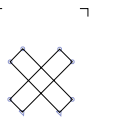

qofdagesh 02DF

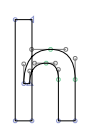

uni036A 036A

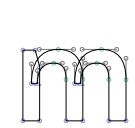

uni036B 036B



uni036C 036C

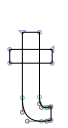

uni036D 036D



uni036E 036E

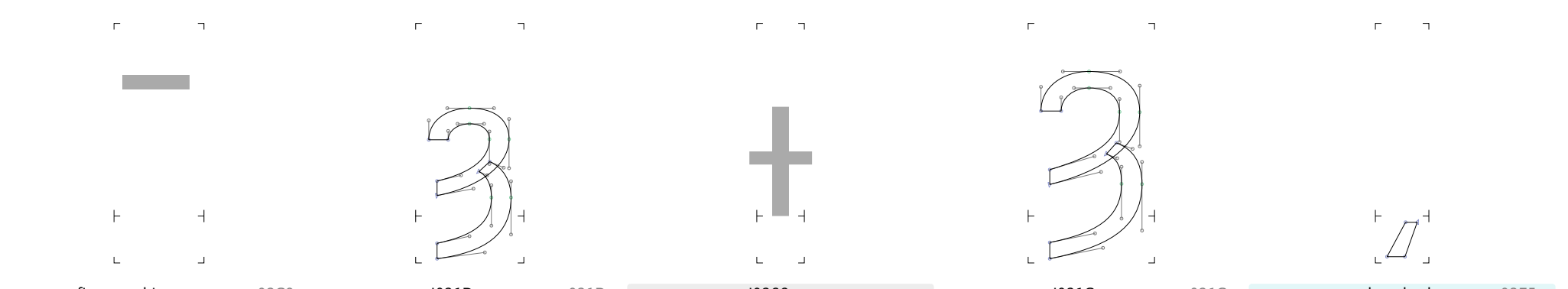
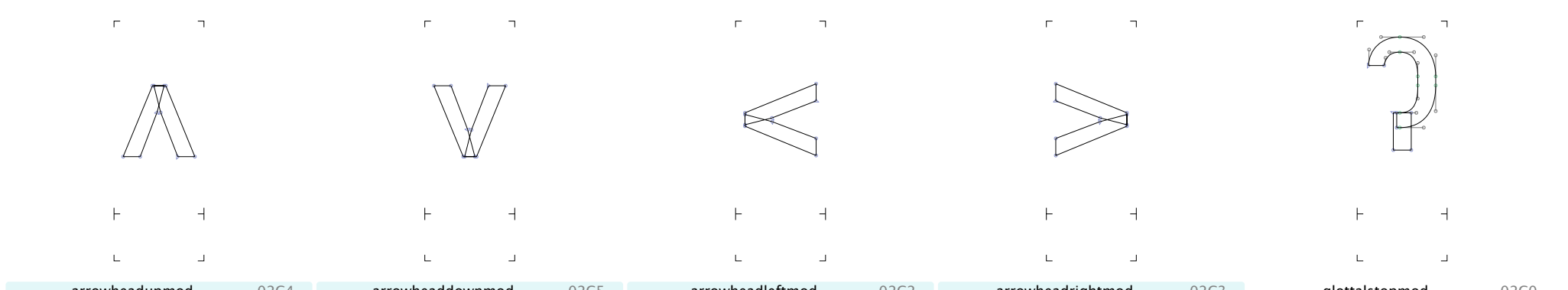
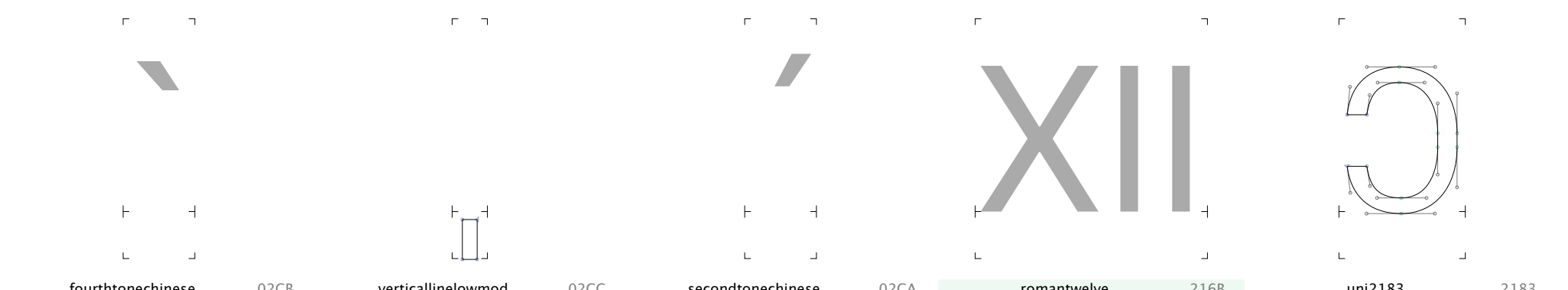
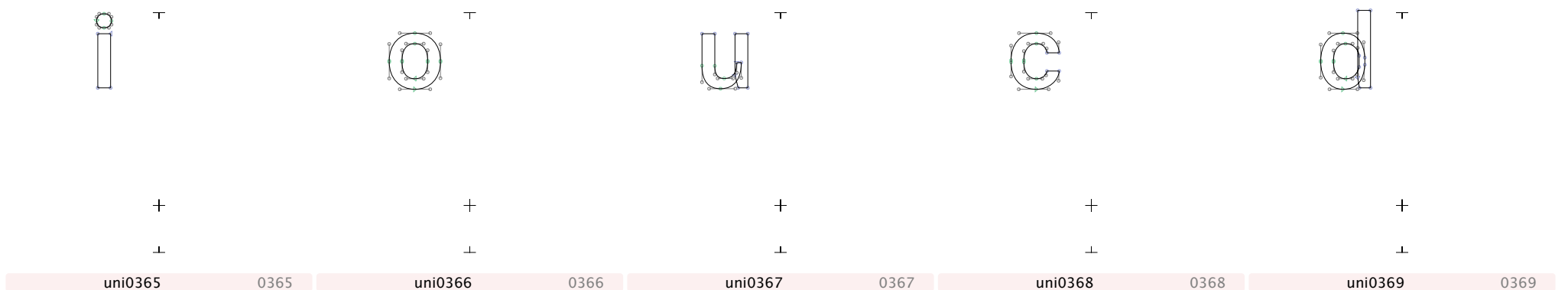
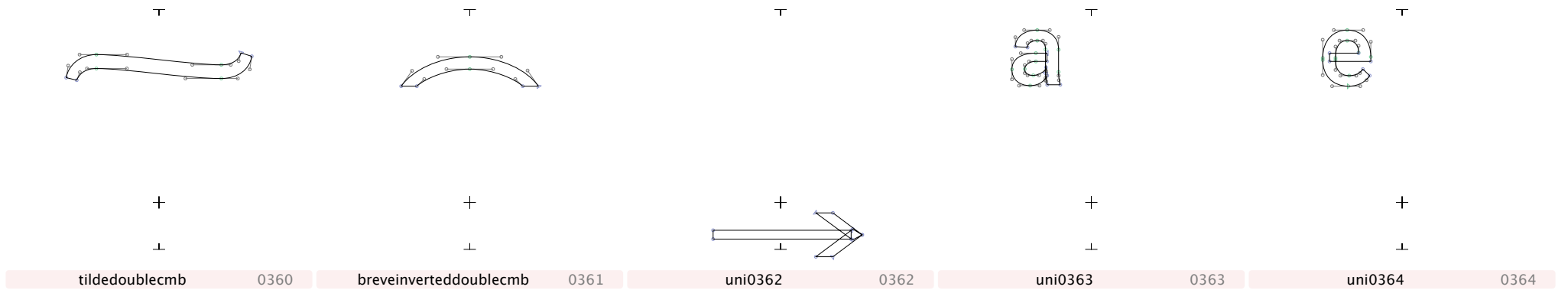
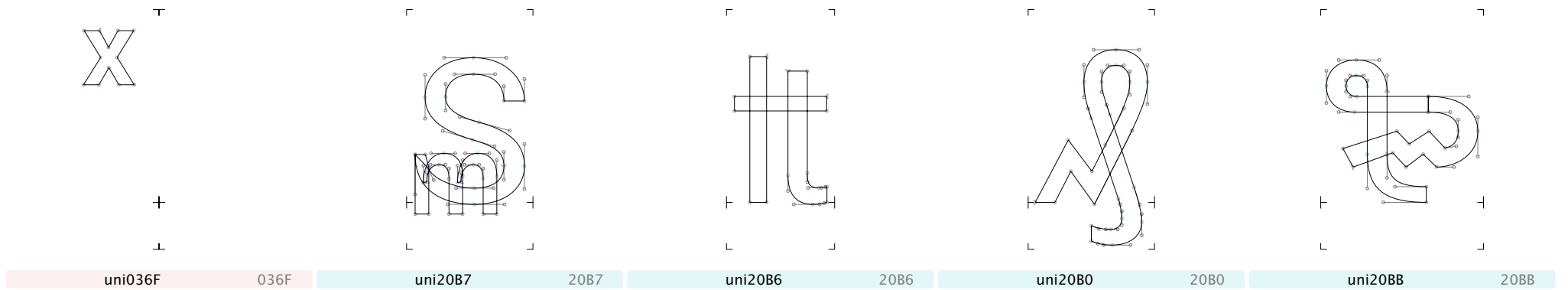



caronsubnosp

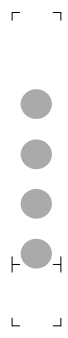

uni205E

205E



uni205A

205A

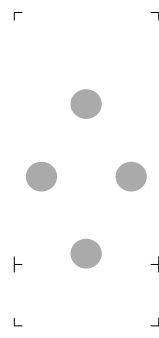

uni205B

205B

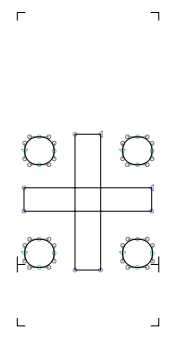

uni205C

205C

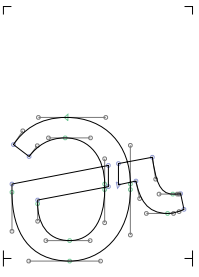

schwahook

025A

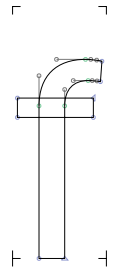

uni1E9D

1E9D



uni1E9F

1E9F

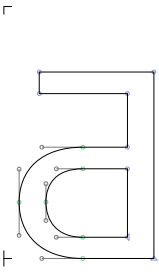

Dtopbar

018B

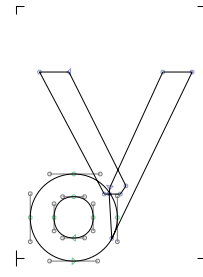

uni1EFE

1EFE

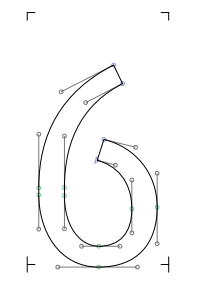

uni1EFD

1EFD

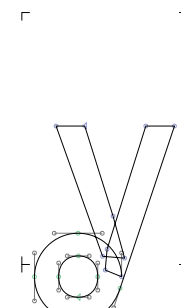

uni1EFF

1EFF

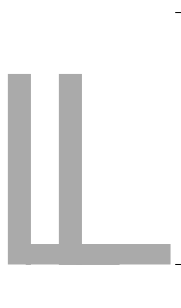

uni1EFA

1EFA

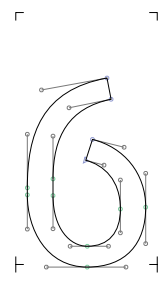

uni1EFC

1EFC

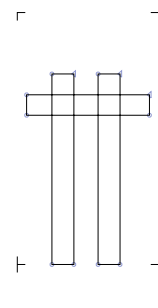

uni1EFB

1EFB

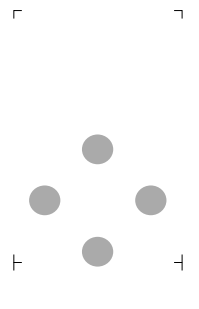

uni2058

2058

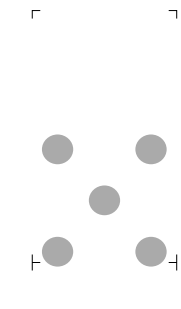

uni2059

2059

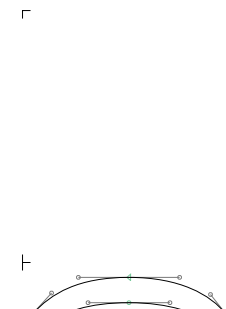

uni2054

2054

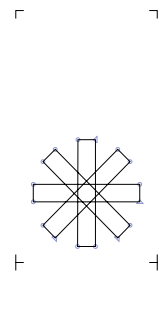

uni2055

2055

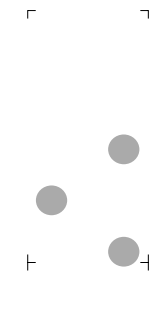

uni2056

2056

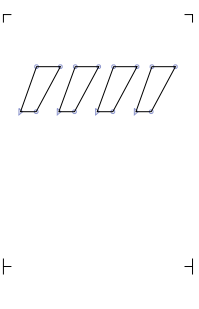

uni2057

2057

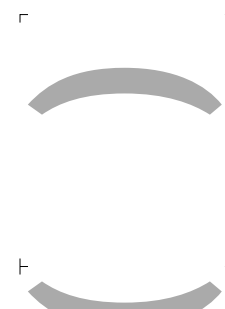

uni2050

2050

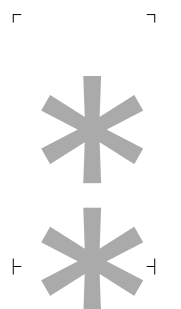

uni2051

2051

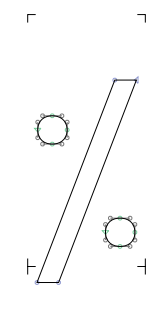

uni2052

2052

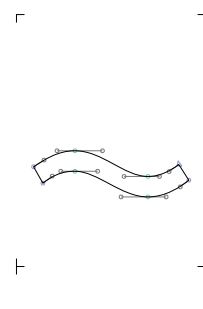

uni2053

2053



ascript_uni02DE

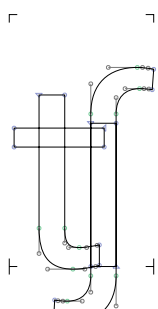

tesh

02A7

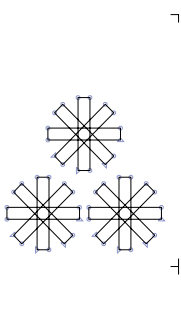

asterism

2042

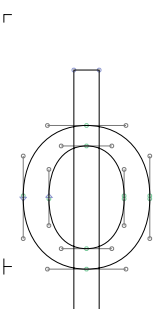

philatin

0278



sixroman

2175



cyrillichookleft

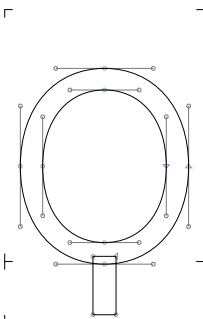

uni03D8

03D8

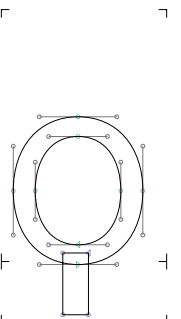

uni03D9

03D9

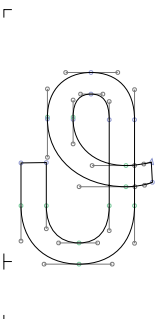

thetasymbolgreek

03D1

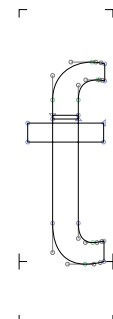

thook

01AD

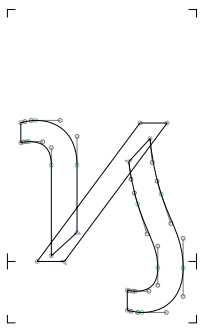

uni03D7

03D7



uni27EF

27EF

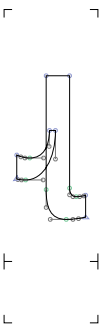

finaltsadi

02B5

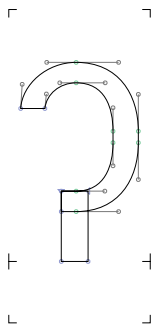

glottalstop

0294



uni0359

0359



uni0358

0358



uni0355

0355



uni0354

0354



uni0357

0357



uni0356

0356



uni0351

0351

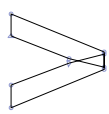

uni0350

0350



uni0353

0353

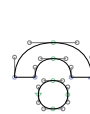

uni0352

0352

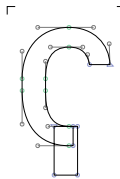

glottalstopreversedmod

02C1

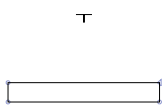

uni035E

035E

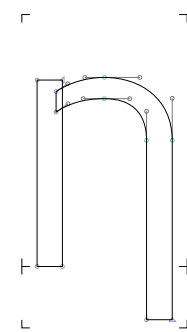

uni0220

0220

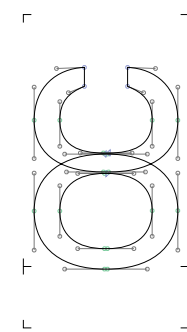

uni0223

0223

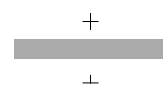

uni035F

035F

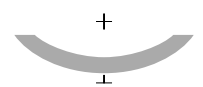

uni035C

035C



uni035B

035B

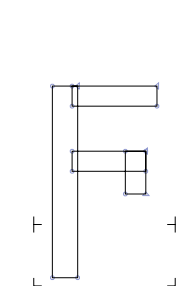

digamma

03DD

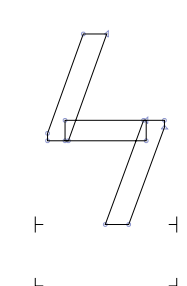

koppa

03DF



ringhalfrightcentered

02D2



colontriangularhalfmod

02D1



colontriangularmod

02D0



minusmod

02D7



plusmod

02D6



downtackmod

02D5



linevertnosp

030D

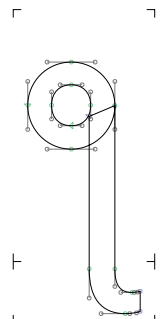

eshlooprev

01AA

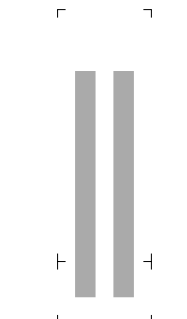

verticalbardbl

2016

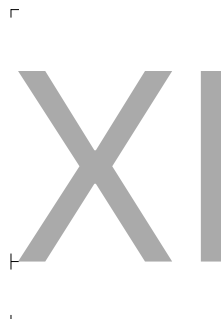

romaneleven

216A

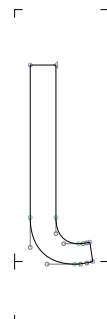

lota1

0196

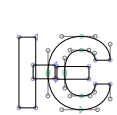

uniA69F

A69F

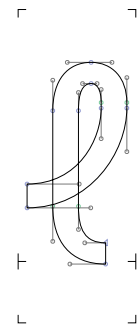

lsquare

2113

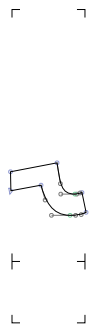

rhotichookmod

02DE



uni1DD6

1DD6

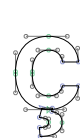

uni1DD7

1DD7



linevertsubnosp

0329

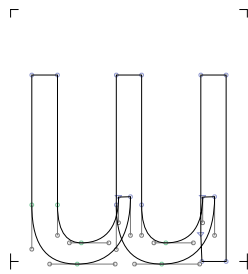

mcapturen

019C



uni205D

205D



spaceopenbox

2423

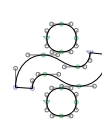

uni034B

034B

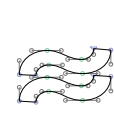

uni034C

034C

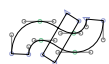

uni034A

034A



uni034F

034F



uni034D

034D



uni034E

034E



uni0348

0348

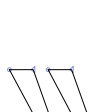

uni0349

0349

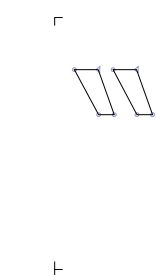

reverseddblprime

2036



perispomenigreekcmb

0342



koroniscmb

0343



uni0347

0347

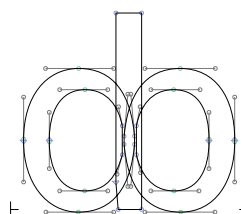

uni0238

0238

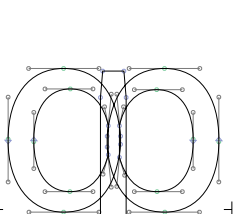

uni0239

0239

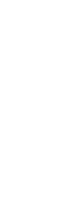

tackdownsubnosp

031E

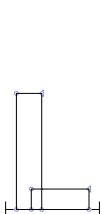

uni02EA

02EA

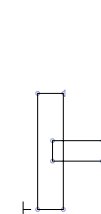

uni02EB

02EB

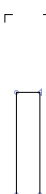

uni2071.ccmp

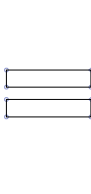

uni02ED

02ED



uni02EF

02EF

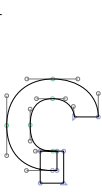

glottalstopreversed.numr

02E4

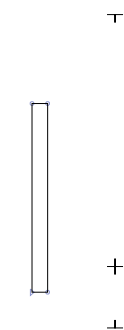

afii61664

200C

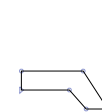

uni1DC6

1DC6

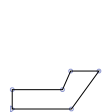

uni1DC4

1DC4

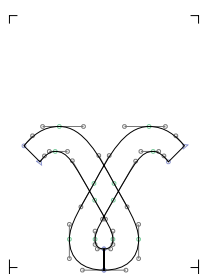

babygamma

0264

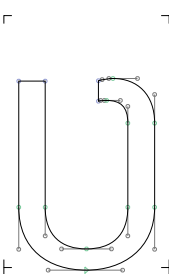

Vcursive

01B2

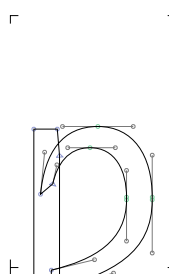

wynn

01BF

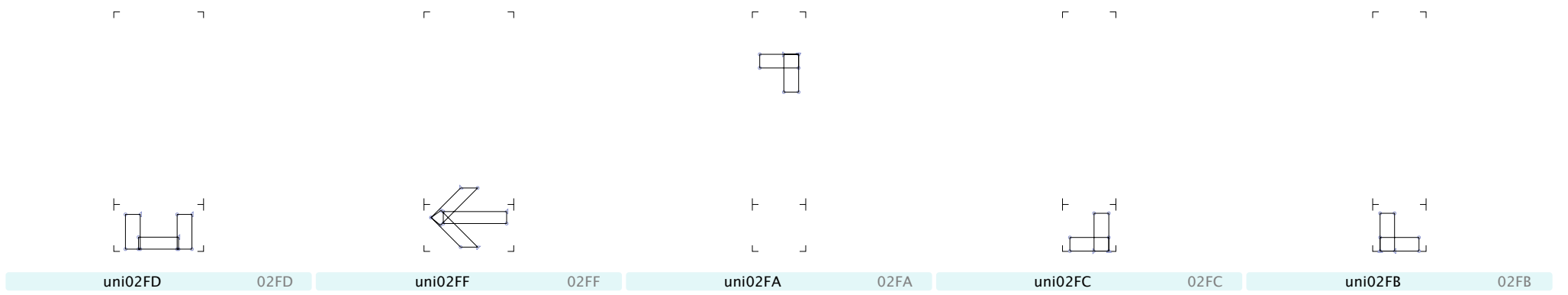
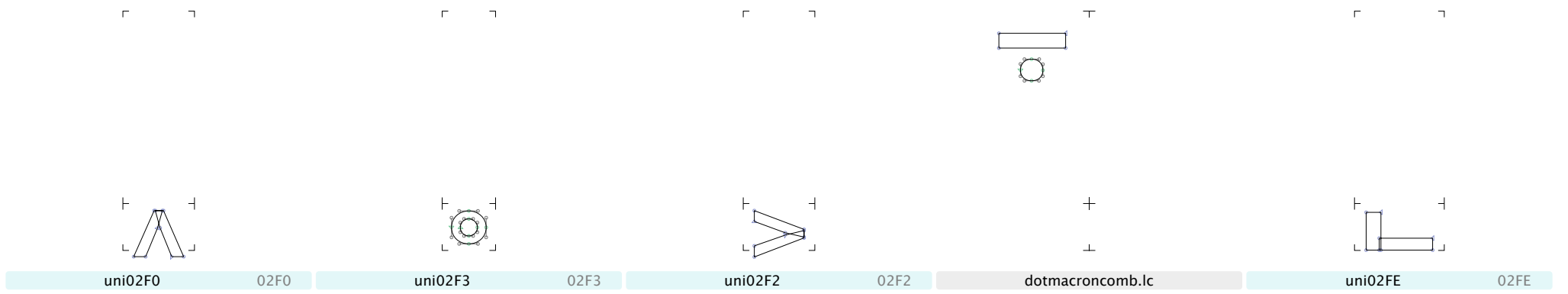
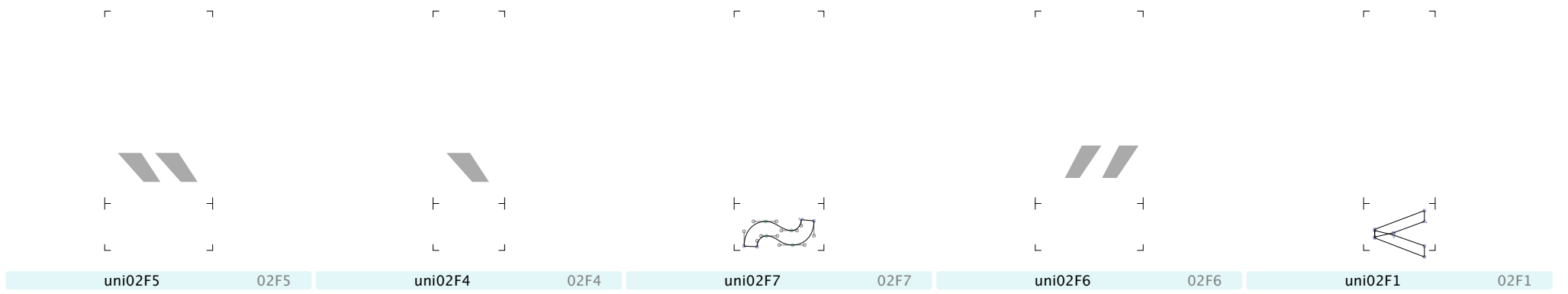
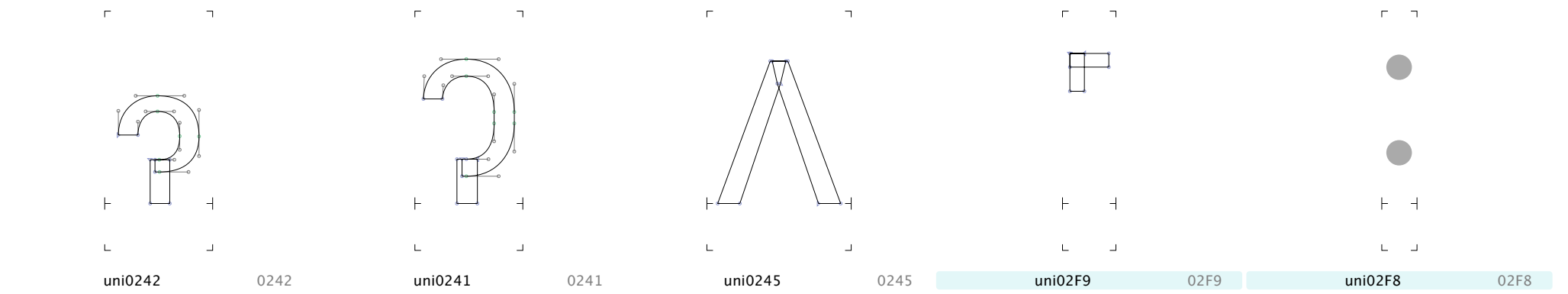
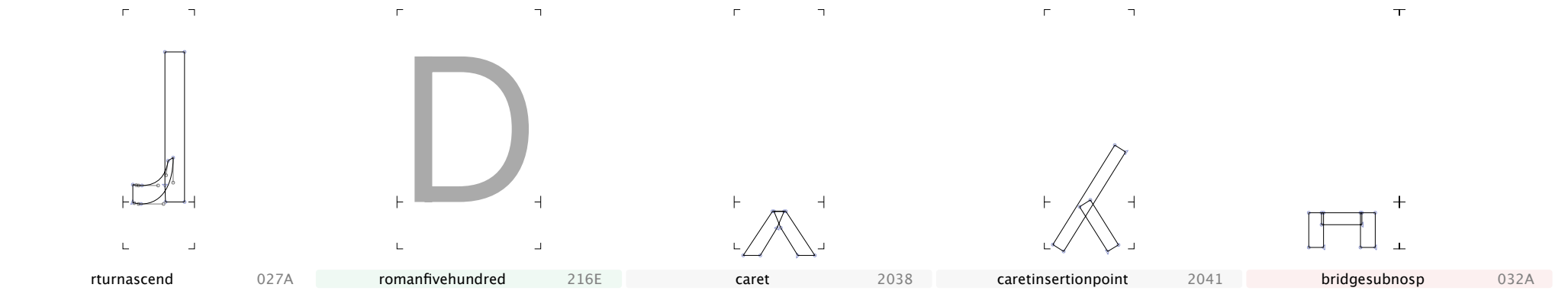
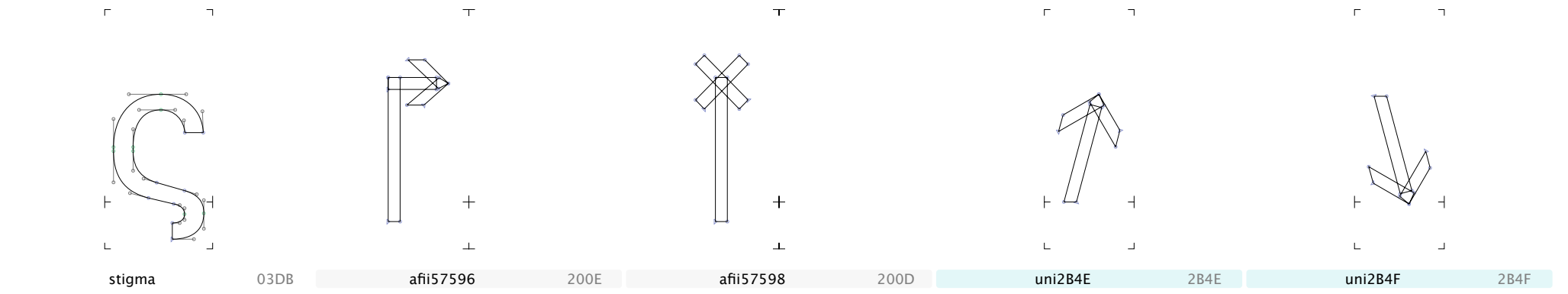
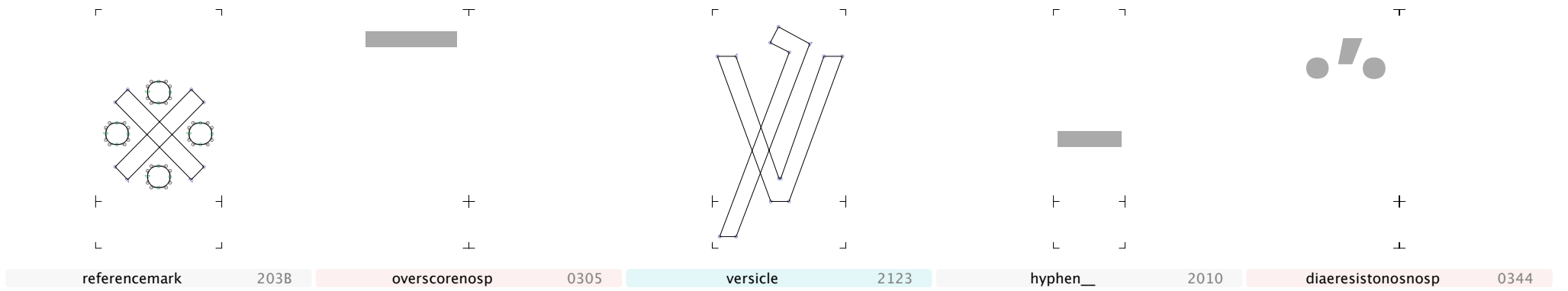

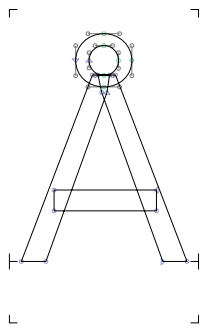

angstrom

212B

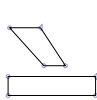

macrongravecomb.ic



macronsubnosp

0331



ringlefthalfsubnosp

031C

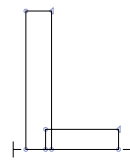

Lsmallcap

029F



squaresubnosp

033B

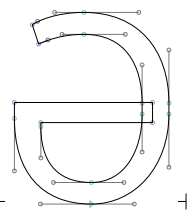

Schwa

018F

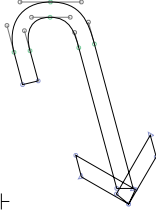

uni2B5B

2B5B

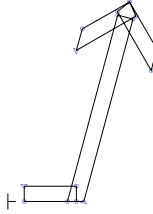

uni2B5C

2B5C

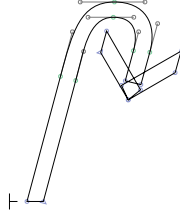

uni2B5A

2B5A

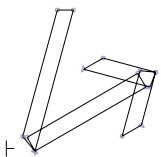

uni2B5F

2B5F

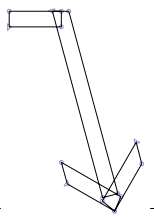

uni2B5D

2B5D

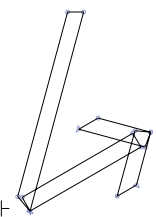

uni2B5E

2B5E

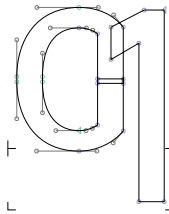

oi

01A3

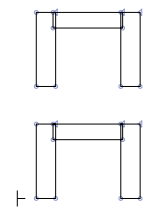

finalmem

02AD

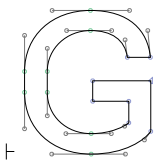

Gsmallcap

0262



Esh

01A9



dieresismacroncomb.ic

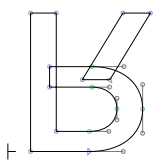

Rsmallcapinv

0281

zerowidthjoiner FEFF

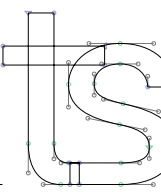

ts

02A6

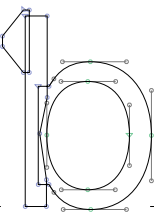

tonesix

0185

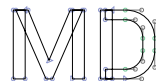

uni1F16B

1F16B

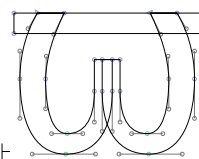

pisymbolgreek

03D6

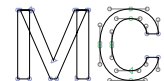

uni1F16A

1F16A

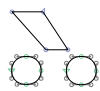

dieresisgravecomb.ic

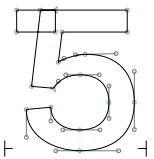

tonefive

018D

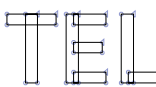

tel

2121



commasuprevnosp

0314

hyphennobreak

2011

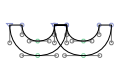

archdblsubnosp

032B

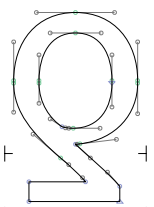

deltaturn

018D

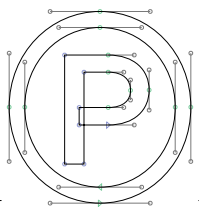

published

2117



macronacutecomb.ic

onedotleader

2024

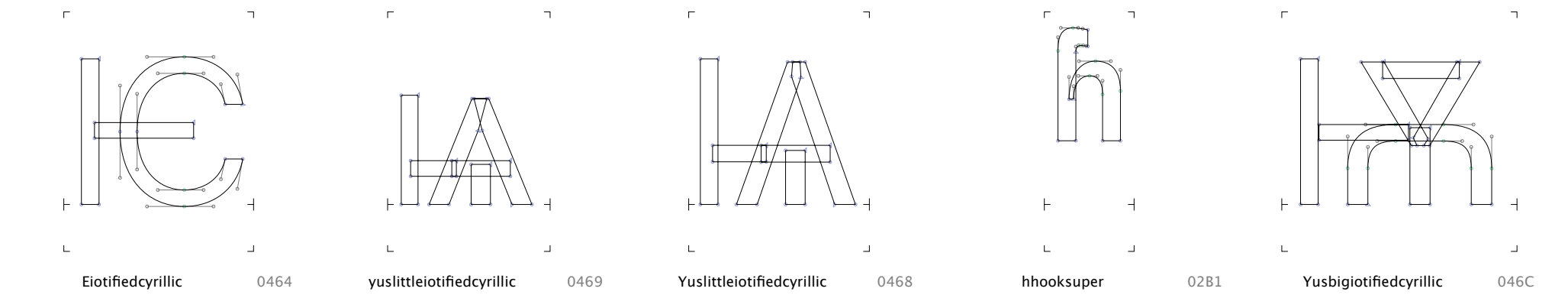
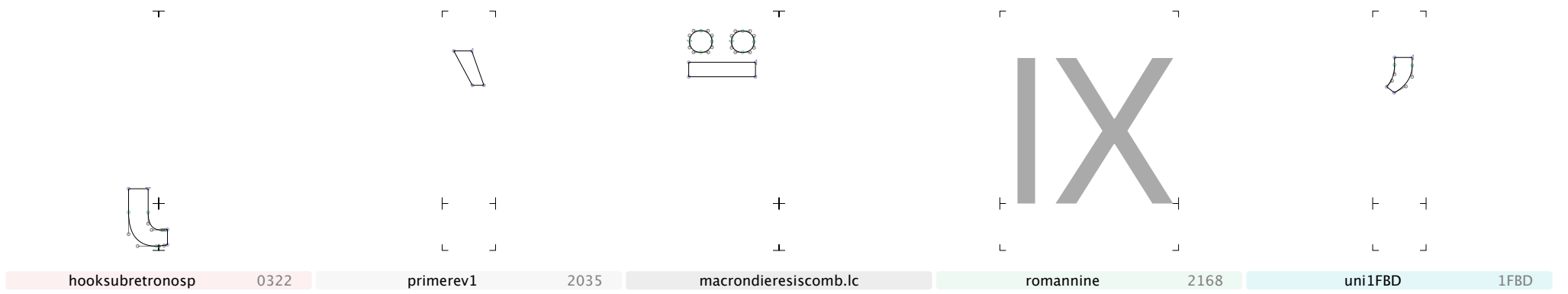
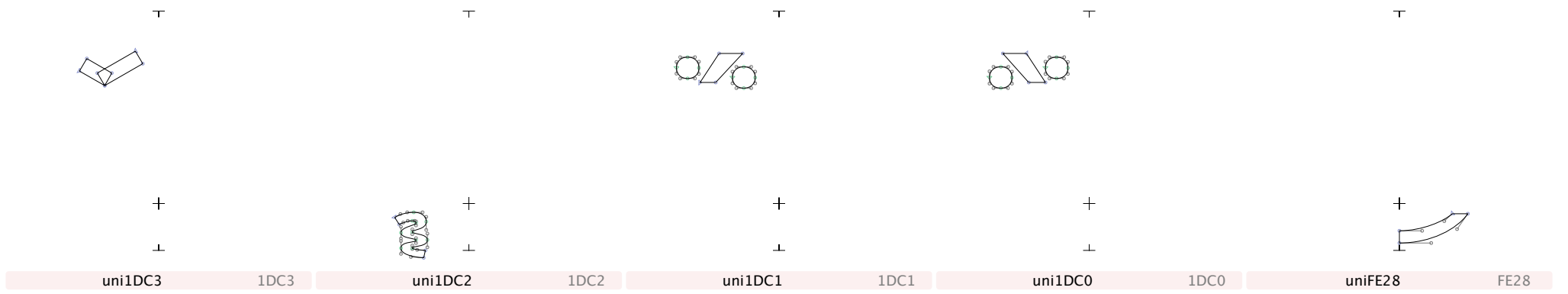
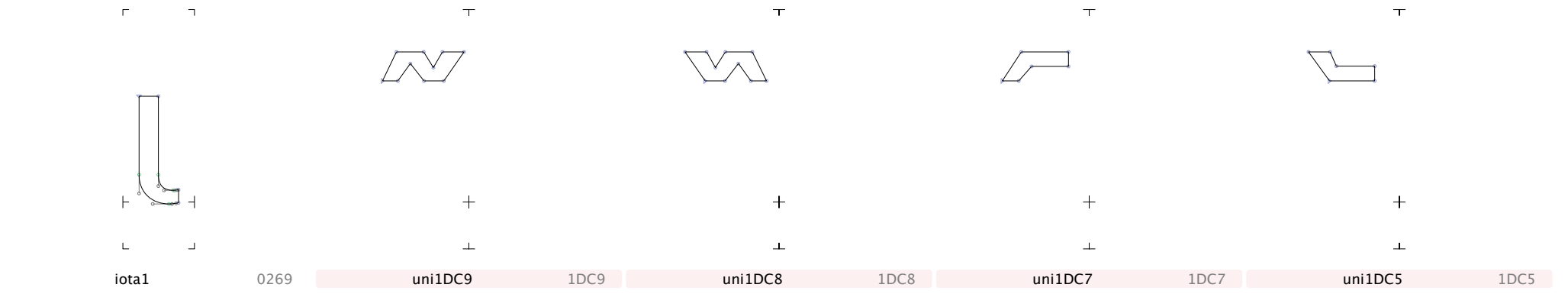
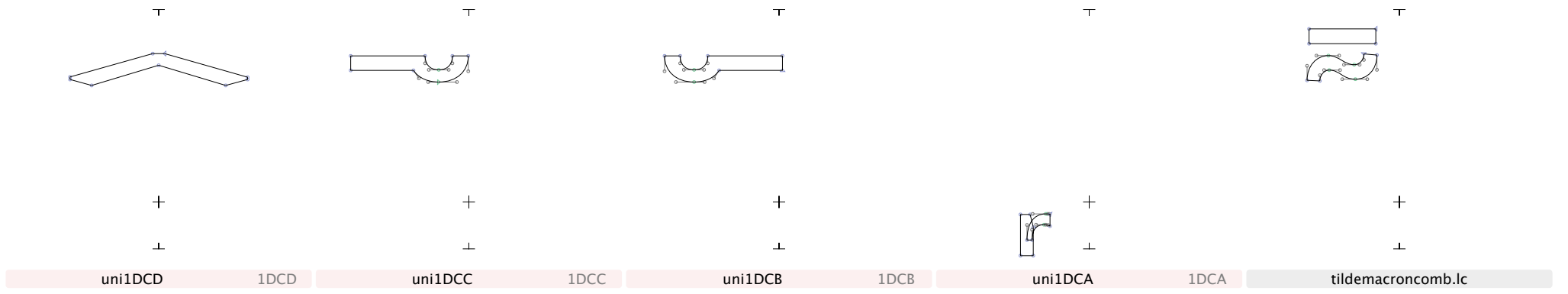
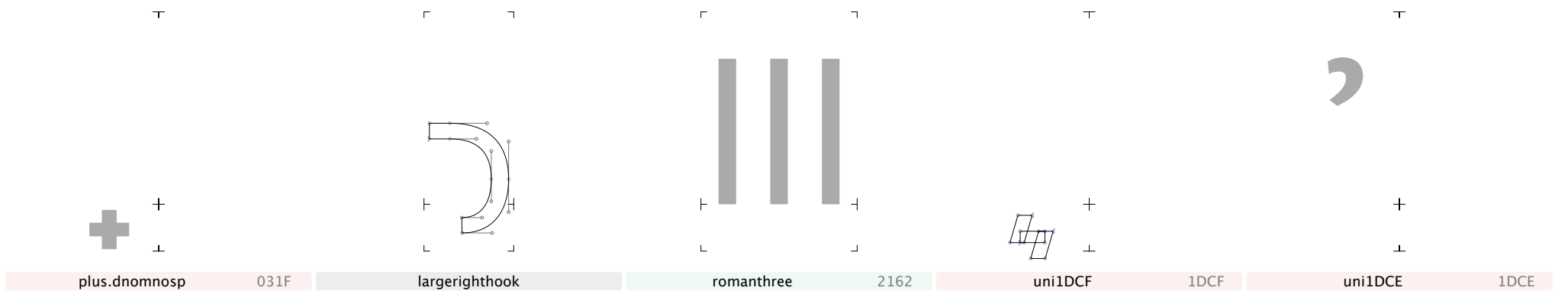

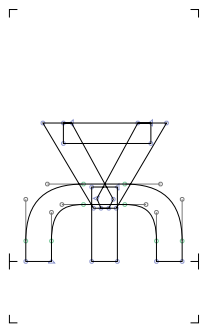

yusbigcyrillic 046B

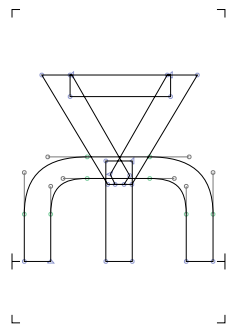

Yusbigcyrillic 046A

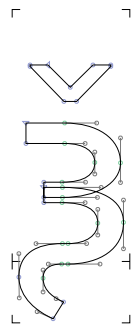

ksicyrillic 046F

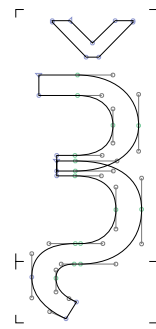

Ksicyrillic 046E

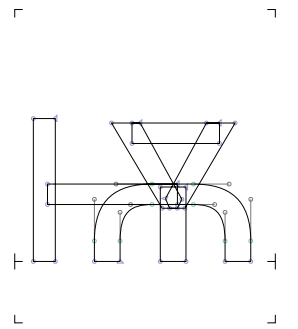

yusbigiotifiedcyrillic 046D



tildeacutecomb.lc



romanthousand 216F



macronsub 02CD



bullseye 0298

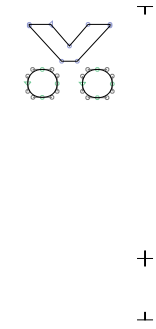

dieresiscaroncomb.lc

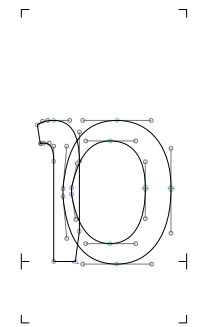

ascriptturn 0252

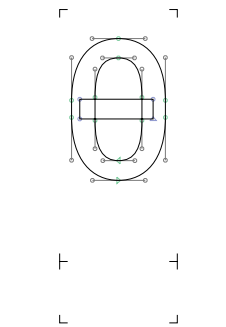

uni1DBF 1DBF



glottalstopbarrev 02A2



cyrillichook

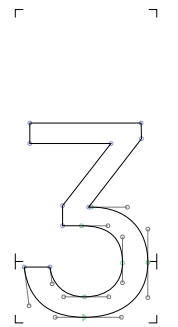

ezh 0292

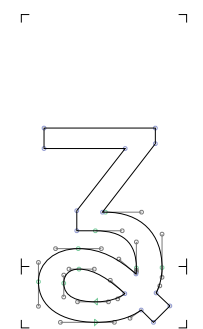

ezhcurl 0293

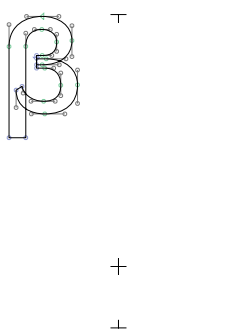

uni1DE9 1DE9



numeralgreek 0374

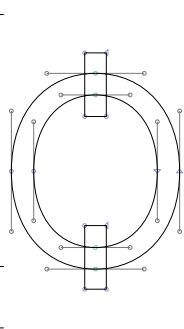

Omegaroundcyrillic 047A

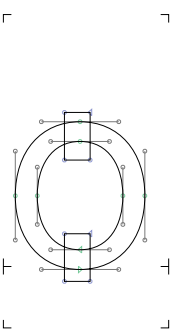

omegaroundcyrillic 047B

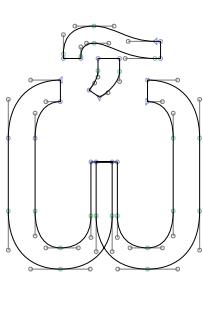

Omegatitlocyrillic 047C

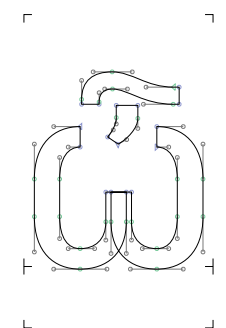

omegatitlocyrillic 047D

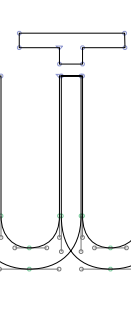

Otcyrillic 047E

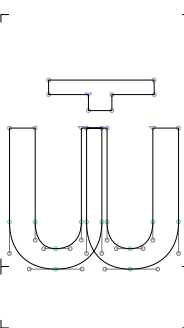

otcyrillic 047F



gcursive 0261

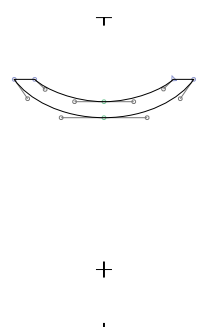

uni035D 035D

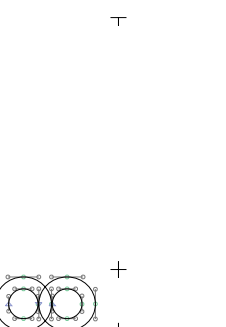

uni035A 035A



quotedblreversed 201F

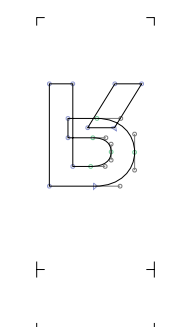

Rturnsuper 02B6

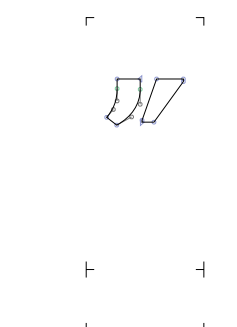

uni1FCE 1FCE

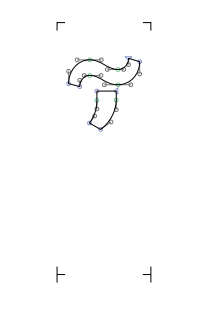

uni1FCF 1FCF

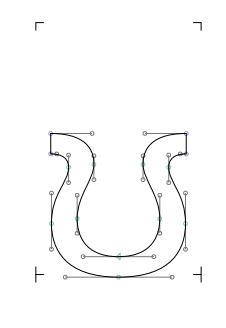

upsilonlatin 028A

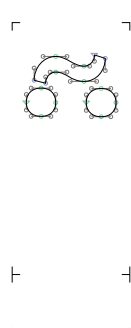

uni1FC1 1FC1



uni1FC0 1FC0

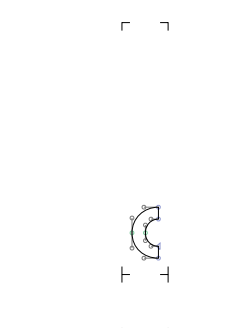

ringhalfleftcentered 02D3

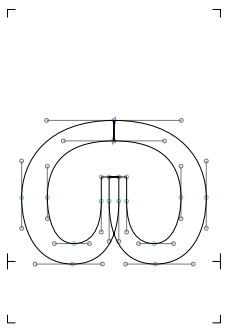

omegaclosed

0277

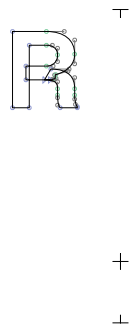

uni1DE2

1DE2

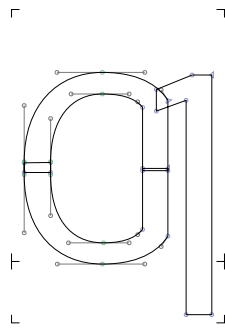

OI

01A2

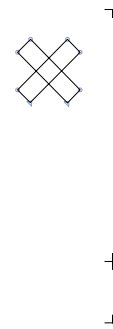

xsupnosp

033D

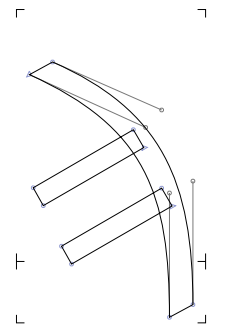

sampi

03E1

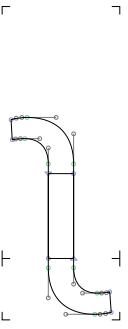

eshshortrev

0285

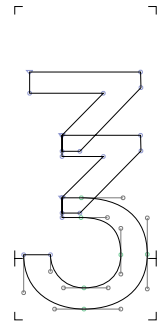

ounce

2125

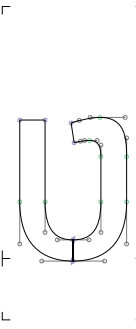

vscript

028B



acuterightnosp

0341

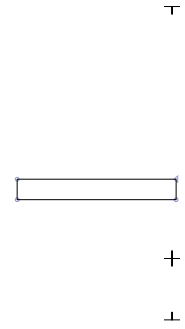

barmidlongnosp

0336



tildevertsupnosp

033E



linevertdbl nosp

030E

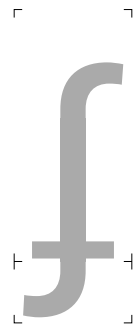

jhookdblbar

0284



overline

203E



ascript

0251

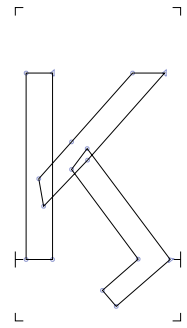

uni03CF

03CF



uni20DC

20DC



uni20DB

20DB



romansix

2165



uni1FBF

1FBF

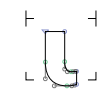

uni1FBE

1FBE



ypogegrammeni

037A



romaneight

2167

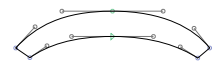

character tie

2040

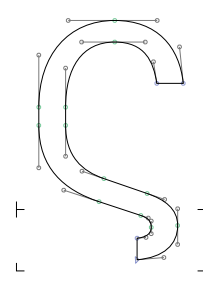

Stigma

03DA

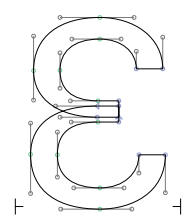

Epsilon1

0190

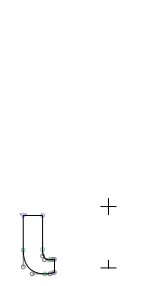

iotasubnosp

0345



pipedblbar

01C2

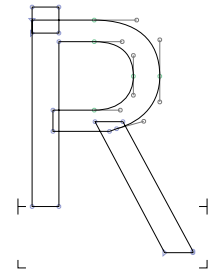

YR

01A6

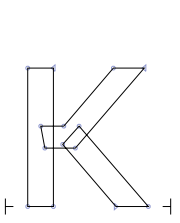

kgreenlandic

0138

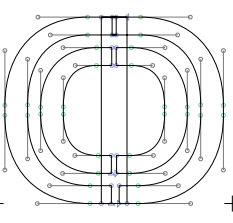

uni2182

2182

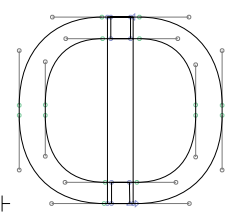

uni2180

2180

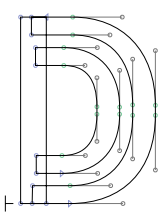

uni2181

2181

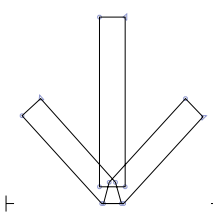

uni2186

2186

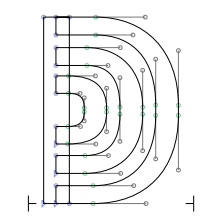

uni2187

2187

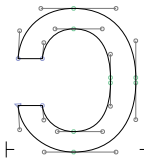

uni2184

2184

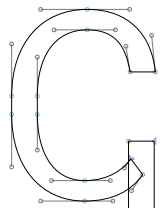

uni2185

2185

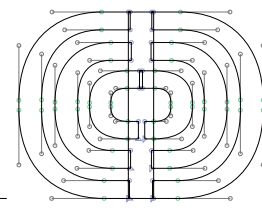

uni2188

2188

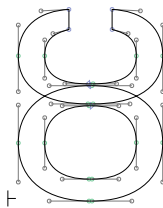

uni0222

0222



romanseven

2166

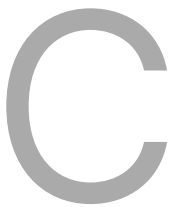

romanhundred

216D

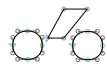

uni1FEE

1FEE

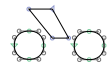

uni1FED

1FED



graveleftnosp

0340

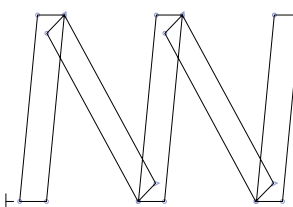

uniA7FF

A7FF

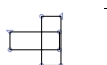

tackleftsubnosp

0318

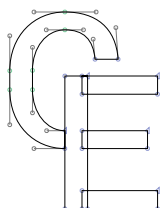

eurocurrency

20A0



uni20E8

20E8

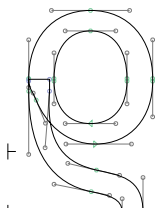

rho1

03F1

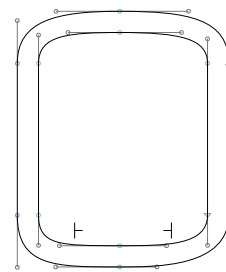

uni20E3

20E3



dblapostrophe

02EE

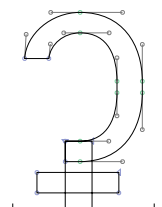

glottalstopbar

02A1



minus.dnomnosp

0320



rturnsuper

02B4



linevert

02C8



primetriplev1

2037



uni217F

217F



uni217E

217E



uni217D

217D



uni217C

217C



twelveroman

217B



elevenroman

217A

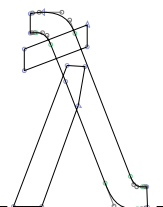

lambdabar

019B



pipe

01C0



tenroman

2179



nineroman

2178



eightroman

2177



sevenroman

2176













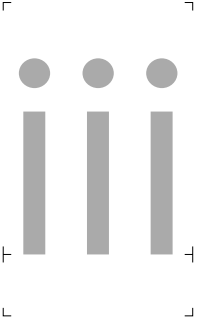
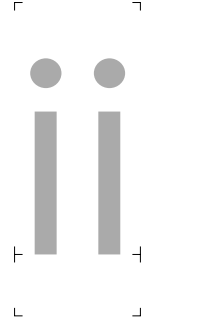

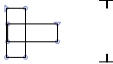
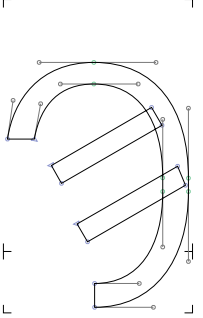
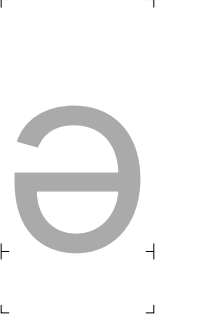
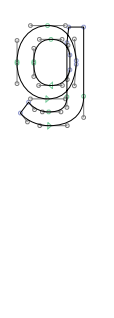
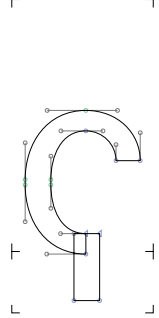
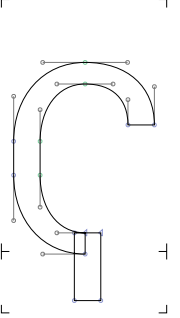
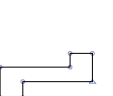
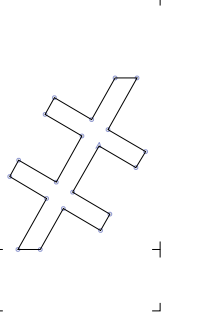

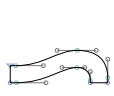
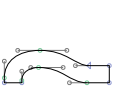

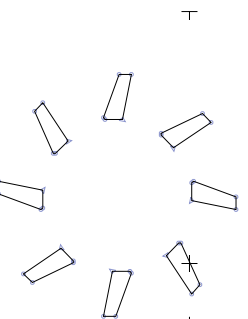
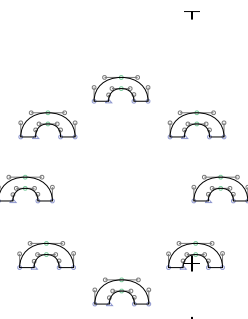
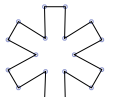
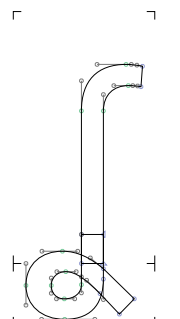
fiveroman

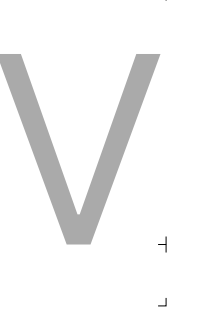
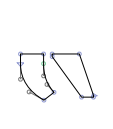
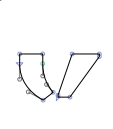
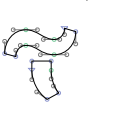
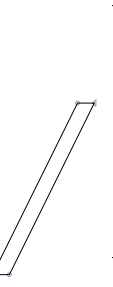
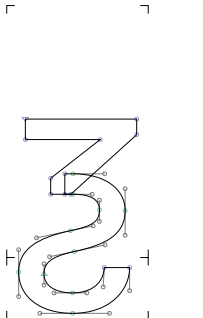
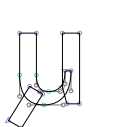
2174

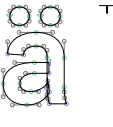

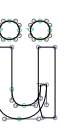
fourroman

2173

				
threeroman 2172	tworoman 2171	oneroman 2170	underscoredblensp 0333	tackrightsubnosp 0319
				
Sampi 03E0	schwa 0259	uni1DDA 1DDA	koppacyrillic 0481	Koppacyrillic 0480
				
titlocyrlliccmb 0483	thousandcyrillic 0482	dasiapneumatacyrlliccmb 0485	palatalizationcyrlliccmb 0484	uni0487 0487
				
psilipneumatacyrlliccmb 0486	uni0489 0489	uni0488 0488	uni20F0 20F0	eshcurl 0286
				
quotereversed 201B	romanfive 2164	uni1FDD 1FDD	uni1FDE 1FDE	uni1DFD 1DFD
				
slashshortnosp 0337	ezhtail 01BA	uni1DF0 1DF0	uni1DF1 1DF1	uni1DF2 1DF2
				
uni1DF3 1DF3	uni1DF4 1DF4	uni1DF5 1DF5	caronbelowcmb 032C	acutesubnosp 0317



romantwo 2161

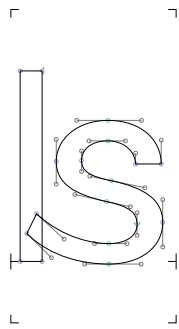

finalkaf 02AA

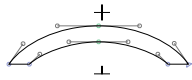

uni1DFC 1DFC

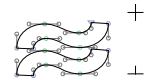

uni1DFD 1DFD



uni1DFE 1DFE

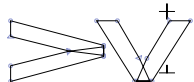

uni1DFF 1DFF



uni1FEF 1FEF



dblprimemod 02BA

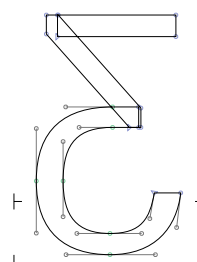

Ezhreversed 01B8

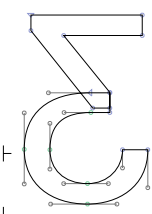

ezhreversed 01B9

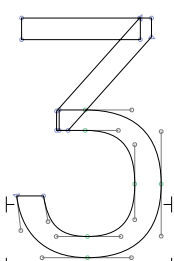

Ezh 01B7

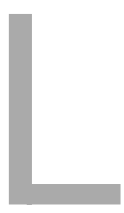

romanfifty 216C



ringhalfright 02BE

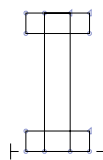

lsmallcap 026A



uptackmod 02D4



hyphendot 2027



uniFE29 FE29

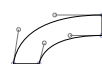

uniFE20 FE20

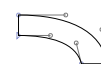

uniFE21 FE21



uniFE22 FE22



uniFE23 FE23



uniFE24 FE24



uniFE25 FE25

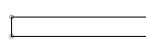

uniFE26 FE26

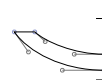

uniFE27 FE27

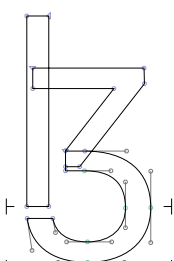

lyogh 026E

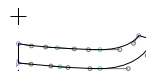

uniFE2A FE2A



uniFE2B FE2B



uniFE2C FE2C



uniFE2D FE2D

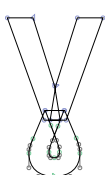

gammaster 02E0

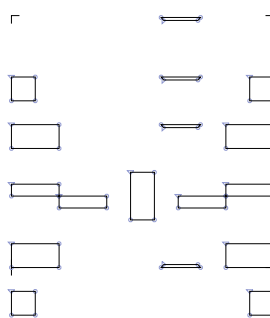

uniE001 E001

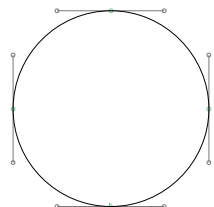

circleblack 25CF

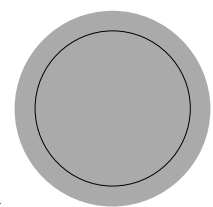

circlewhite 25CB

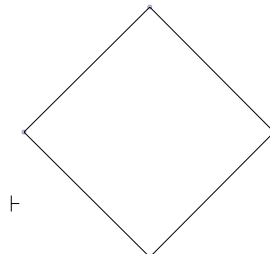

diamondblack 25C6

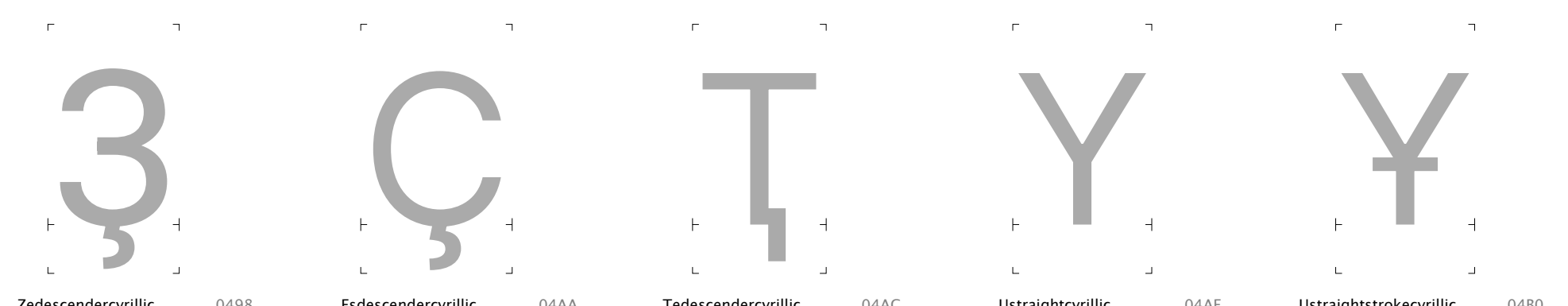
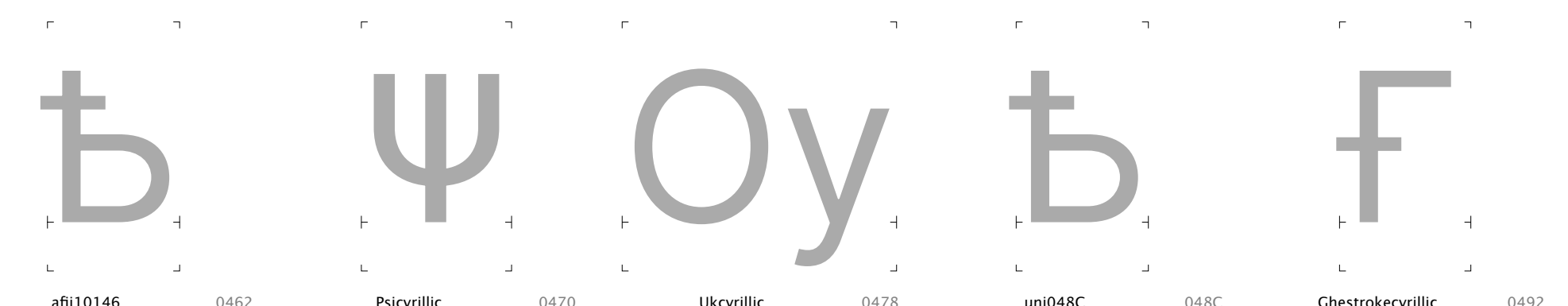
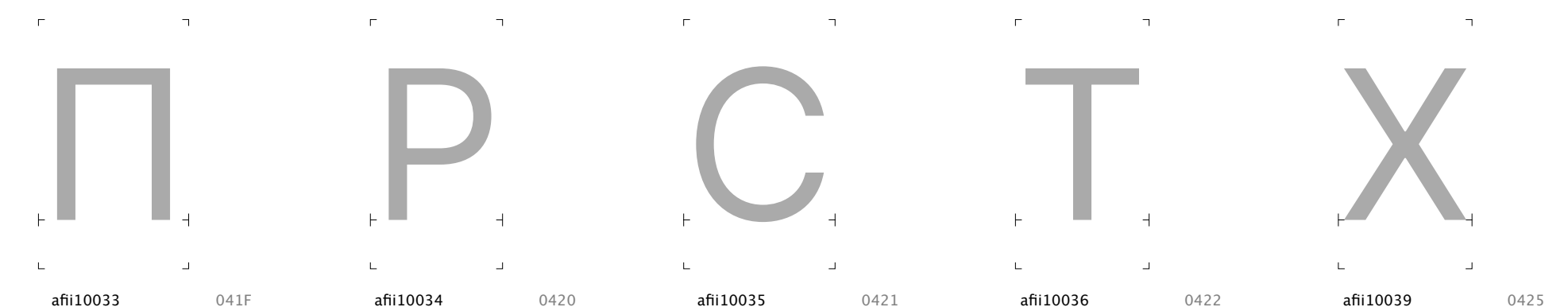
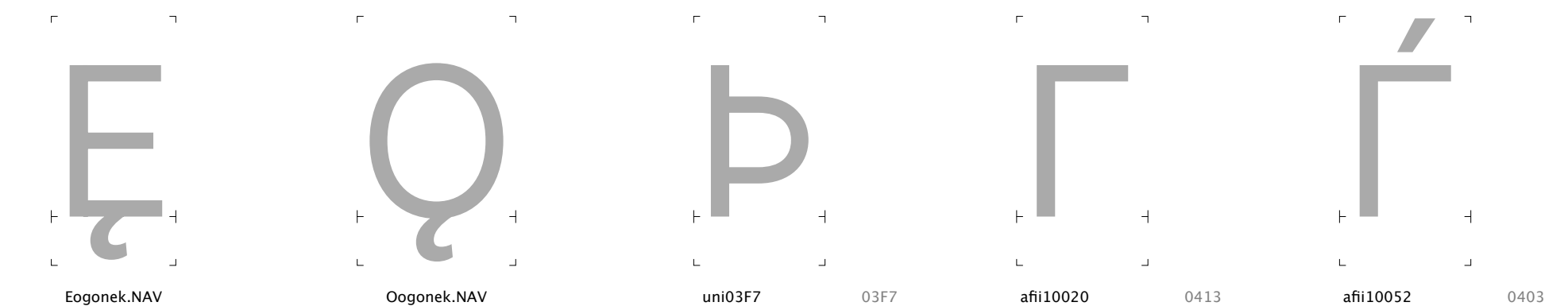
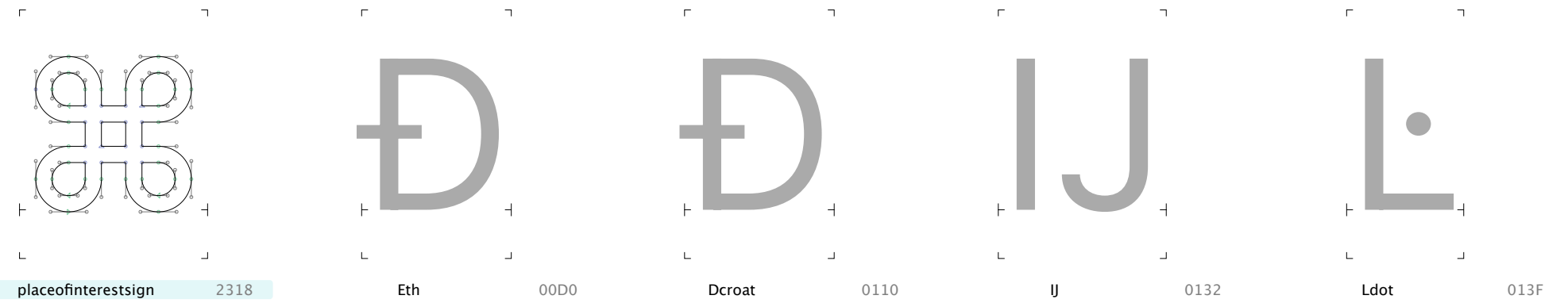
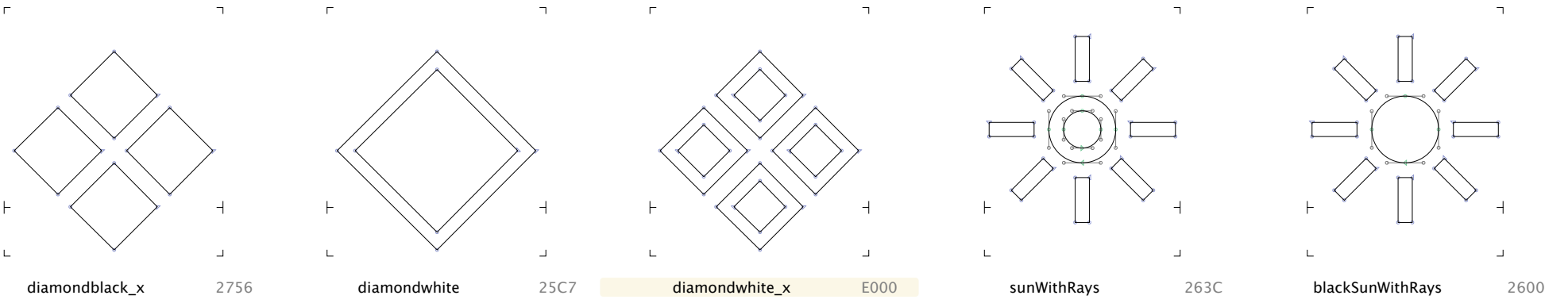



Chedescenderabkhasiancyrillic 04BE



palochkacyrillic 04C0



Chekhakassiancyrillic 04CB



uni04F6 04F6

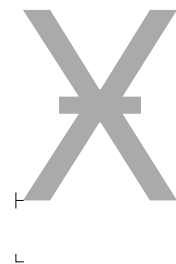

uni04FE 04FE

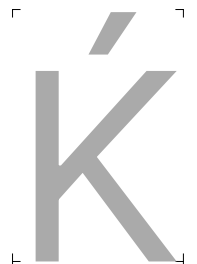

afi10061 040C



Schwadieseriscyrillic 04DA

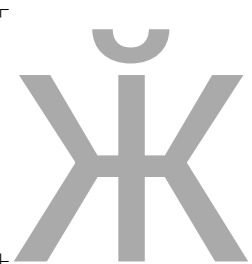

Zhebrevecyrillic 04C1

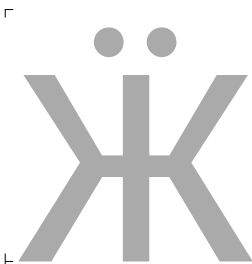

Zhedierescyrillic 04DC



Zedierescyrillic 04DE



afi10062 040E



Umacroncyrillic 04EE



Udierescyrillic 04F0



Uhungarumlautcyrillic 04F2



Chedierescyrillic 04F4



Yerudierescyrillic 04F8



uni04EC 04EC



Izhitsadblgravecyrillic 0476



uni0299 0299



uni029C 029C



aogonek.NAV

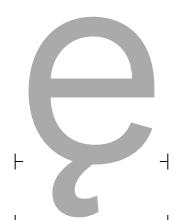

eogonek.NAV

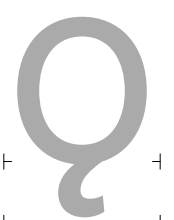

oogonek.NAV



kappa 03BA



mugreek 03BC

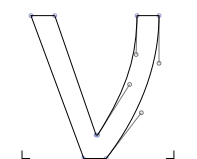

nu 03BD

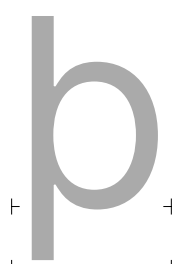

uni03F8 03F8



uni1F71 1F71



uni1F73 1F73

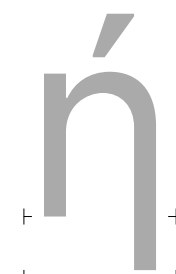

uni1F75 1F75

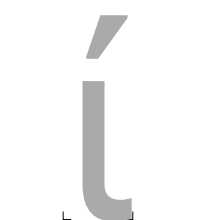

uni1F77 1F77



uni1F79 1F79

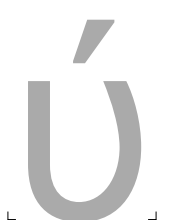

uni1F7B 1F7B



uni1F7D 1F7D



uni1FD3 1FD3

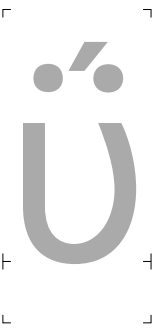

uni1FE3

1FE3



psicyrillic

0471



ghestrokecyrillic

0493



zedescendercyrillic

0499



esdescendercyrillic

04AB

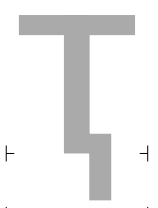

tedescendercyrillic

04AD

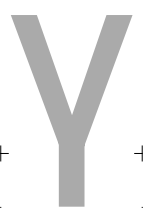

ustraightcyrillic

04AF



ustraightstrokecyrillic

04B1

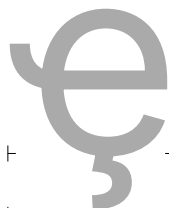

chedescenderabkhasiancyrillic

04BF



chekhakassiancyrillic

04CC

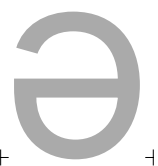

schwacyrillic

04D9



schwadiesiscyrlilic

04DB



obarredcyrillic

04E9



obarreddieriscyrlilic

04EB

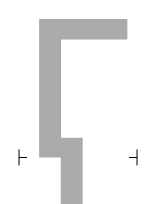

uni04F7

04F7

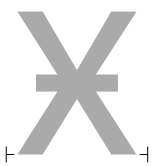

uni04FF

04FF



chedieriscyrlilic

04F5



uni04ED

04ED



gjecyrlilic

0453



iishortcyrlilic

0439



uni045D

045D



imacroncyrlilic

04E3



idieriscyrlilic

04E5



izhitsadblgravecyrlilic

0477

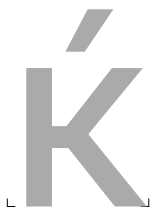

kjecyrlilic

045C



yerudieriscyrlilic

04F9



zedieriscyrlilic

04DF



zhebrevcyrlilic

04C2



zhedieriscyrlilic

04DD



Ezhcaron

01EE

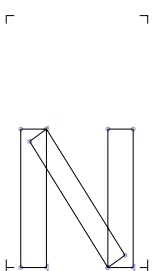

Nsmallcap

0274

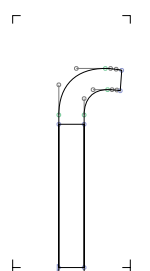

esh

0283

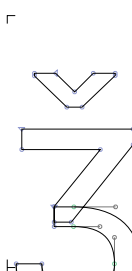

ezhcaron

01EF

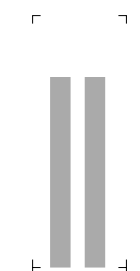

pipdbl

01C1



uni2094

2094



uni02B2.ccmp

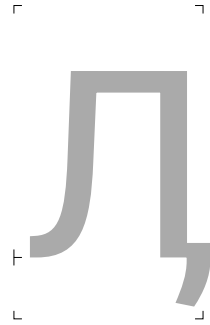

Eltail-cy

04C5

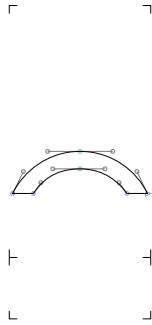

uniA92E

A92E

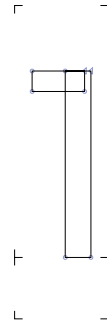

tonebarextrahighmod.cn

02E5

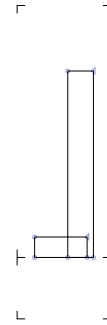

tonebarextralowmod.cn

02E9

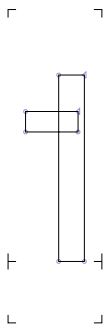

tonebarhighmod.cn

02E6

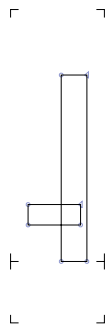

tonebarlowmod.cn

02E8

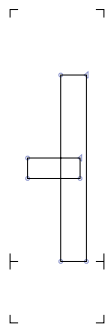

tonebarmidmod.cn

02E7



commaabovecmb

0313



commaaboverightcmb

0315



uni1DE7

1DE7

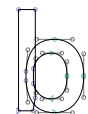

uni1DE8

1DE8



uni1DEA

1DEA



hooksubpalatnosp

0321



bridgeinvsbnosp

033A

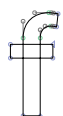

uni1DEB

1DEB

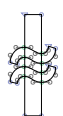

uni1DEC

1DEC

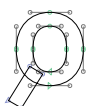

uni1DED

1DED



uni1DEE

1DEE



uni1DEF

1DEF



macronacutecomb.cn



macrongravecomb.cn



uni1FFE.tonos



uni1FCD.tonos



uni1FDD.tonos



uni1FCE.tonos



uni1FDE.tonos



uni1FCF.tonos



uni1FDF.tonos



uni1FEF.tonos



uni1FFD.tonos



uni1DE0

1DE0



uni1DE1

1DE1













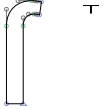
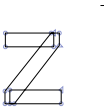



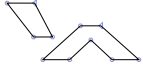

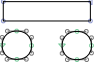





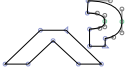

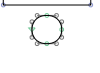
uni1DE3

1DE3

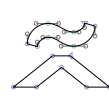

uni1DE4

1DE4

						
uni1DE5	1DE5	uni1DE6	1DE6	cyrillictic.cn	controlHT	controlSOT
						
commaaccentright.cn	ringacute.cn	circumflexgravecomb.cn	dieresisacaroncomb.cn	dieresismacroncomb.cn		
						
carondotcomb.cn	breveacutecomb.cn	acutedotcomb.cn	brevegravecomb.cn	circumflexacutecomb.cn		
						
tildeacaroncomb.cn	circumflexhookcomb.cn	brevetildecomb.cn	dieresisacutecomb.cn	dotmacroncomb.cn		
						
macrodieresiscomb.cn	dieresisgravecomb.cn	tildemacroncomb.cn	circumflextildecomb.cn	brevehookcomb.cn		
						
commaaccentrotate.cn	tildeacutecomb.cn	tonostop	cyrillictail.cn	koronisaccentleft.cn		