

A 0041

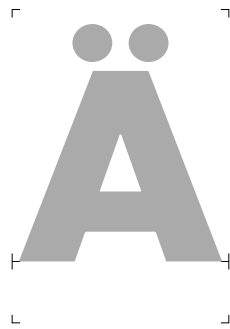

Adieresis 00C4

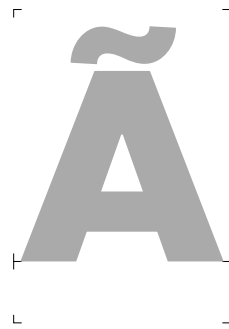

Atilde 00C3

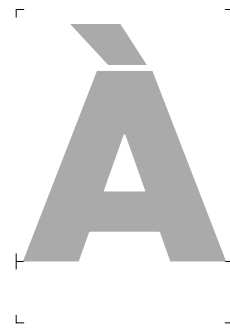

Agrave 00C0

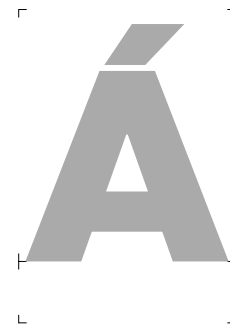

Aacute 00C1

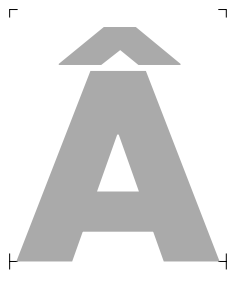

Acircumflex 00C2

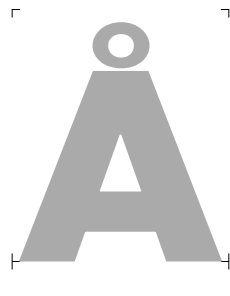

Aring 00C5



Amacron 0100

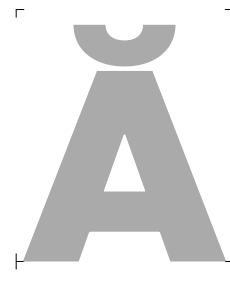

Abreve 0102

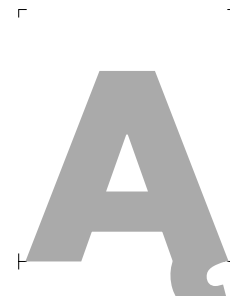

Aogonek 0104

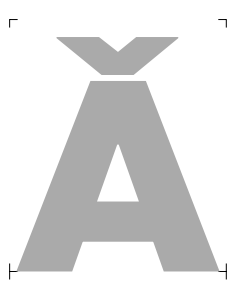

Acaron 01CD

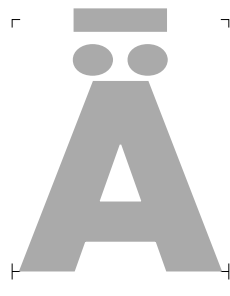

Adieresismacron 01DE



Adotmacron 01E0

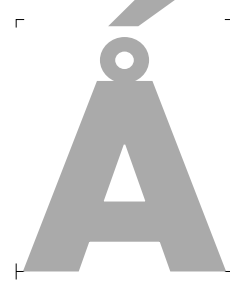

Aringacute 01FA



Abligraev 0200

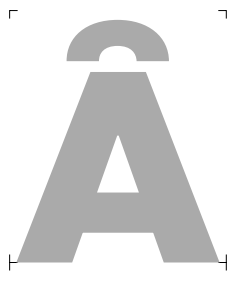

Ainvertedbreve 0202

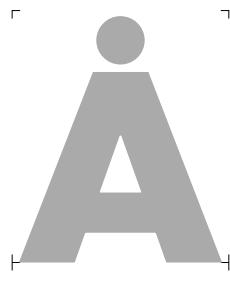

uni0226 0226



Aringbelow 1E00



Adotbelow 1EA0



Ahookabove 1EA2

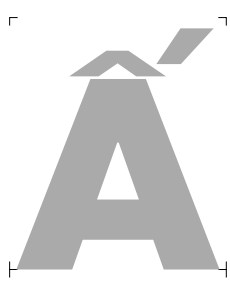

Acircumflexacute 1EA4

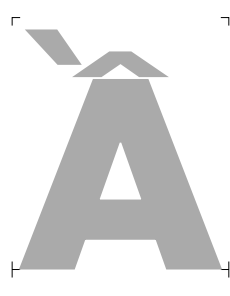

Acircumflexgrave 1EA6

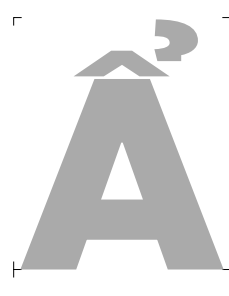

Acircumflexhookabove 1EA8

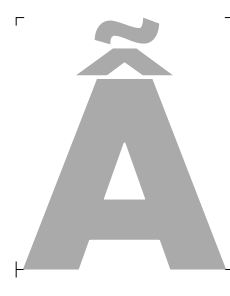

Acircumflextilde 1EAA

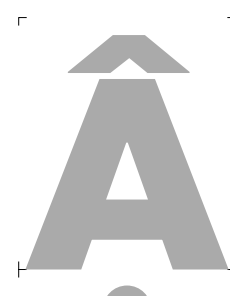

Acircumflexdotbelow 1EAC

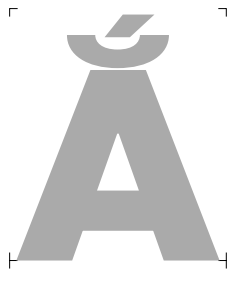

Abreveacute 1EAE

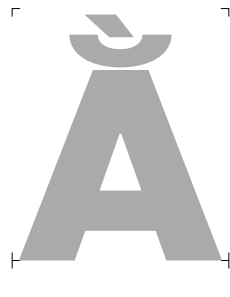

Abrevegrave 1EB0

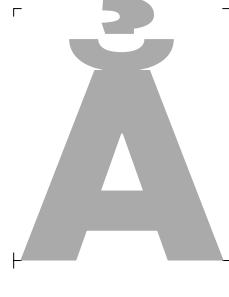

Abrevehookabove 1EB2

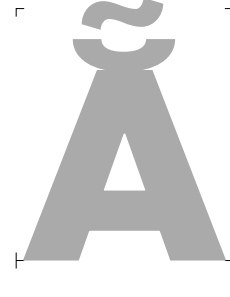

Abrevetilde 1EB4

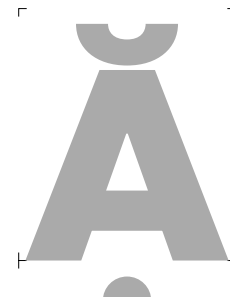

Abrevedotbelow 1EB6



Alpha 0391



Alphatonos 0386



uni1F08 1F08



uni1F09 1F09



uni1F0A 1F0A

uni1F0B 1F0B uni1F0C 1F0C uni1F0D 1F0D uni1F0E 1F0E uni1F0F 1F0F

uni1F88 1F88 uni1F89 1F89 uni1FBA 1FBA uni023A 023A uni1FBB 1FBB

afii10017 0410 Abrevcyrillic 04D0 Adieresiscyrillic 04D2 uni1F88 1F88 uni1F89 1F89

uni1F8A 1F8A uni1F8B 1F8B uni1F8C 1F8C uni1F8D 1F8D uni1F8E 1F8E

uni1F8F 1F8F uni1FBC 1FBC Lambda 039B AE 00C6 AEmacron 01E2

AEacute 01FC Aiecyrillic 04D4 B 0042 Bdotaccent 1E02 Bdotbelow 1E04

Blinebelow 1E06 uni0243 0243 Bhook 0181 afii10019 0412 Beta 0392

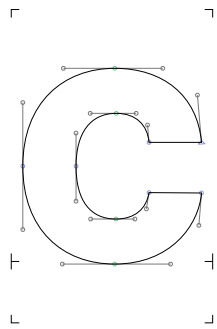

C 0043

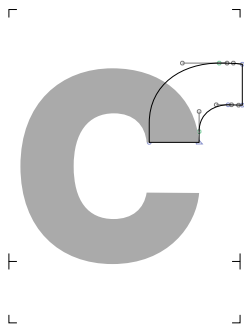

Chook 0187

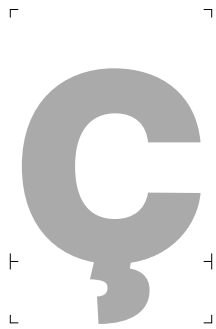

Ccedilla 00C7

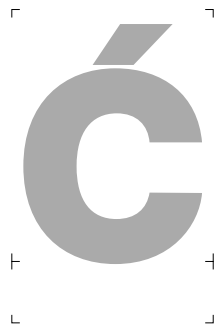

Cacute 0106

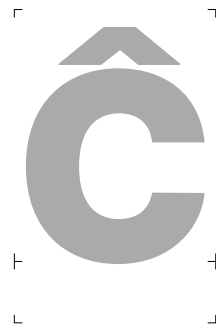

Ccircumflex 0108

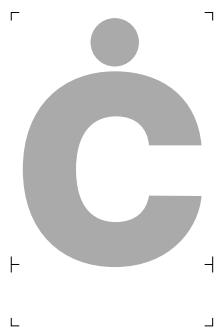

Cdotaccent 010A

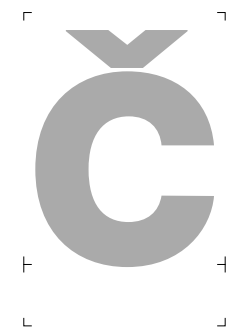

Ccaron 010C

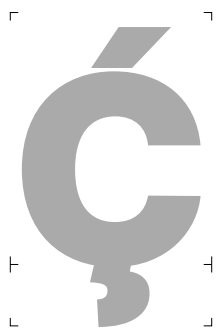

Ccedillaacute 1E08

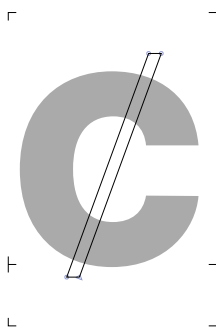

uni023B 023B

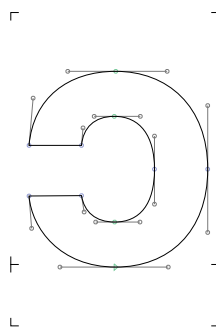

Oopen 0186

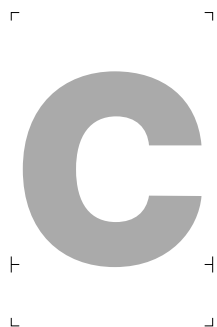

uni03F9 03F9

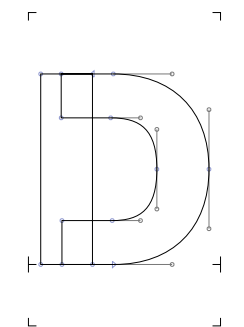

D 0044

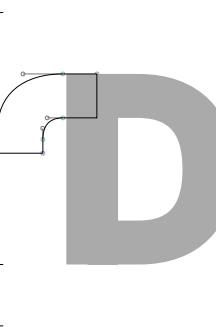

Dhook 018A

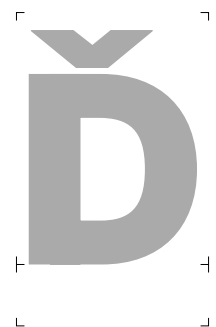

Dcaron 010E

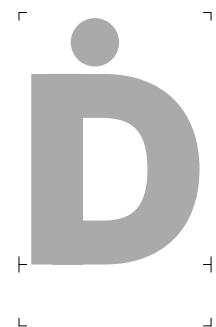

Ddotaccent 1E0A

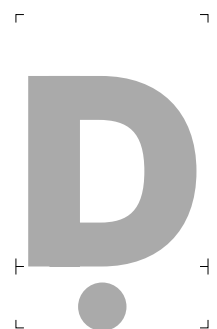

Ddotbelow 1E0C

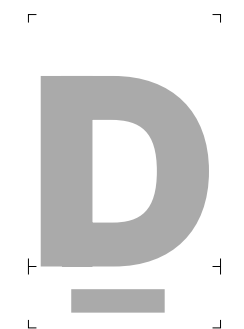

Dlinebelow 1E0E

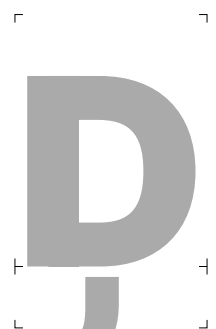

Dcedilla 1E10

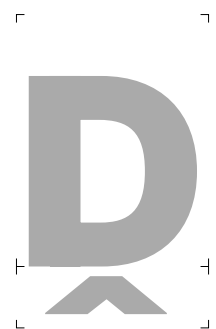

Dcircumflexbelow 1E12

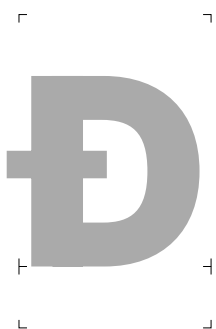

Dbar1 0189



Dz 01F2



Dzcaron\_ 01C5

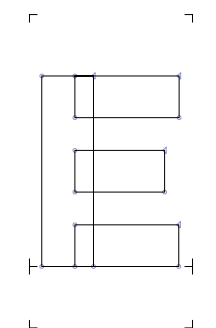

E 0045

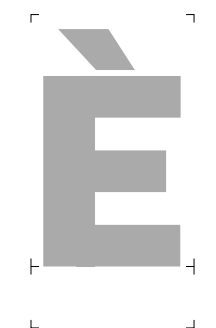

Egrave 00C8

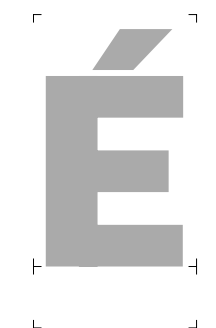

Eacute 00C9

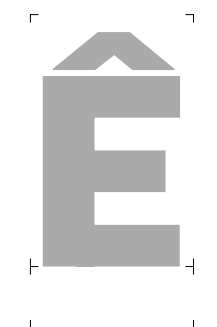

Ecircumflex 00CA

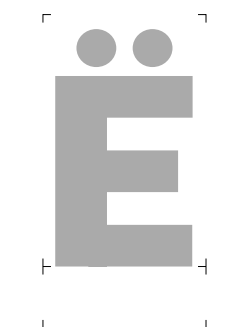

Edieresis 00CB

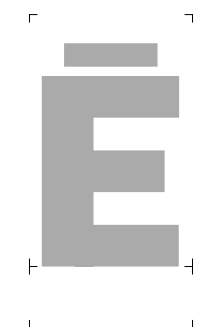

Emacron 0112

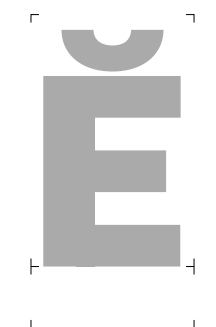

Ebreve 0114

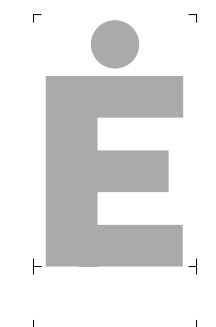

Edotaccent 0116

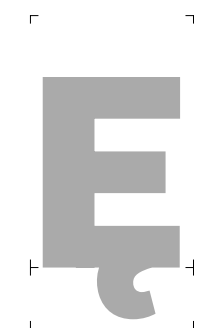

Eogonek 0118

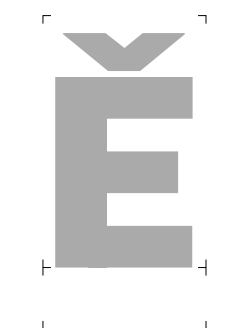

Ecaron 011A



Edblgrave 0204

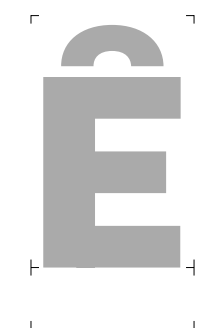

Einvertedbreve 0206

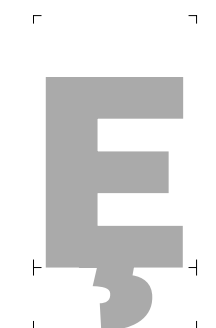

uni0228 0228



Emacrongrave 1E14



Emacronacute 1E16



Ecircumflexbelow 1E18



Etildebelow 1E1A



Ecedillabreve 1E1C



Edotbelow 1EB8



Ehookabove 1EBA



Etilde 1EBC



Ecircumflexacute 1EBE



Ecircumflexgrave 1EC0



Ecircumflexhookabove 1EC2



Ecircumflextilde 1EC4



Ecircumflexdotbelow 1EC6

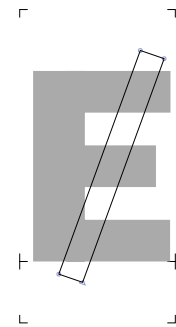

uni0246 0246



Eturn 018E



Epsilon 0395



Epsilontonos 0388



uni1F18 1F18



uni1F19 1F19



uni1F1A 1F1A



uni1F1B 1F1B



uni1F1C 1F1C



uni1F1D 1F1D



uni1FC8 1FC8

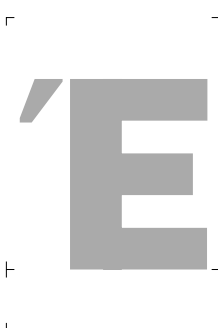

uni1FC9 1FC9



afii10022 0415



uni0400 0400



afii10023 0401



lebrevecyrillic 04D6

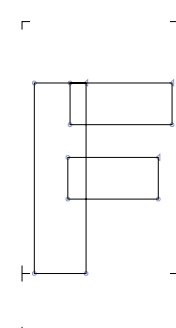

F 0046



Fhook 0191



Fdotaccent 1E1E



Fturn 2132

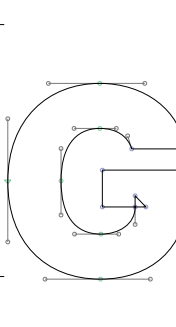

G 0047



Gbar 01E4

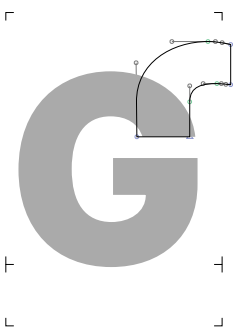

Ghook 0193



Gcircumflex 011C



Gbreve 011E



Gdotaccent 0120



Gcommaaccent 0122



Gcaron 01E6



Gacute 01F4



Gmacron 1E20

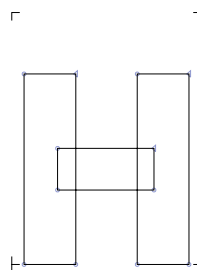

H 0048

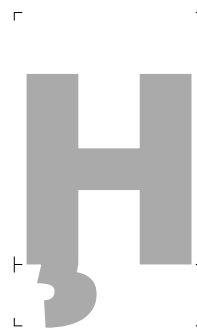

Hcedilla 1E28



Hcircumflex 0124



uni021E 021E



Hdotaccent 1E22

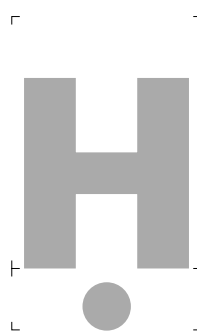

Hdotbelow 1E24



Hdieresis 1E26

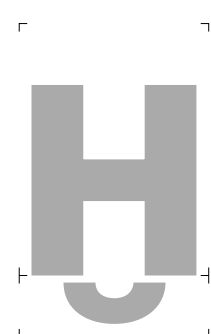

Hbrevebelow 1E2A

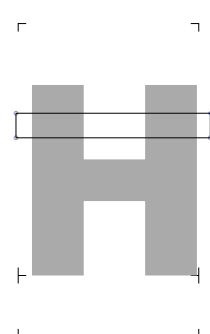

Hbar 0126

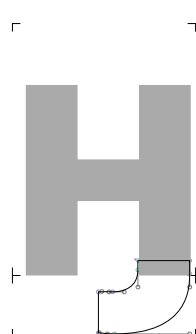

Enhookcyrillic 04C7



Endescendercyrillic 04A2



uni04C9 04C9

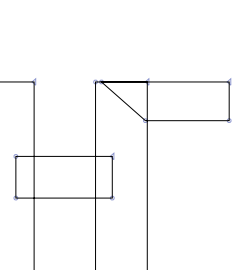

Enghecyrillic 04A4

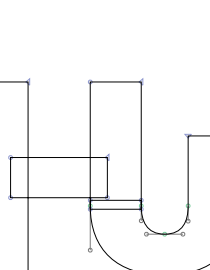

uni01F6 01F6



Eta 0397



Eatonos 0389



uni1F28 1F28



uni1F29 1F29



uni1F2A 1F2A



uni1F2B 1F2B



uni1F2C 1F2C



uni1F2D 1F2D



uni1F2E 1F2E



uni1F2F 1F2F



uni1FCA 1FCA



uni1FCB 1FCB



afii10031 041D

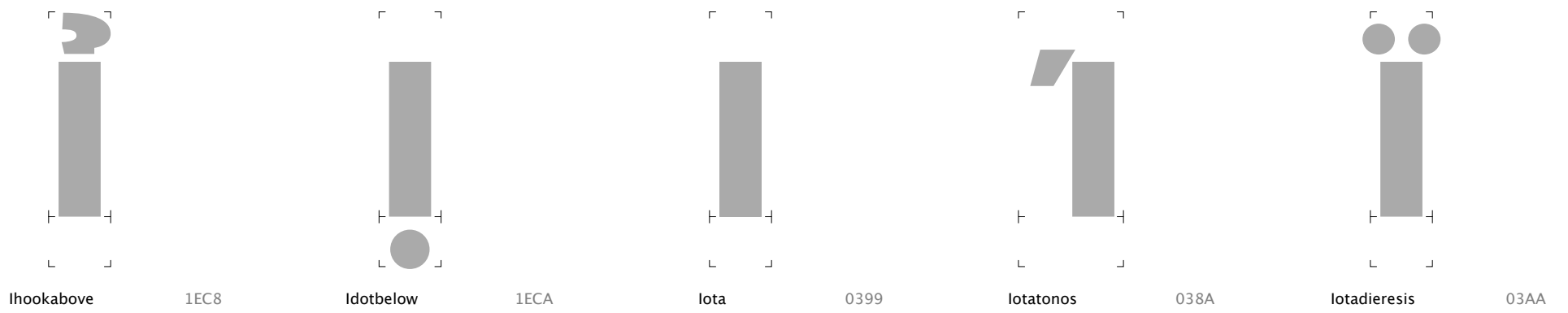
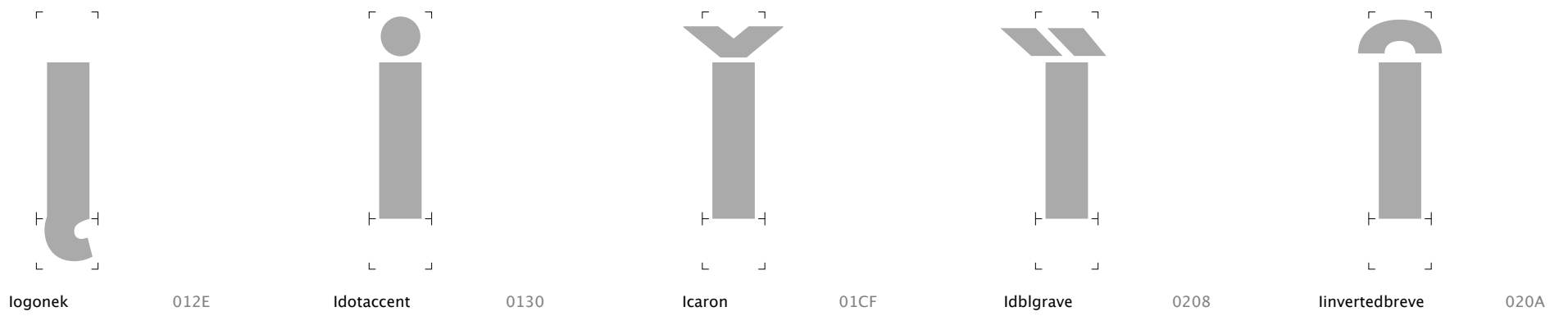
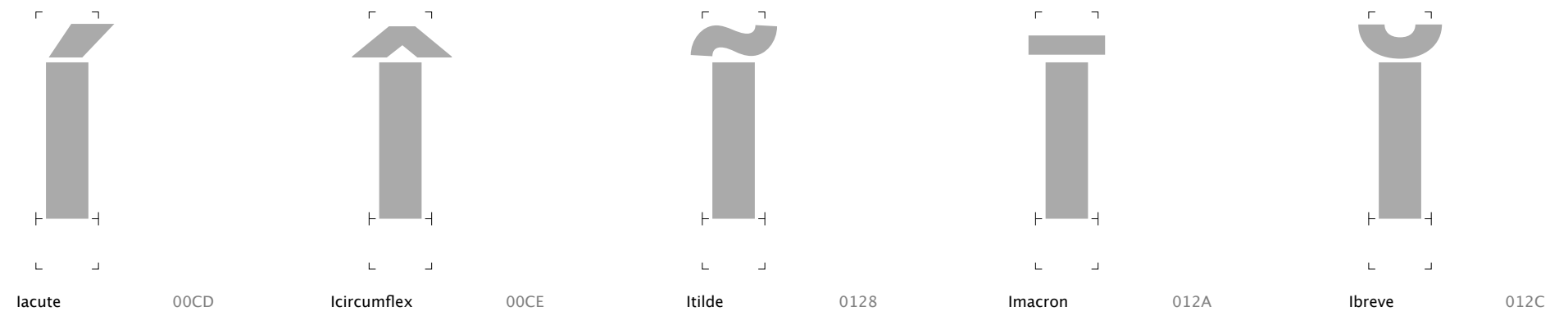
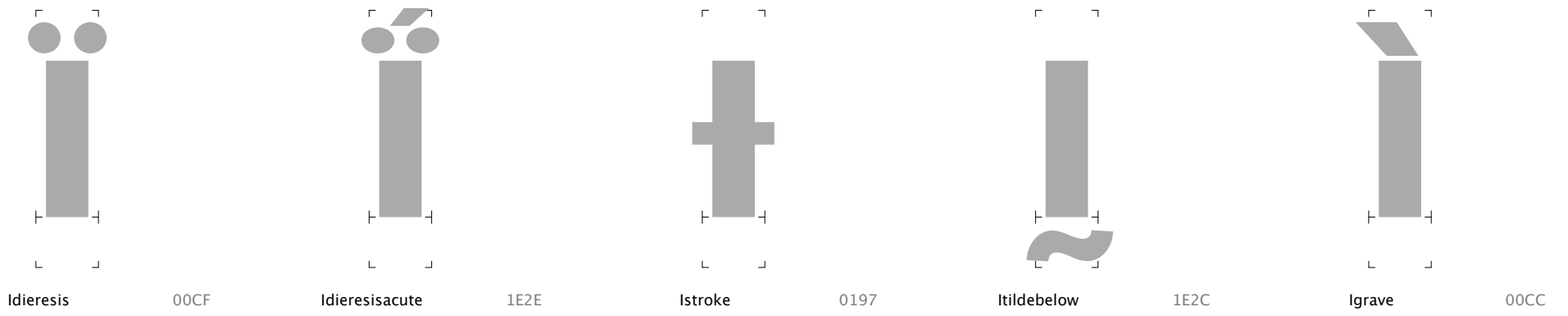
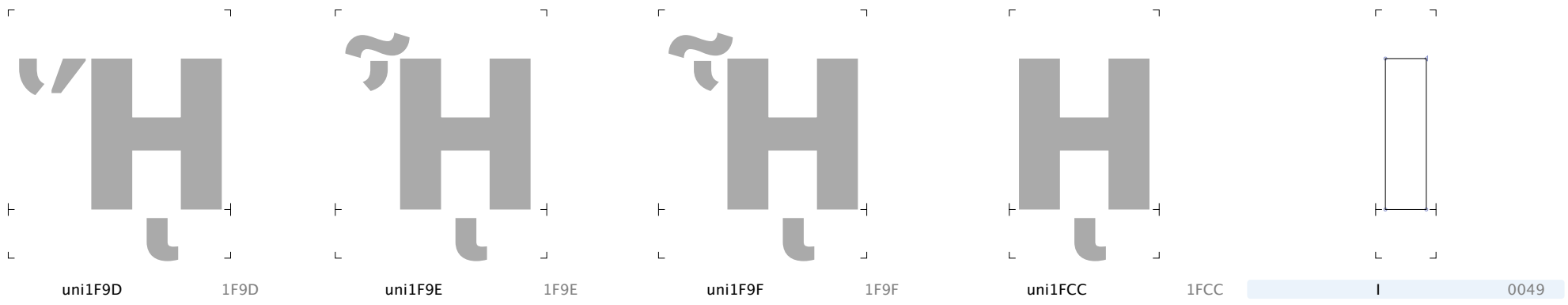
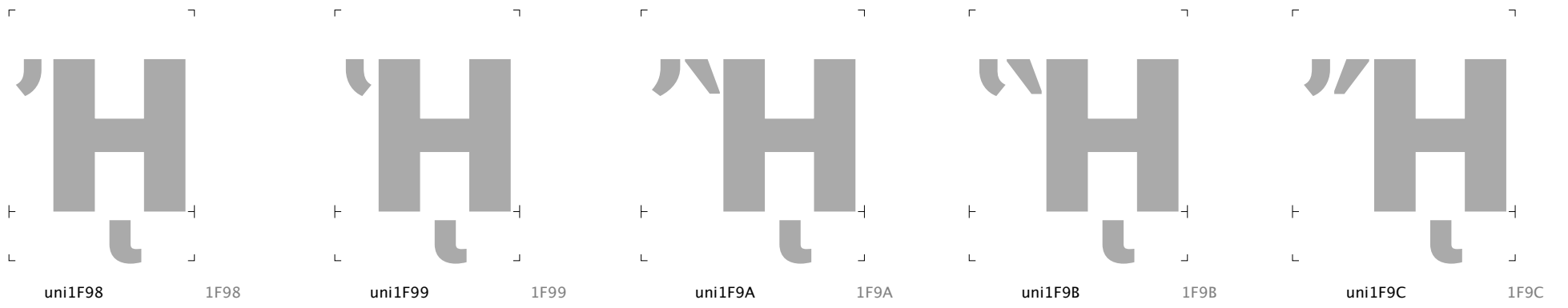

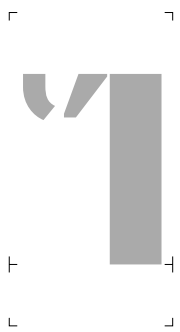

uni1F3D 1F3D



uni1F3E 1F3E

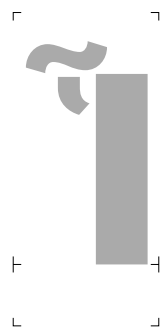

uni1F3F 1F3F



uni1FD8 1FD8



uni1FD9 1FD9

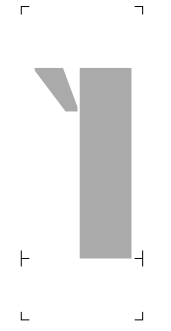

uni1FDA 1FDA



uni1FDB 1FDB

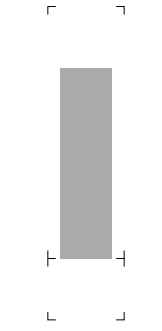

afii10055 0406



afii10056 0407

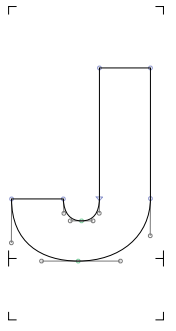

J 004A

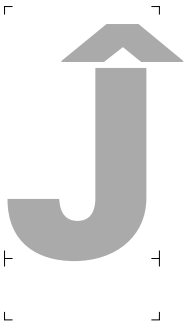

Jcircumflex 0134



uni0248 0248



uni037F 037F



afii10057 0408

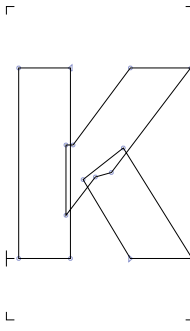

K 004B

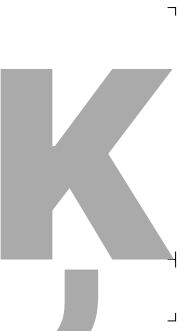

Kcommaaccent 0136



Kcaron 01E8



Kacute 1E30



Kdotbelow 1E32

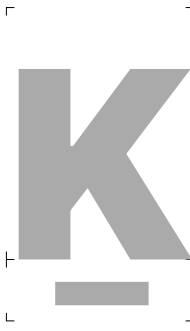

Klinebelow 1E34



Kabashkircyrillic 04A0



Kadescendcyrillic 049A

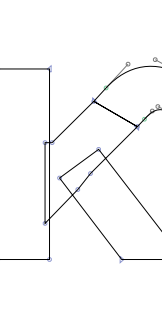

Khook 0198



Kappa 039A

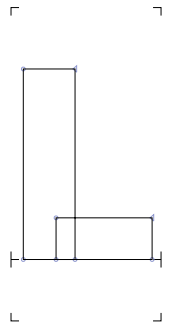

L 004C



Lacute 0139



Lcommaaccent 013B



Lcaron 013D



Ldotbelow 1E36

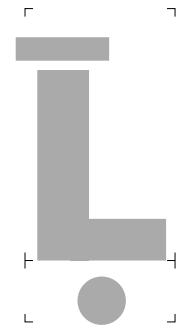

Ldotbelowmacron 1E38



Llinebelow 1E3A



Lcircumflexbelow 1E3C

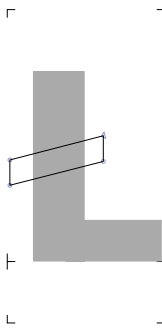

Lslash 0141



Lbar 023D



Lj 01C8

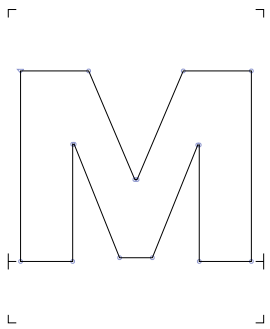

M 004D



Macute 1E3E



Mdotaccent 1E40



Mdotbelow 1E42

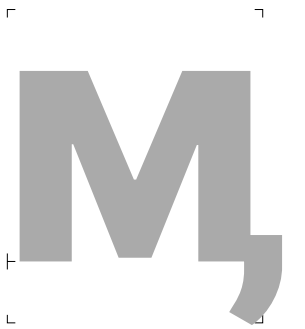

uni04CD 04CD



Mu 039C



uni03FA 03FA



afii10030 041C

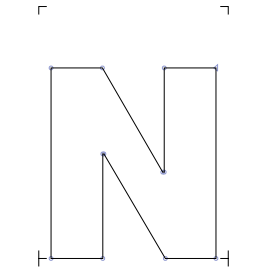

N 004E

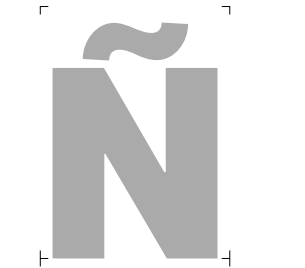

Ntilde 00D1

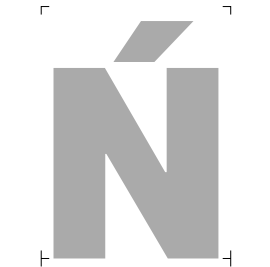

Nacute 0143

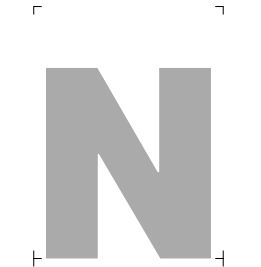

Ncommaaccent 0145



Ncaron 0147

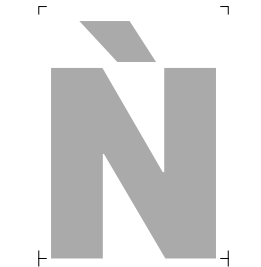

uni01F8 01F8

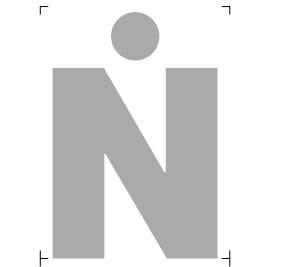

Ndotaccent 1E44

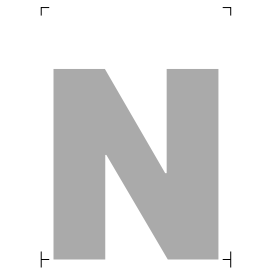

Ndotbelow 1E46

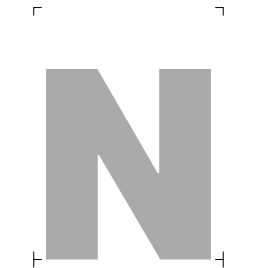

Nlinebelow 1E48

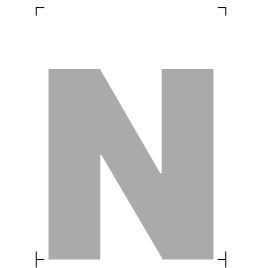

Ncircumflexbelow 1E4A

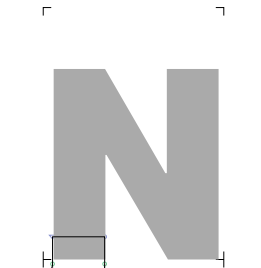

Nhook 019D

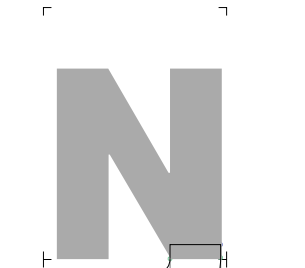

Eng 014A

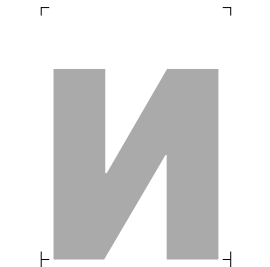

afii10026 0418

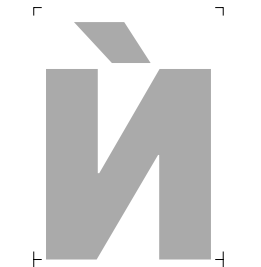

uni040D 040D

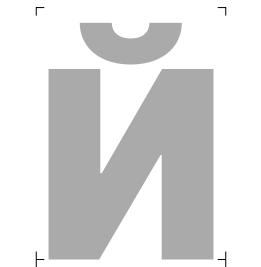

afii10027 0419

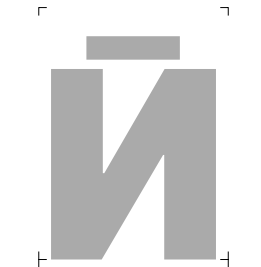

Imacroncyrillic 04E2

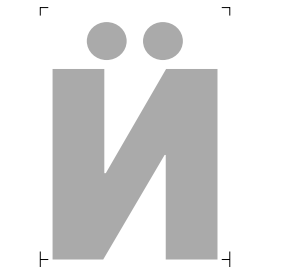

Idieresiscyrillic 04E4

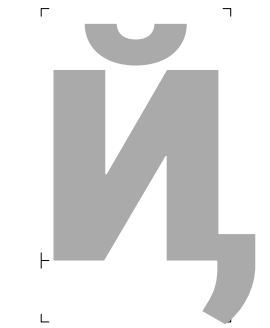

uni048A 048A



uni0376 0376



Nu 039D



Nj 01CB

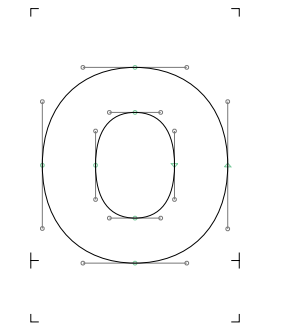

O 004F

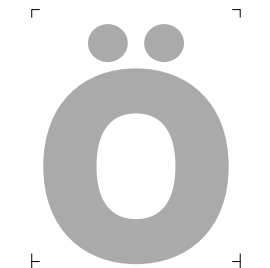

Odiereis 00D6

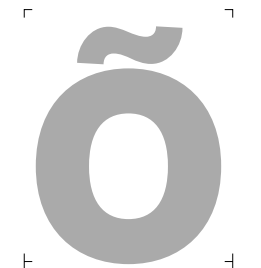

Otilde 00D5

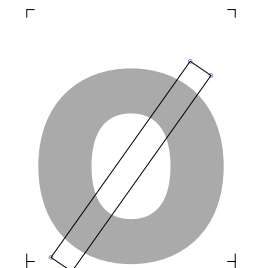

Oslash 00D8

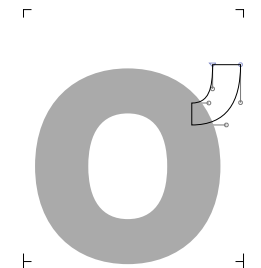

Ohorn 01A0

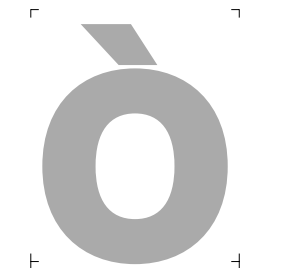

Ograve 00D2



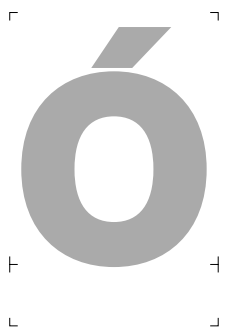

Oacute 00D3

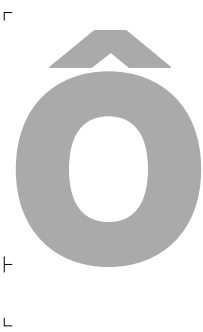

Ocircumflex 00D4

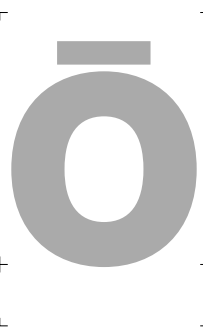

Omacron 014C

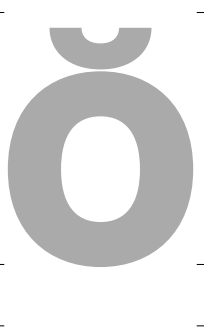

Obreve 014E



Ohungarumlaut 0150

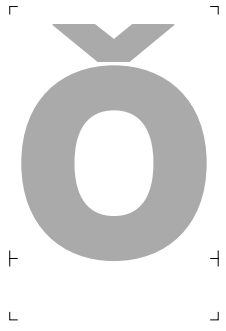

Ocaron 01D1

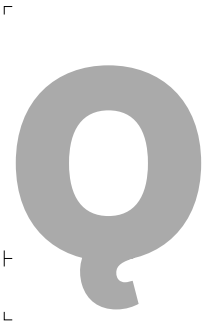

Oogonek 01EA

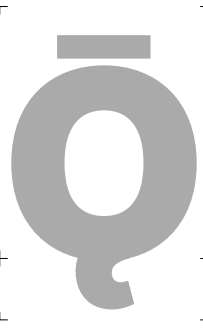

Oogonekmacron 01EC

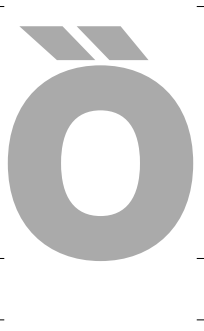

Odblgrave 020C

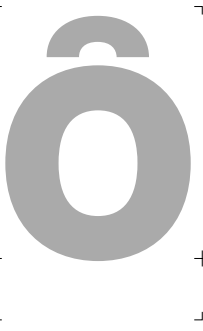

Oinvertedbreve 020E

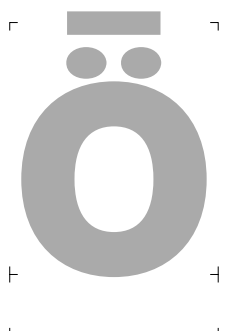

uni022A 022A

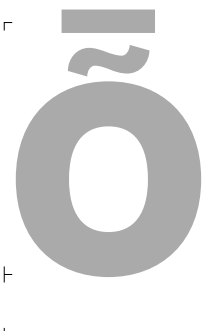

uni022C 022C

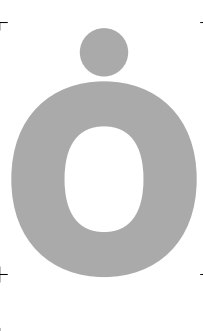

uni022E 022E

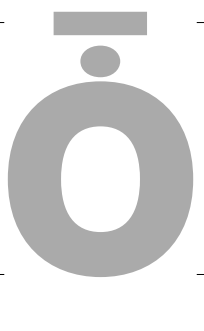

uni0230 0230

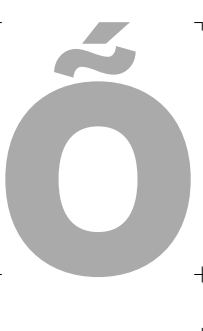

Otildeacute 1E4C

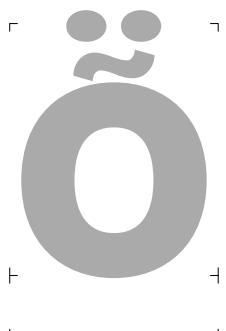

Otildedieresis 1E4E

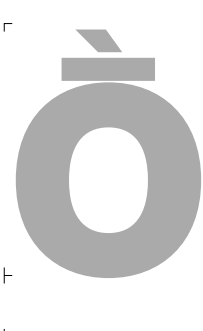

Omacrongrave 1E50

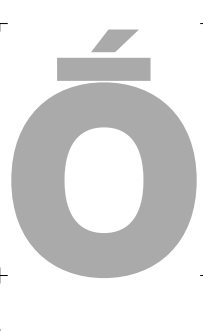

Omacronacute 1E52

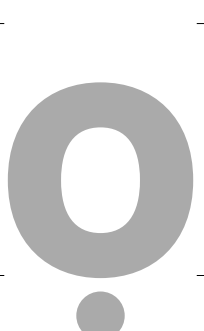

Odotbelow 1ECC

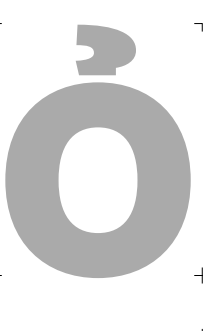

Ohookabove 1ECE

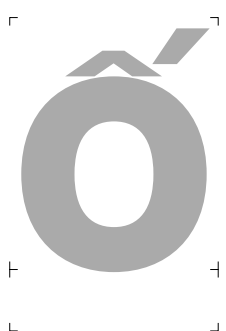

Ocircumflexacute 1ED0

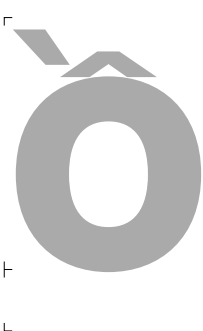

Ocircumflexgrave 1ED2



Ocircumflexhookabove 1ED4

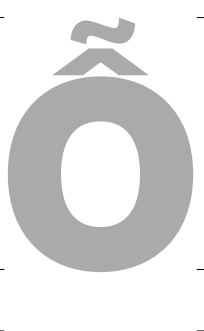

Ocircumflextilde 1ED6

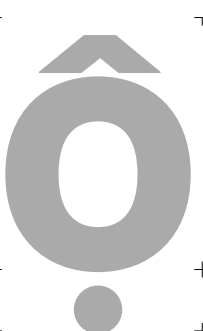

Ocircumflexdotbelow 1ED8

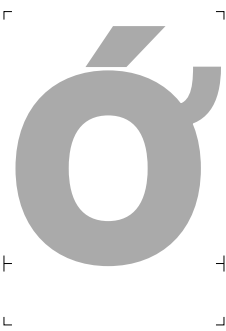

Ohornacute 1EDA



Ohorngrave 1EDC

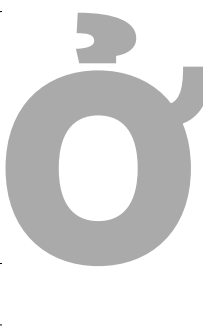

Ohornhookabove 1EDE



Ohorntilde 1EE0



Ohorndotbelow 1EE2

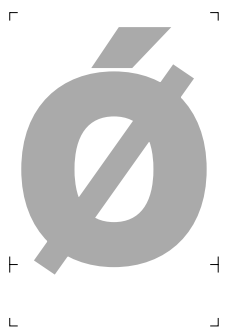

Oslashacute 01FE

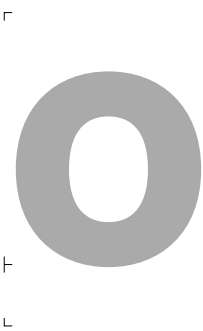

Omicron 039F



Omicrontonos 038C



uni1F48 1F48

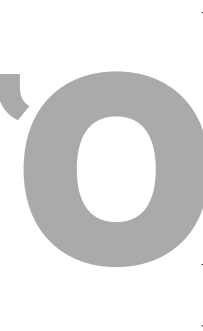

uni1F49 1F49

uni1F4A 1F4A uni1F4B 1F4B uni1F4C 1F4C uni1F4D 1F4D uni1FF8 1FF8

uni03F4 03F4 uni1FF9 1FF9 afii10032 041E Odieresiscyrillic 04E6 Obar 019F

Obarredcyrillic 04E8 Obarreddieresiscyrillic 04EA OE 0152 P 0050 Pacute 1E54

Pdotaccent 1E56 uni048E 048E Phook 01A4 Rho 03A1 uni1FEC 1FEC

Q 0051 R 0052 Racute 0154 Rcommaaccent 0156 Rcaron 0158

Rdblgrave 0210 Rinvertedbreve 0212 Rdotaccent 1E58 Rdotbelow 1E5A Rdotbelowmacron 1E5C

Rlinebelow 1E5E response 211F Rx 211E uni024C 024C S 0053



Sacute 015A



Scircumflex 015C



Scedilla 015E



Scaron 0160



Scommaaccent 0218



Sdotaccent 1E60



Sdotbelow 1E62



Sacutedotaccent 1E64



Scarondotaccent 1E66



Sdotbelowdotaccent 1E68



afii10054 0405



Tonetwo 01A7

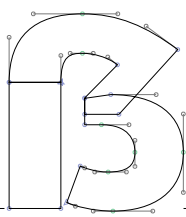

Germandbls 1E9E

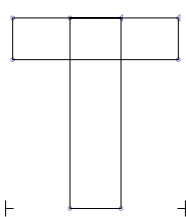

T 0054



Tcommaaccent 0162

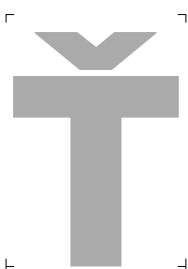

Tcaron 0164



uni021A 021A



Tdotaccent 1E6A



Tdotbelow 1E6C



Tlinebelow 1E6E



Tcircumflexbelow 1E70

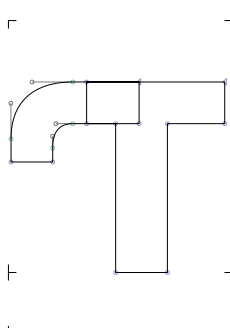

Thook 01AC

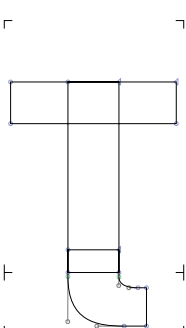

Trhook 01AE

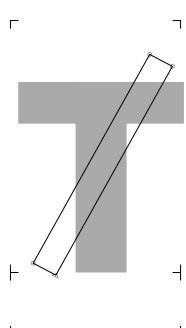

uni023E 023E



Tau 03A4

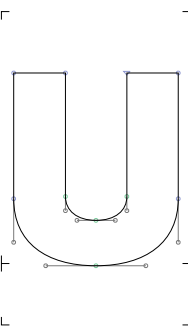

U 0055

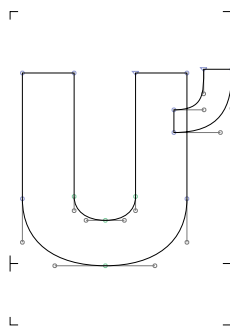

Uhorn 01AF



Ugrave 00D9



Uacute 00DA



Ucircumflex 00DB



Udieresis 00DC



Utilde 0168



Umacron 016A



Ubreve 016C

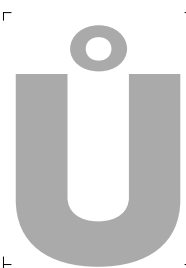

Uring 016E



Uhungarumlaut 0170



Uogonek 0172



Ucaron 01D3



Udieresismacron 01D5



Udieresisacute 01D7



Udieresiscaron 01D9



Udieresisgrave 01DB



Udblgrave 0214



Uinvertedbreve 0216



Udieresisbelow 1E72



Utildebelow 1E74



Ucircumflexbelow 1E76



Utildeacute 1E78



Umacrondieresis 1E7A



Udotbelow 1EE4



Uhookabove 1EE6



Uhornacute 1EE8



Uhorngrave 1EEA



Uhornhookabove 1EEC



Uhorntilde 1EEE



Uhorndotbelow 1EF0

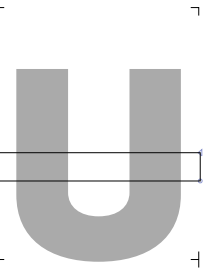

uni0244 0244

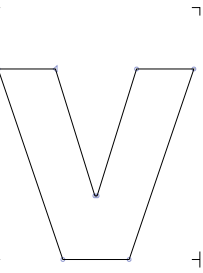

V 0056



Vtilde 1E7C



Vdotbelow 1E7E

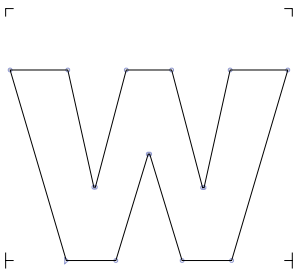

W 0057



Wcircumflex 0174



Wgrave 1E80



Wacute 1E82



Wdieresis 1E84



Wdotaccent 1E86



Wdotbelow 1E88

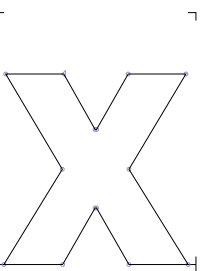

X 0058



Xdotaccent 1E8A



Xdieresis 1E8C

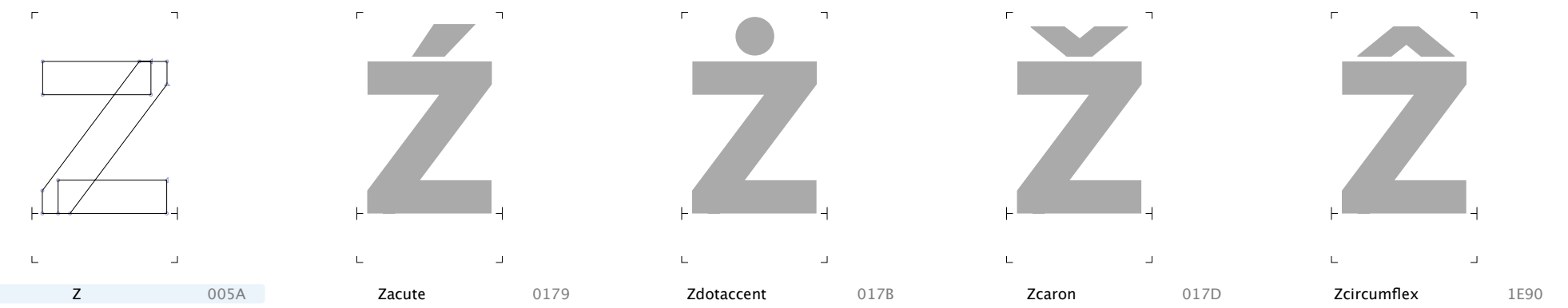
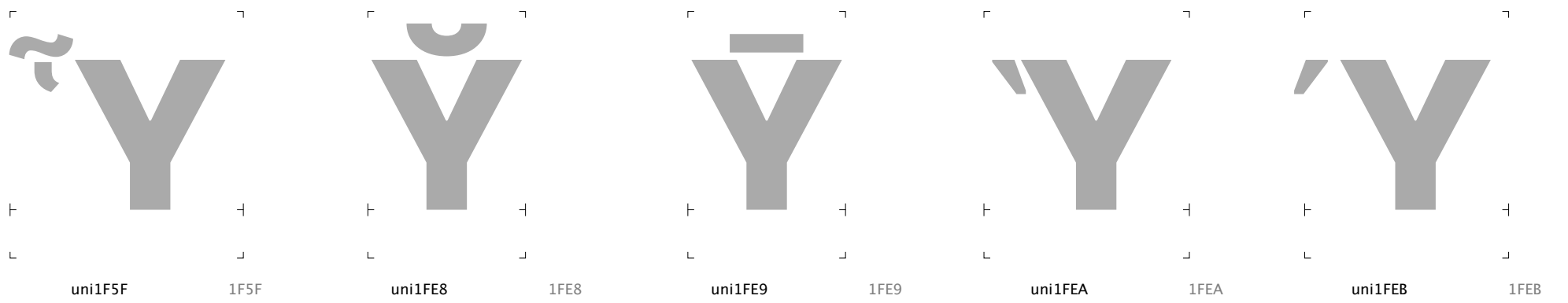
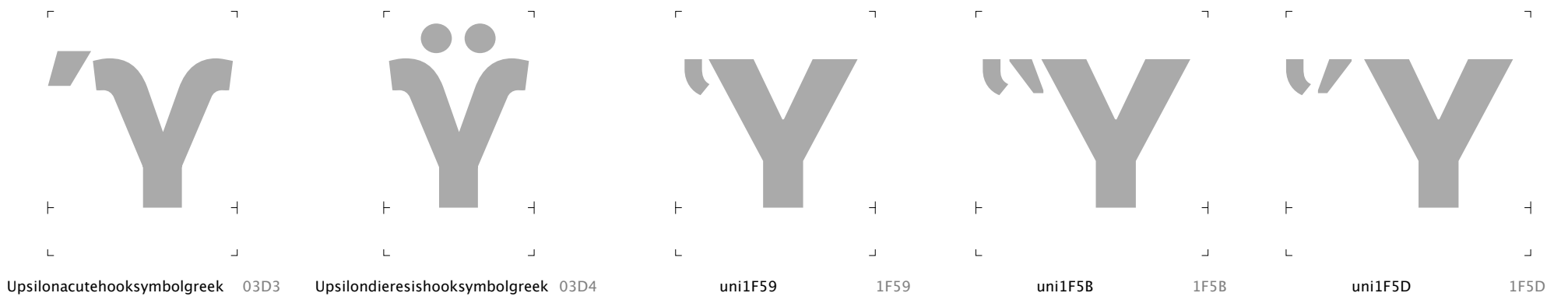
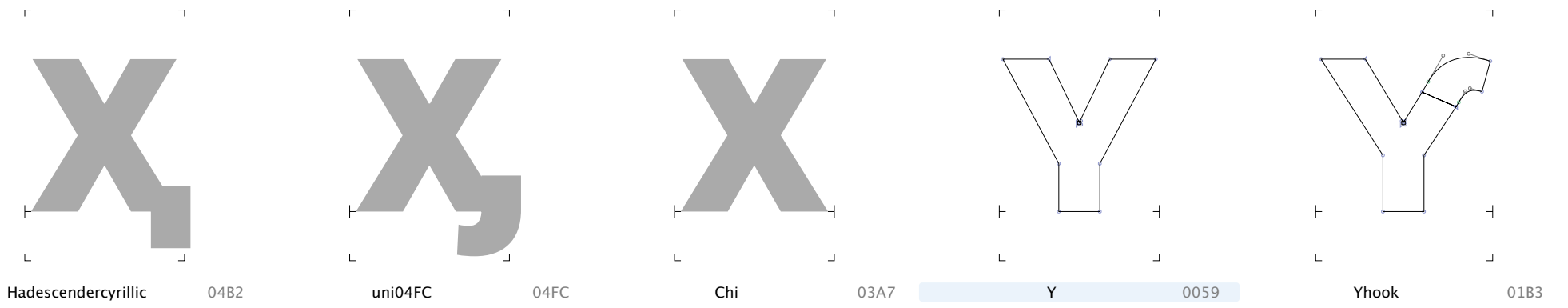

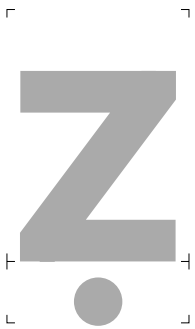

Zdotbelow 1E92



Zlinebelow 1E94

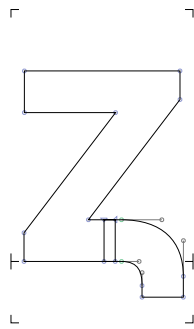

uni0224 0224

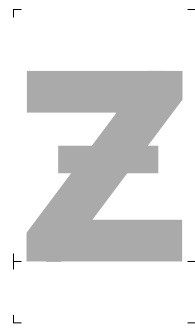

Zbar 01B5



Zeta 0396

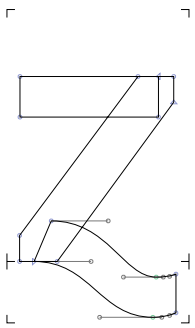

uni2C7F 2C7F

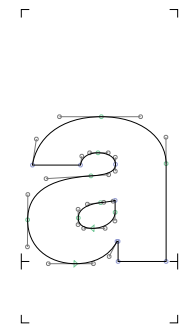

a 0061



adieresis 00E4



atilde 00E3



arighthalfring 1E9A



agrave 00E0



acute 00E1



acircumflex 00E2



aring 00E5



amacron 0101



abreve 0103



aogonek 0105



acaron 01CE



adieresismacron 01DF



adotmacron 01E1



aringacute 01FB



adblgrave 0201



ainvertedbreve 0203



uni0227 0227



aringbelow 1E01



adotbelow 1EA1



ahookabove 1EA3



acircumflexacute 1EA5



acircumflexgrave 1EA7



acircumflexhookabove 1EA9



acircumflextilde 1EAB



acircumflexdotbelow 1EAD



abreveacute 1EAF



abrevegrave 1EB1



abrevehookabove 1EB3



abrevetilde 1EB5



abrevedotbelow 1EB7

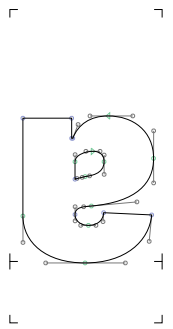

aturn 0250



afii10065 0430



abrevicyrillic 04D1



adieresiscyrillic 04D3

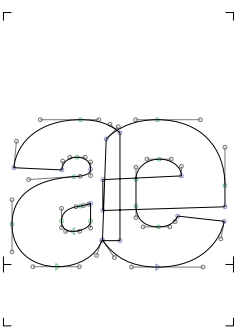

ae 00E6



aemacron 01E3



aeacute 01FD



aiecyrillic 04D5

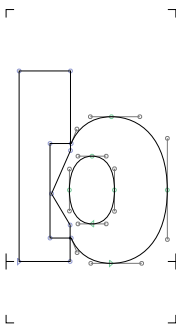

b 0062



bbar 0180

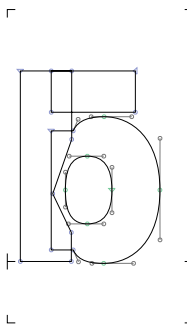

btopbar 0183

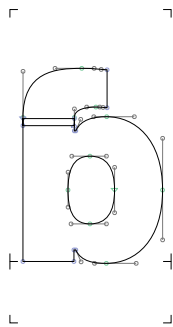

bhook 0253



bdotaccent 1E03



bdotbelow 1E05



blinebelow 1E07

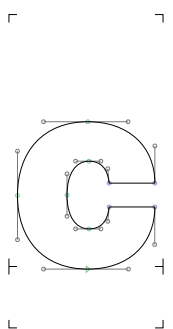

c 0063

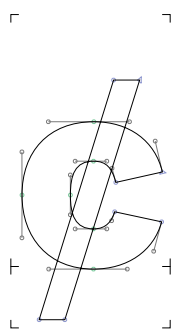

uni023C 023C

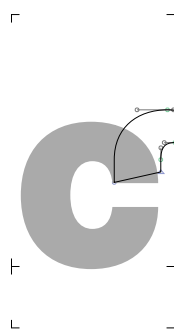

chook 0188

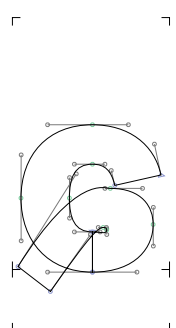

ccurl 0255



ccedilla 00E7



cacute 0107

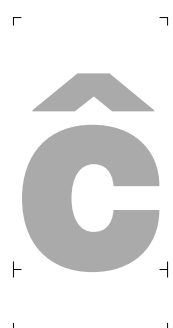

ccircumflex 0109

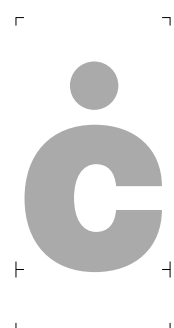

cdotaccent 010B



ccaron 010D



ccedillaacute 1E09



sigmalunatesymbolgreek 03F2



escyrillic 0441



d 0064



dcroat 0111

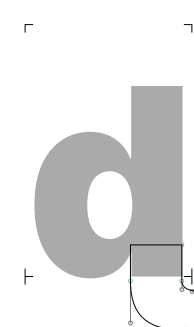

drthook 0256

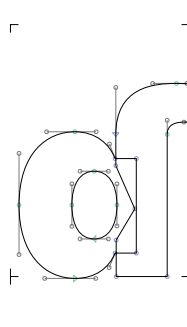

dhook 0257

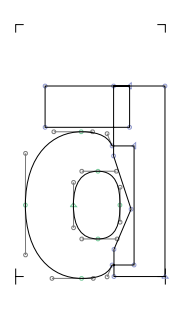

dtopbar 018C

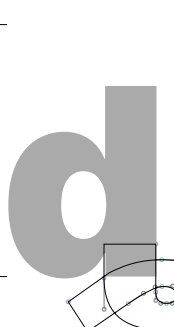

uni0221 0221

dcaron 010F	ddotaccent 1E0B	ddotbelow 1E0D	dlinebelow 1E0F	dcedilla 1E11
dcircumflexbelow 1E13	dz 02A3	dzcaron 01C6	dzcurl 02A5	dyogh 02A4
dong 20AB	e 0065	edieresis 00EB	uni0247 0247	egrave 00E8
eacute 00E9	ecircumflex 00EA	emacron 0113	ebreve 0115	edotaccent 0117
eogonek 0119	ecaron 011B	edblgrave 0205	einvertedbreve 0207	uni0229 0229
emacrongrave 1E15	emacronacute 1E17	ecircumflexbelow 1E19	etildebelow 1E1B	ecedillabreve 1E1D
edotbelow 1EB9	ehookabove 1EBB	etilde 1EBD	ecircumflexacute 1EBF	ecircumflexgrave 1EC1







uni021F

021F



hdotaccent

1E23



hdotbelow

1E25



hdieresis

1E27



hbrevebelow

1E2B



hlinebelow

1E96



shhacryillic

04BB



i

0069

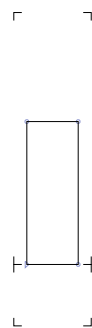

idotless

0131



idieresis

00EF



idieresisacute

1E2F



itilde

0129



itildebelow

1E2D



uni1E2D.ccmp



ibar

0268



igrave

00EC



iacute

00ED



icircumflex

00EE



imacron

012B



ibreve

012D



uni012F.ccmp



iogonek

012F



icaron

01D0



idblgrave

0209



iivertedbreve

020B



ihookabove

1EC9



idotbelow

1ECB



uni1ECB.ccmp

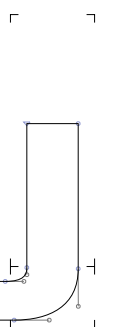

jdotless

0237



jdotlessbar

025F



uni0249

0249



uni0249.ccmp



icyrillic

0456



yicyrillic

0457



ij

0133



j

006A

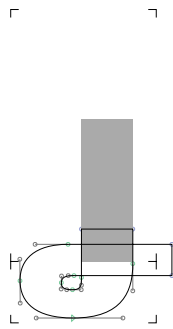

jcrosstail.ccmp



jcrosstail

029D



jcircumflex

0135



jcaron

01F0



yotgreek

03F3

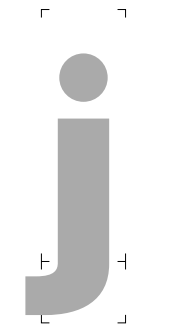

jecyrillic

0458



lj

01C9

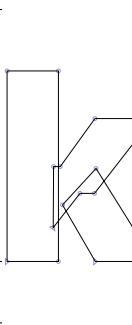

k

006B

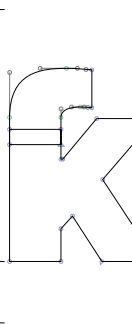

khook

0199



kcommaaccent

0137

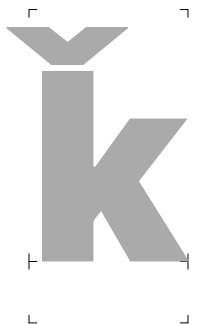

kcaron

01E9



kacute

1E31



kdotbelow

1E33



klinebelow

1E35

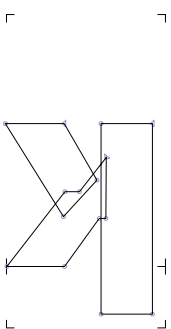

kturn

029E

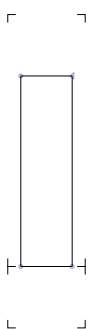

l

006C

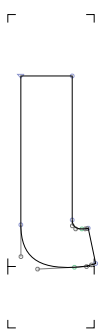

l.ss02

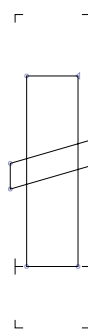

lslash

0142

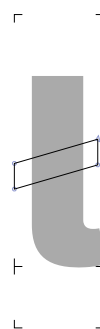

lslash.ss02



lbar

019A



lbar.ss02



lmidtilde

026B



lmidtilde.ss02

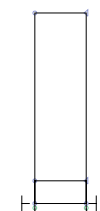

lrhook

026D

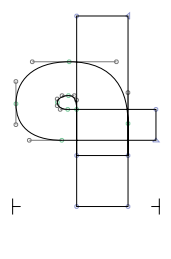

lbelt

026C

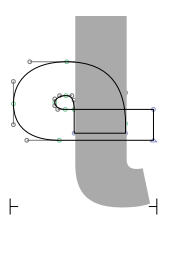

lbelt.ss02

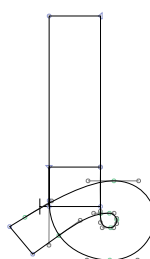

lcurl

0234



ldot

0140



ldot.ss02



lacute

013A



lacute.ss02



lcommaaccent

013C



lcommaaccent.ss02



lcaron

013E



lcaron.ss02



ldotbelow

1E37



ldotbelow.ss02



ldotbelowmacron

1E39



ldotbelowmacron.ss02



llinebelow

1E3B



llinebelow.ss02



lcircumflexbelow

1E3D



lcircumflexbelow.ss02

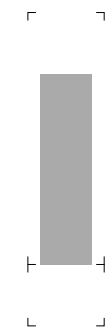

uni04CF

04CF

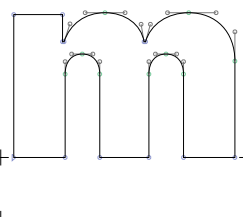

m

006D

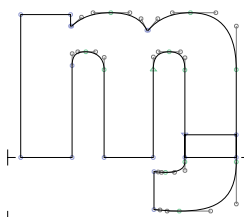

mhook

0271



mturn

026F



mturndescend

0270



macute

1E3F



mdotaccent

1E41



mdotbelow

1E43

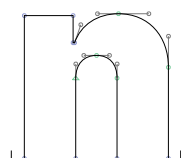

n

006E



ntilde

00F1

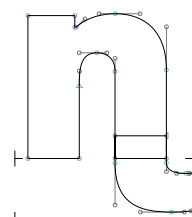

nrthook

0273

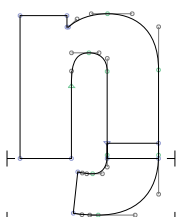

eng

014B

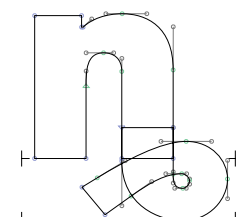

ncurl

0235

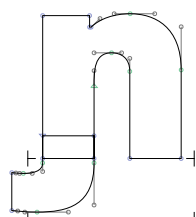

nlfthook

0272

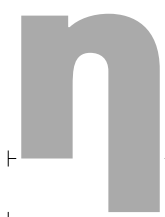

nlegrightlong

019E



nacute

0144



ncommaaccent

0146



ncaron

0148



uni01F9

01F9



ndotaccent

1E45



ndotbelow

1E47



nlinebelow

1E49



ncircumflexbelow

1E4B



nj

01CC

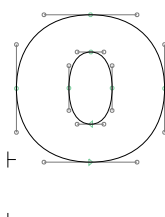

o

006F



odieresis

00F6

otilde 00F5	oslash 00F8	ohorn 01A1	ograve 00F2	oacute 00F3
ocircumflex 00F4	omacron 014D	obreve 014F	ohungarumlaut 0151	ocaron 01D2
oogonek 01EB	oogonekmacron 01ED	odblgrave 020D	oinvertedbreve 020F	uni022B 022B
uni022D 022D	uni022F 022F	uni0231 0231	otildeacute 1E4D	otildedieresis 1E4F
omacrongrave 1E51	omacronacute 1E53	odotbelow 1ECD	ohookabove 1ECF	ocircumflexacute 1ED1
ocircumflexgrave 1ED3	ocircumflexhookabove 1ED5	ocircumflextilde 1ED7	ocircumflexdotbelow 1ED9	ohornacute 1EDB
ohorngrave 1EDD	ohornhookabove 1EDF	ohorntilde 1EE1	ohorndotbelow 1EE3	oslashacute 01FF

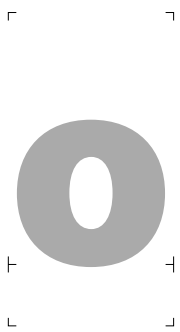

omicron 03BF



omicrontonos 03CC



uni1F40 1F40



uni1F41 1F41

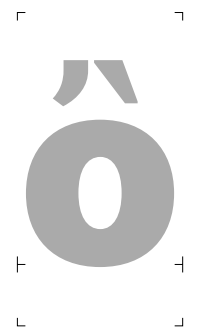

uni1F42 1F42

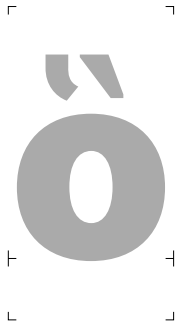

uni1F43 1F43



uni1F44 1F44

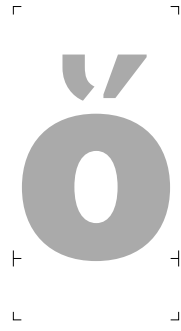

uni1F45 1F45



uni1F78 1F78

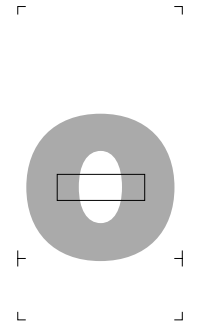

fitacyrillic 0473



obar 0275

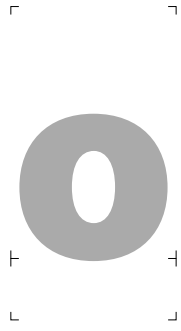

ocyrllic 043E

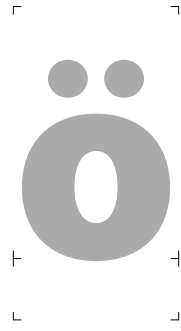

odieresiscyrillic 04E7



oe 0153



ukcyrillic 0479

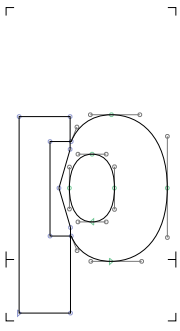

p 0070

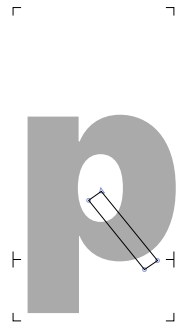

uni048F 048F

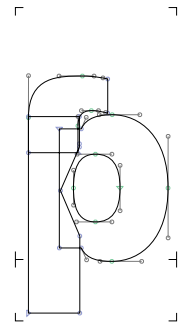

phook 01A5



pacute 1E55

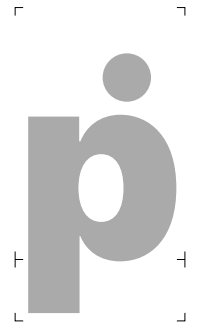

pdotaccent 1E57



ercyrillic 0440



q 0071

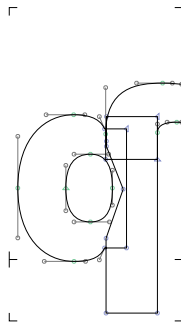

qhook 02A0

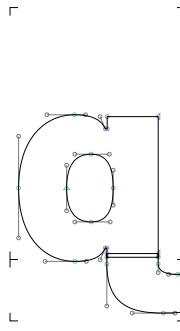

qrhook 024B

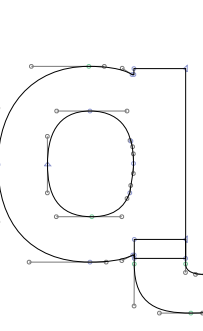

Q\_rhook 024A

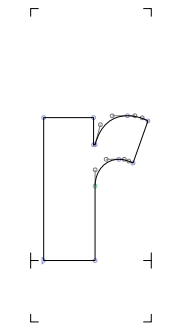

r 0072



rrhook 027D



uni024D 024D

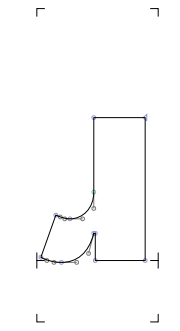

rturn 0279

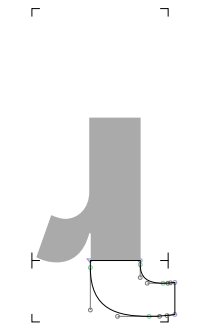

rturnrhook 027B



rfishhookrev 027F

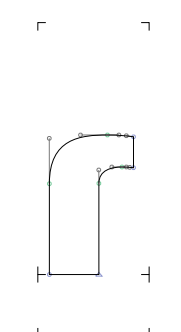

rfishhook 027E



rdescend 027C



racute 0155



rcommaaccent 0157



rcaron

0159



rdblgrave

0211



rinvetdbreve

0213



rđotaccent

1E59



rđotbelow

1E5B



rđotbelowmacron

1E5D



rlinebelow

1E5F

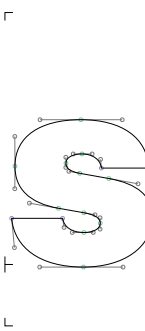

s

0073

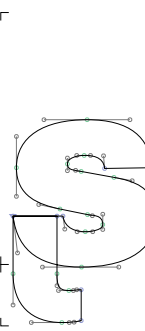

srthook

0282



uni023F

023F



sacute

015B



scircumflex

015D



scedilla

015F



scaron

0161



scommaaccent

0219



sđotaccent

1E61



sđotbelow

1E63



sacuteđotaccent

1E65



scaronđotaccent

1E67



sđotbelowđotaccent

1E69



dzecyrillic

0455



tonetwo

01A8

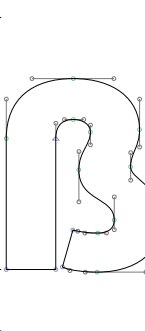

germandbls

00DF

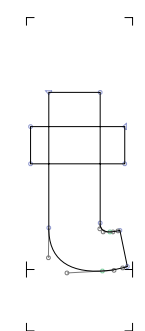

t

0074

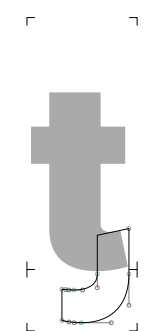

tpatalhook

01AB

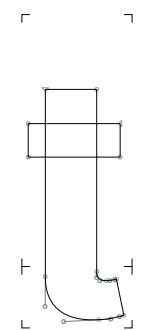

trthook

0288

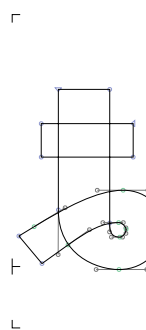

tcurl

0236

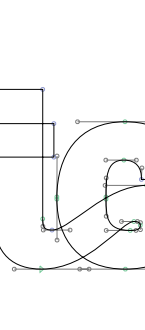

tccurl

02A8



tturn

0287

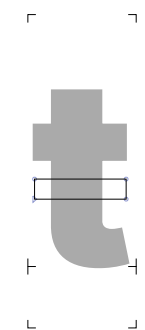

tbar

0167



tcommaaccent

0163



tcaron

0165



uni021B

021B



tđotaccent

1E6B



tđotbelow

1E6D

tlinebelow 1E6F	tcircumflexbelow 1E71	tdieresis 1E97	u 0075	udieresis 00FC
utilde 0169	uhorn 01B0	micro 00B5	ubar 0289	ugrave 00F9
uacute 00FA	ucircumflex 00FB	umacron 016B	ubreve 016D	uring 016F
uhungarumlaut 0171	uogonek 0173	ucaron 01D4	udieresismacron 01D6	udieresisacute 01D8
udieresiscaron 01DA	udieresisgrave 01DC	udblgrave 0215	uinvertedbreve 0217	udieresisbelow 1E73
utildebelow 1E75	ucircumflexbelow 1E77	utildeacute 1E79	umacrondieresis 1E7B	udotbelow 1EE5
uhookabove 1EE7	uhornacute 1EE9	uhorngrave 1EEB	uhornhookabove 1EED	uhorntilde 1EEF



uhorndotbelow 1EF1 **v** 0076 vturn 028C vtilde 1E7D vdotbelow 1E7F

**w** 0077 wdieresis 1E85 wturn 028D wcircumflex 0175 wgrave 1E81

wacute 1E83 wdotaccent 1E87 wdotbelow 1E89 wring 1E98 **x** 0078

xdotaccent 1E8B xdieresis 1E8D khacyrillic 0445 **y** 0079 ydieresis 00FF

yhook 01B4 uni024F 024F yacute 00FD ycircumflex 0177 uni0233 0233

ydotaccent 1E8F yring 1E99 ygrave 1EF3 ydotbelow 1EF5 yhookabove 1EF7

ytilde 1EF9 ucyrillic 0443 ushortcyrillic 045E umacroncyrillic 04EF udieresiscyrillic 04F1

uhungarumlautcyrillic 04F3	yturn 028E	<b>z 007A</b>	zbar 01B6	zhook 0225

uni0240 0240	zrthook 0290	zacute 017A	zdotaccent 017C	zcaron 017E

zcircumflex 1E91	zdotbelow 1E93	zlinebelow 1E95	zcurl 0291	Thorn 00DE

Gamma 0393	Delta 0394	Theta 0398	Xi 039E	Pi 03A0

Sigma 03A3	Phi 03A6	Psi 03A8	Omega 03A9	uni1FFB 1FFB

Omegatonos 038F	uni1F68 1F68	uni1F69 1F69	uni1F6A 1F6A	uni1F6B 1F6B

uni1F6C 1F6C	uni1F6D 1F6D	uni1F6E 1F6E	uni1F6F 1F6F	uni1FFA 1FFA

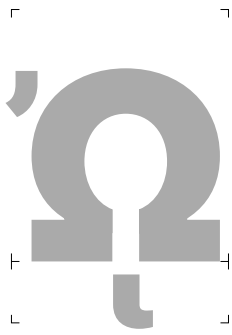

uni1FA8 1FA8

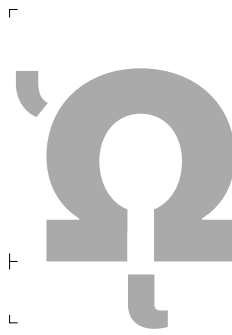

uni1FA9 1FA9

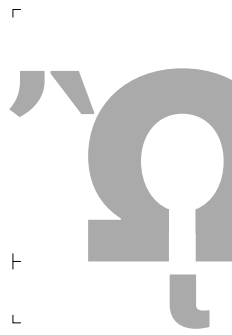

uni1FAA 1FAA

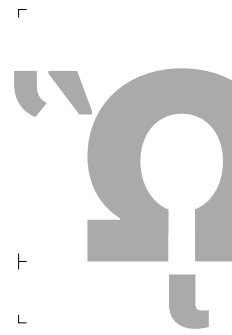

uni1FAB 1FAB



uni1FAC 1FAC

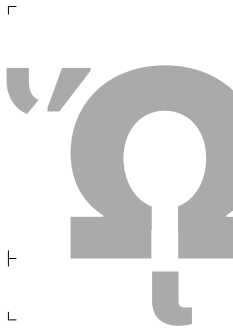

uni1FAD 1FAD

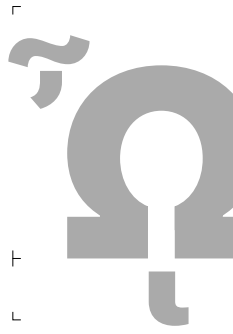

uni1FAE 1FAE

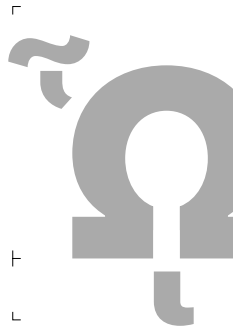

uni1FAF 1FAF

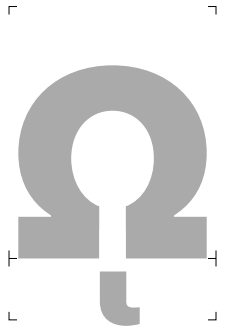

uni1FFC 1FFC

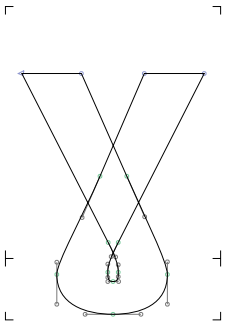

Gamma1 0194



afii10018 0411

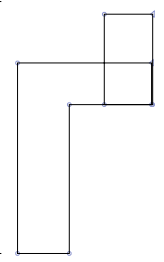

afii10050 0490

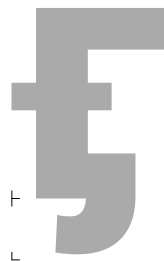

uni04FA 04FA

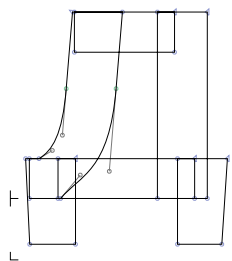

afii10021 0414

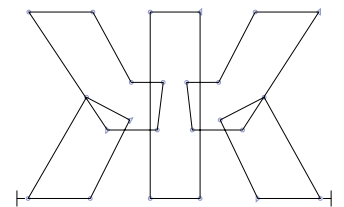

afii10024 0416



Zhedescendercyrillic 0496

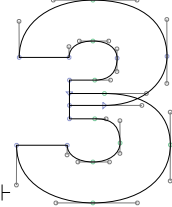

afii10025 0417

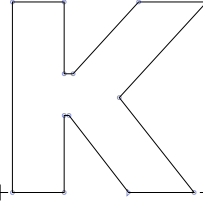

Kacyr 041A

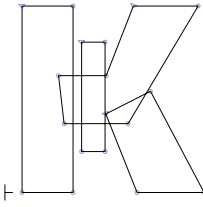

Kavertikalstrokeyrillic 049C

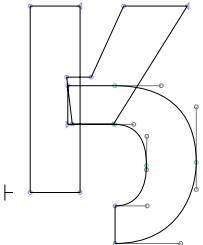

Kahookcyrillic 04C3

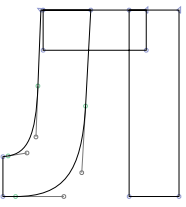

afii10029 041B

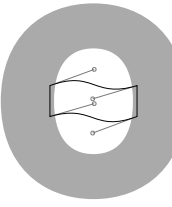

afii10147 0472

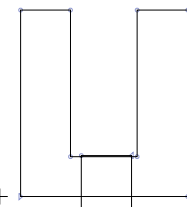

afii10145 040F

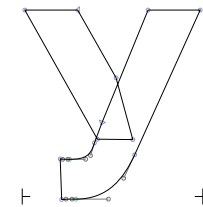

afii10037 0423

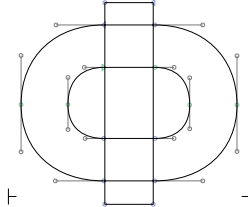

afii10038 0424

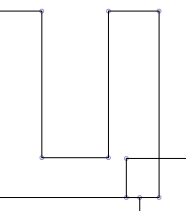

afii10040 0426

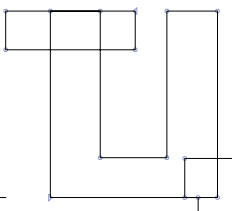

Tetsecyrillic 04B4

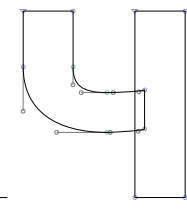

afii10041 0427



Chedescendercyrillic 04B6

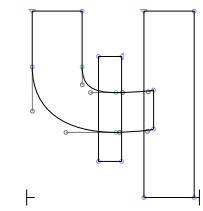

Cheverticalstrokeyrillic 04B8

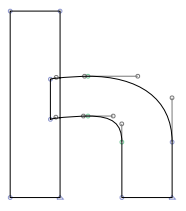

Shhacyrillic 04BA

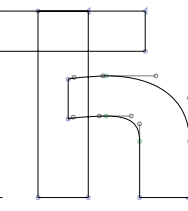

afii10060 040B

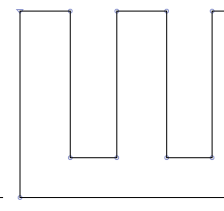

afii10042 0428

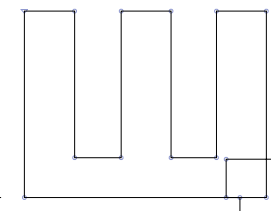

afii10043 0429

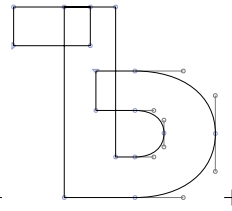

afii10044 042A

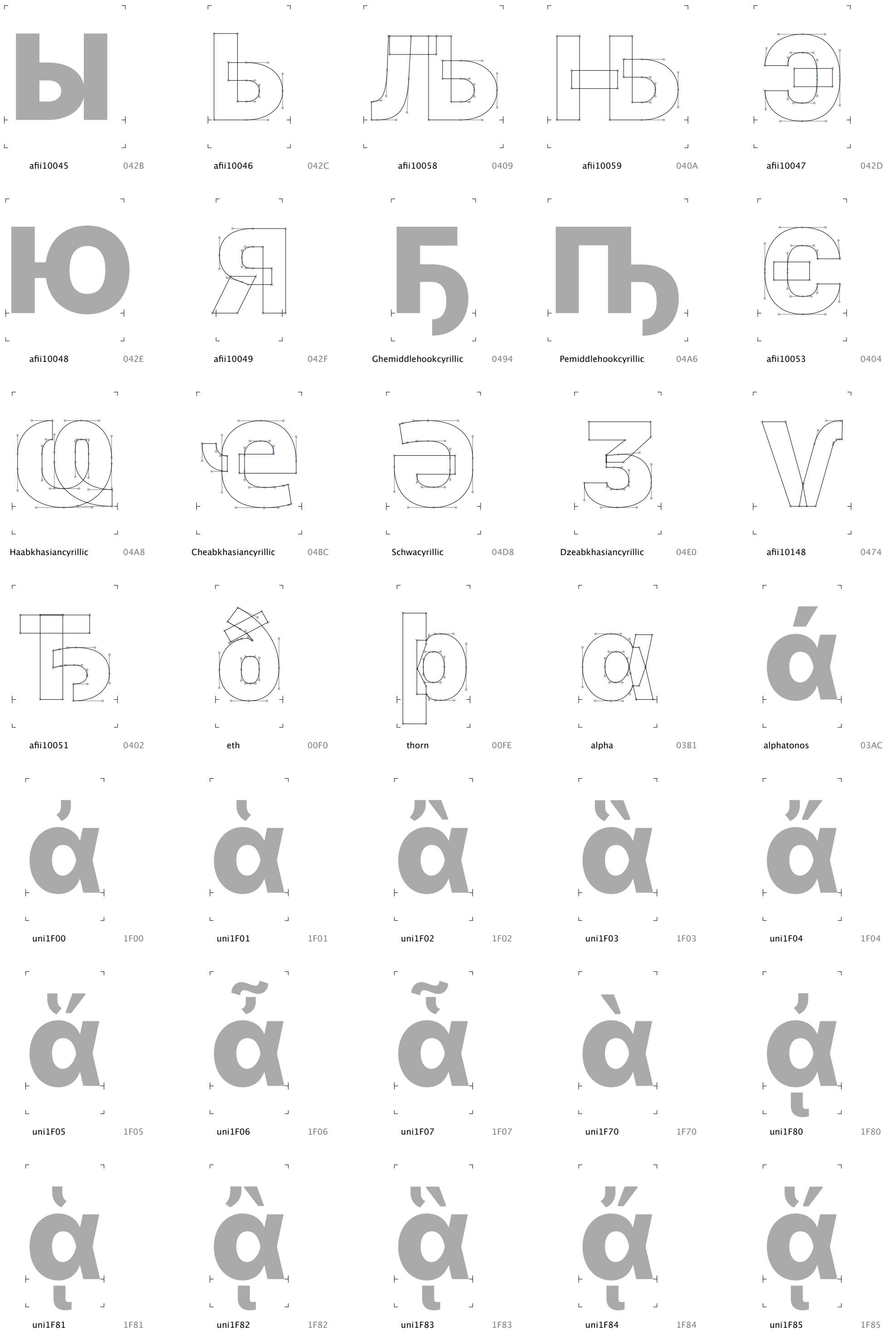



uni1F86 1F86



uni1F87 1F87



uni1FB0 1FB0



uni1FB1 1FB1



uni1FB2 1FB2



uni1FB3 1FB3



uni1FB4 1FB4



uni1FB6 1FB6



uni1FB7 1FB7

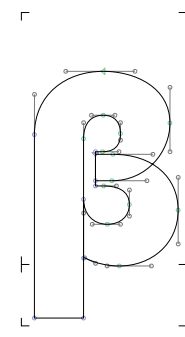

beta 03B2

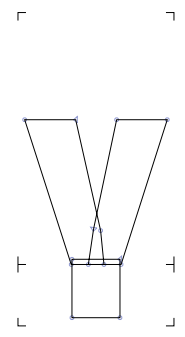

gamma 03B3

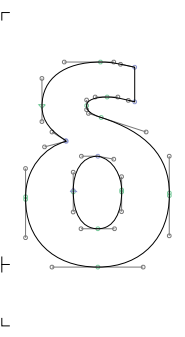

delta 03B4

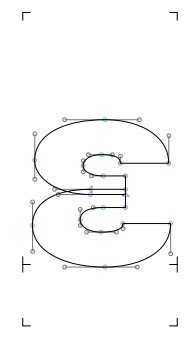

epsilon 03B5



epsilon 03AD

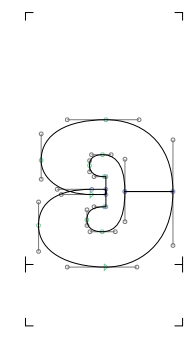

epsilonclosed 029A



epsilon1 025B



epsilon1rev 025C



epsilon1revclosed 025E

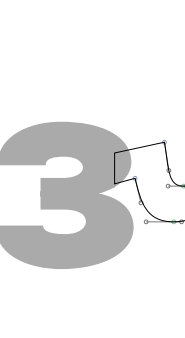

epsilon1revhook 025D



uni1F10 1F10



uni1F11 1F11



uni1F12 1F12



uni1F13 1F13



uni1F14 1F14



uni1F15 1F15



uni1F72 1F72

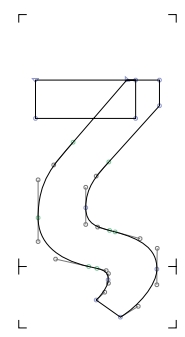

zeta 03B6

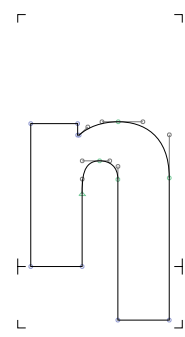

eta 03B7



etatonos 03AE



uni1F20 1F20



uni1F21 1F21



uni1F22 1F22



uni1F23 1F23



uni1F24 1F24



uni1F25 1F25



uni1F26

1F26



uni1F27

1F27



uni1F74

1F74



uni1F90

1F90



uni1F91

1F91



uni1F92

1F92



uni1F93

1F93



uni1F94

1F94



uni1F95

1F95



uni1F96

1F96



uni1F97

1F97



uni1FC2

1FC2



uni1FC3

1FC3



uni1FC4

1FC4



uni1FC6

1FC6



uni1FC7

1FC7

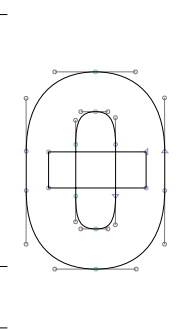

theta

03B8

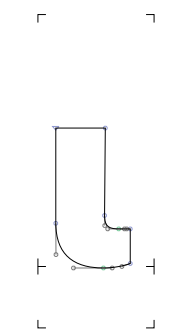

iota

03B9



iotadiesistonos

0390



iotatonos

03AF



iotadiesis

03CA

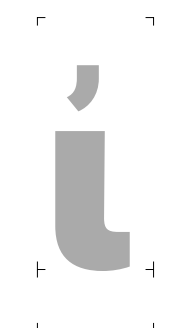

uni1F30

1F30

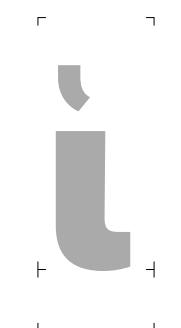

uni1F31

1F31



uni1F32

1F32



uni1F33

1F33



uni1F34

1F34

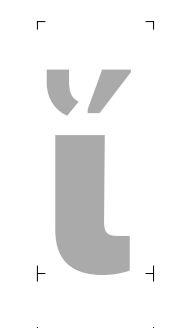

uni1F35

1F35

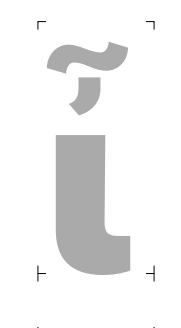

uni1F36

1F36

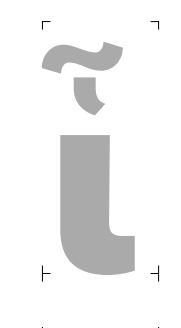

uni1F37

1F37

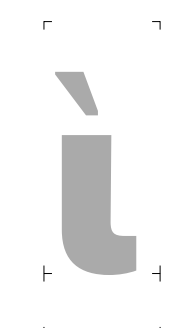

uni1F76

1F76

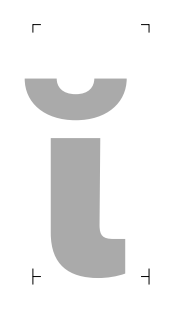

uni1FD0

1FD0



uni1FD1

1FD1



uni1FD2

1FD2



uni1FD6

1FD6



uni1FD7

1FD7

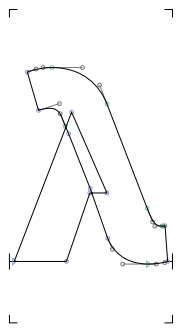

lambda

03BB

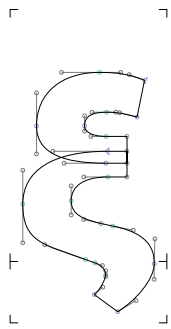

xi

03BE

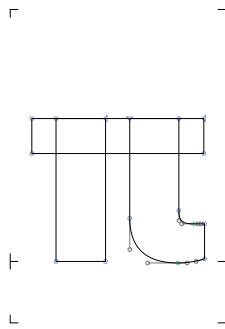

pi

03C0

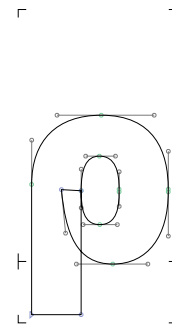

rho

03C1

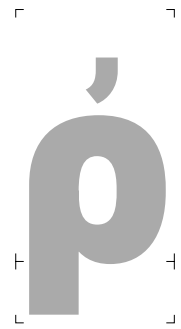

uni1FE4

1FE4



uni1FE5

1FE5



uni03FC

03FC

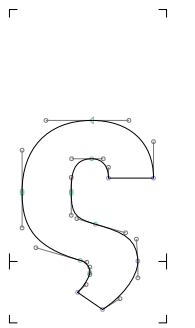

sigma1

03C2

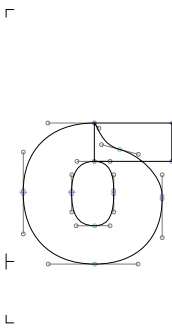

sigma

03C3

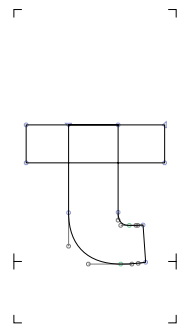

tau

03C4

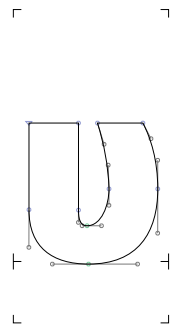

upsilon

03C5



upsilondieresistonos

03B0

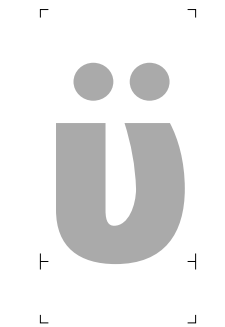

upsilondieresis

03CB



upsilontonos

03CD



uni1F50

1F50



uni1F51

1F51

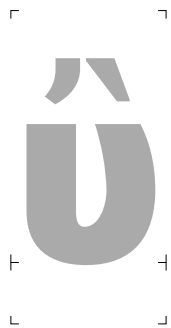

uni1F52

1F52

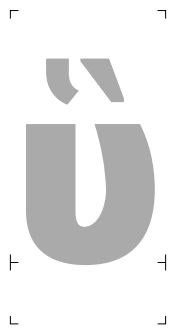

uni1F53

1F53



uni1F54

1F54



uni1F55

1F55



uni1F56

1F56



uni1F57

1F57

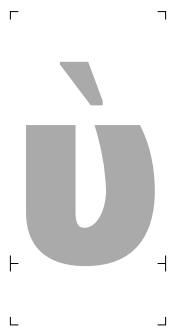

uni1F7A

1F7A



uni1FE0

1FE0



uni1FE1

1FE1



uni1FE2

1FE2



uni1FE6

1FE6



uni1FE7

1FE7

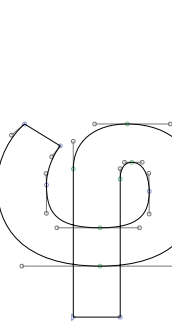

phi

03C6

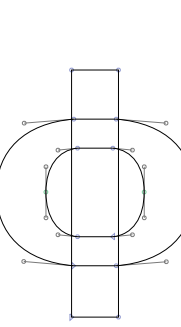

phigreek

03D5

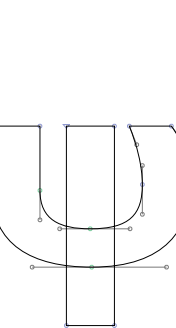

psi

03C8

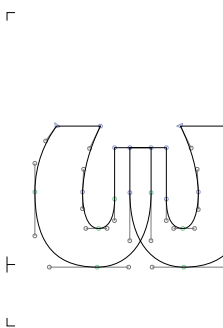

omega

03C9



omegatonos

03CE



uni1F60

1F60



uni1F61

1F61

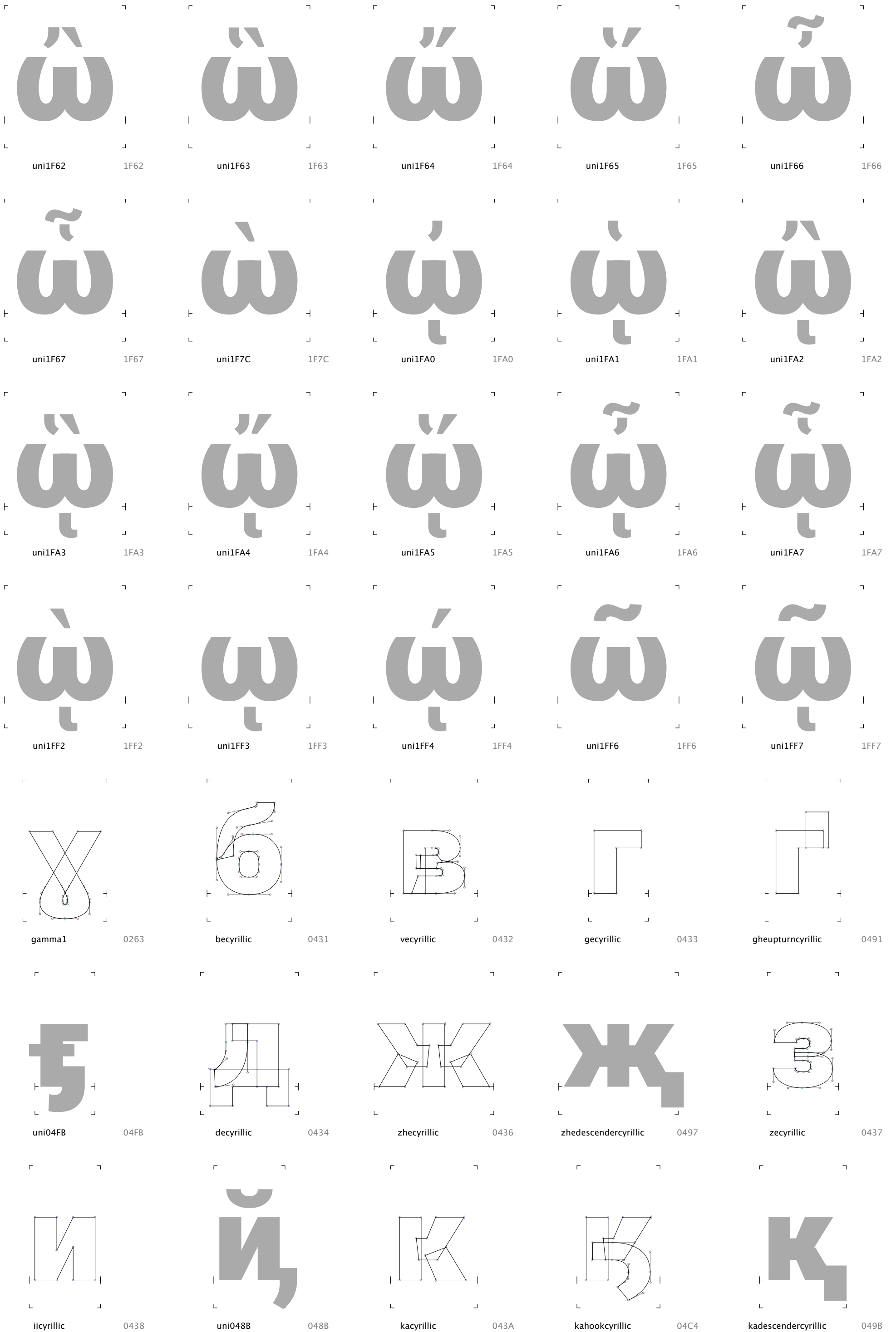



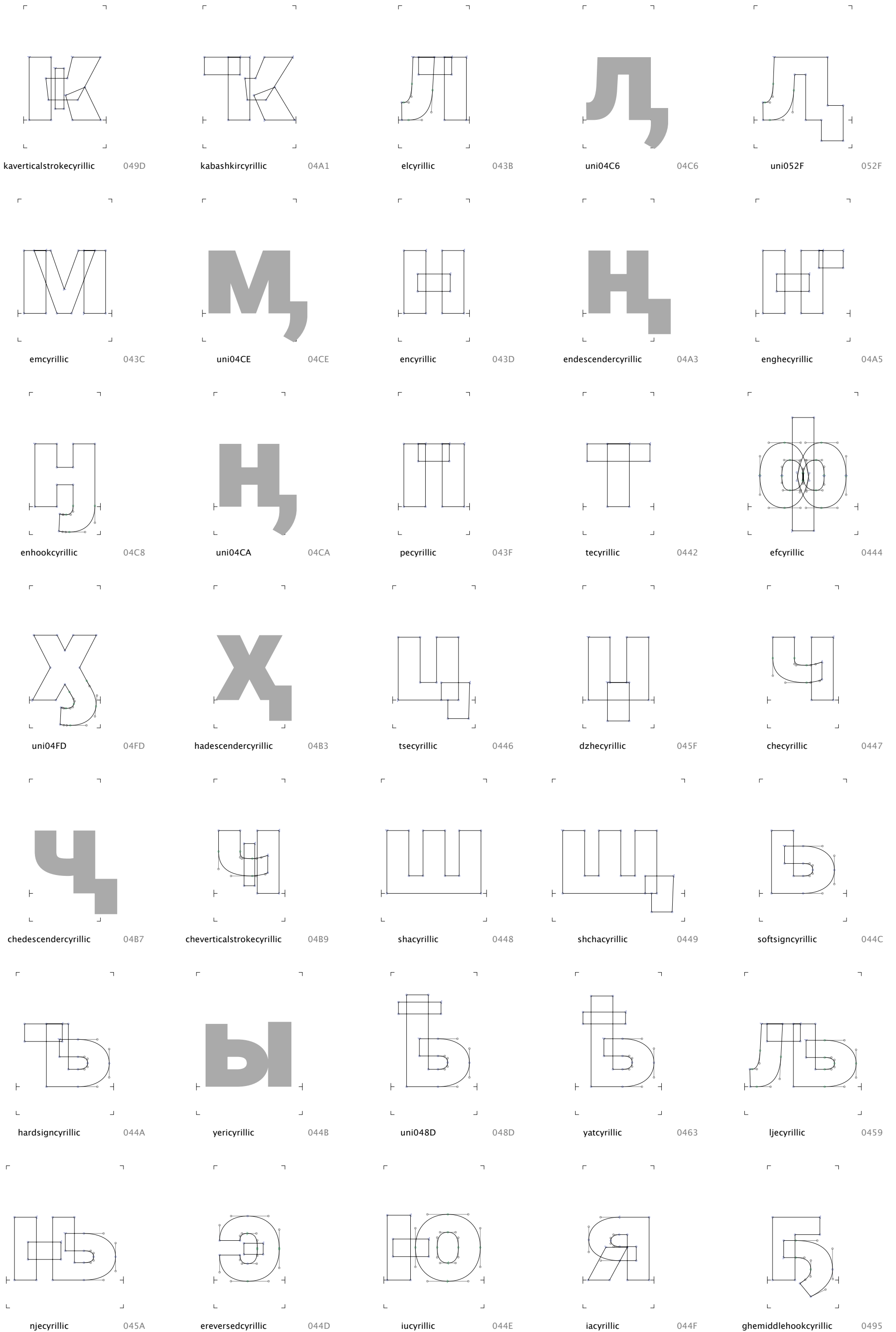

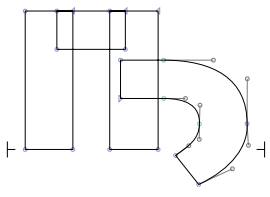

pemiddlehookcyrillic 04A7

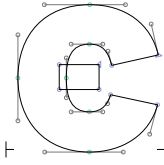

ecyrillic 0454

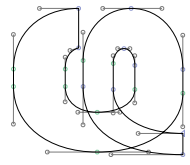

haabkhasiancyrillic 04A9

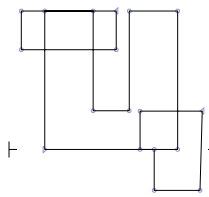

tetsecyrillic 04B5

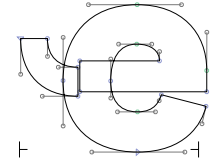

cheabkhasiancyrillic 04BD

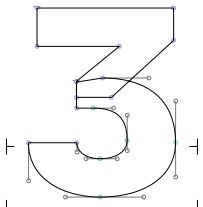

dzeabkhasiancyrillic 04E1

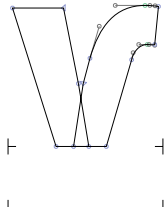

izhitsacyrillic 0475



dollar 0024

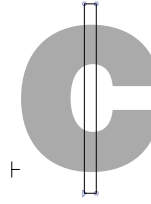

cent 00A2

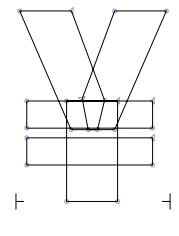

yen 00A5

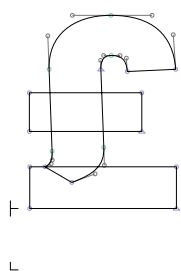

sterling 00A3

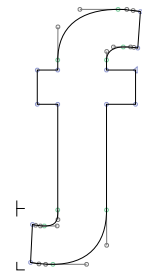

florin 0192

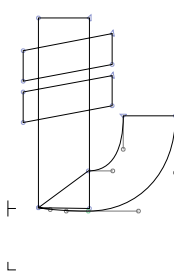

uni20BA 20BA

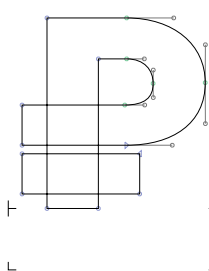

uni20BD 20BD

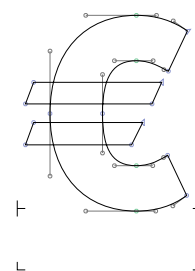

euro 20AC

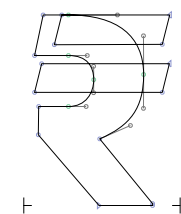

uni20B9 20B9

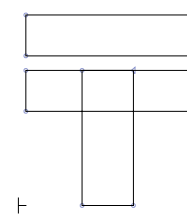

tenge 20B8

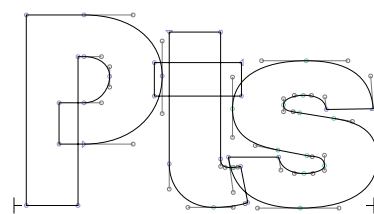

peseta 20A7

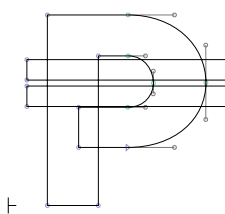

peso 20B1

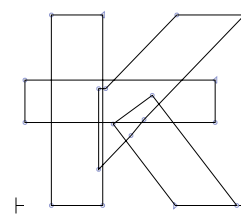

kip 20AD

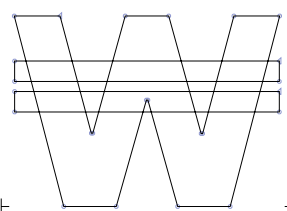

won 20A9

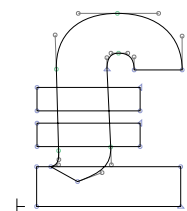

lira 20A4

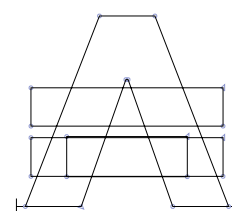

austral 20B3

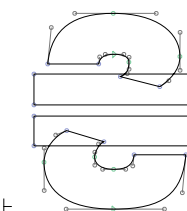

hryvnia 20B4

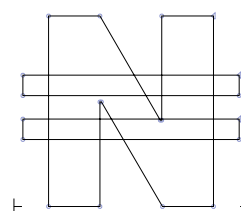

naira 20A6

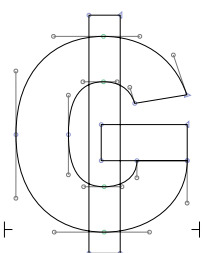

guarani 20B2

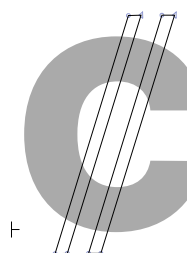

coloncurrencia 20A1

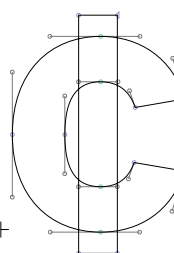

cedi 20B5

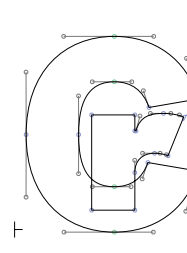

cruzeiro 20A2

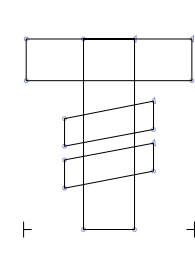

tugrik 20AE

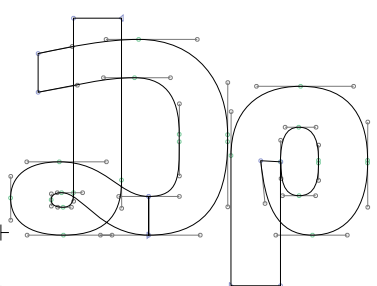

uni20AF 20AF

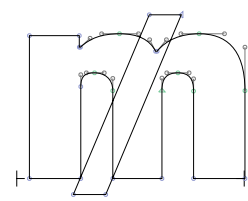

mill 20A5

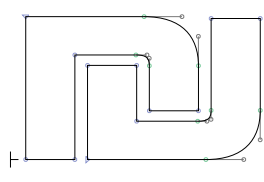

afi57636 20AA

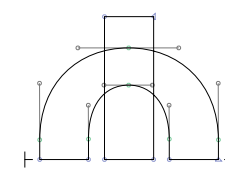

manat 20BC



rupee 20A8

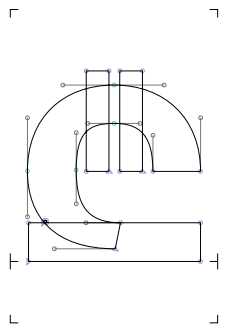

lari 20BE

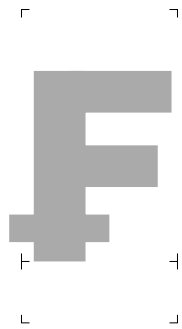

franc 20A3

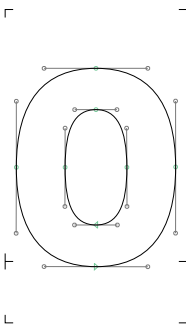

zero 0030

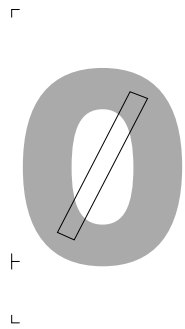

zero.slash

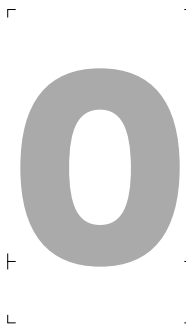

zero.tf



zero.tf.slash

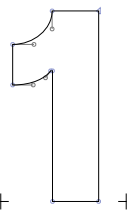

one 0031

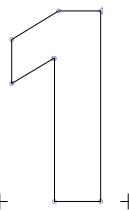

one.ss01



one.tf

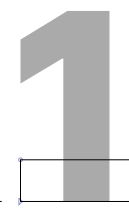

one.tf.ss01

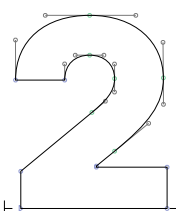

two 0032



two.tf



twostroke 01BB

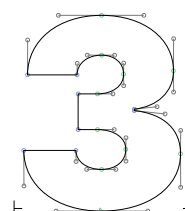

three 0033



three.tf

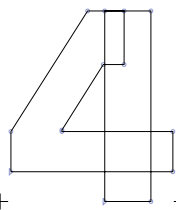

four 0034

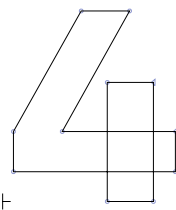

four.ss01



four.tf



four.tf.ss01

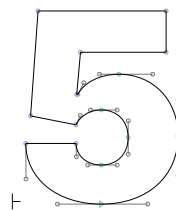

five 0035



five.tf

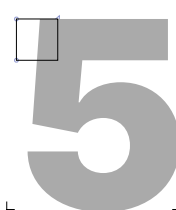

Tonefive 01BC

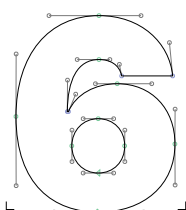

six 0036

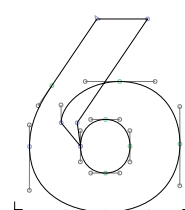

six.ss01



six.tf



six.tf.ss01

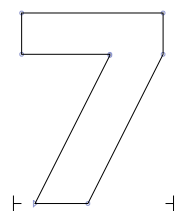

seven 0037



seven.tf

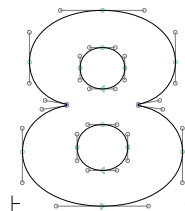

eight 0038



eight.tf

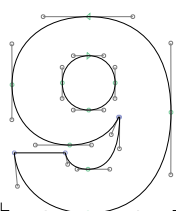

nine 0039

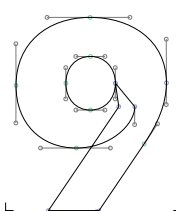

nine.ss01



nine.tf



nine.tf.ss01

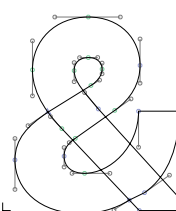

ampersand 0026

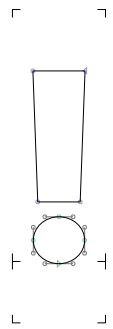

exclam 0021

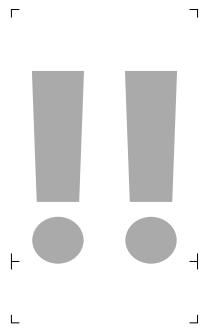

exclamdbl 203C



exclamdown 00A1

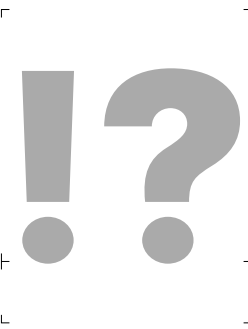

uni2049 2049

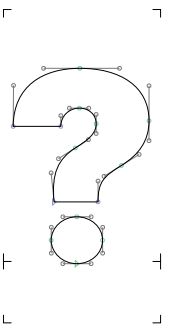

question 003F



uni2047 2047

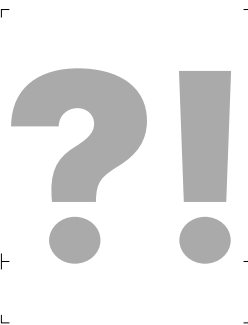

uni2048 2048



questiondown 00BF

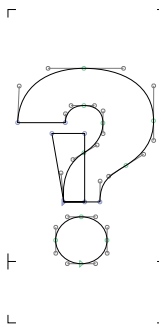

interrobang 203D



invertedinterrobang 2E18

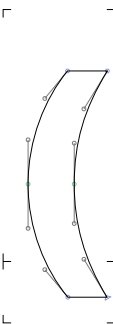

parenleft 0028



parenleft.case

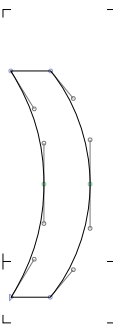

parenright 0029



parenright.case



bracketleft 005B



bracketleft.case

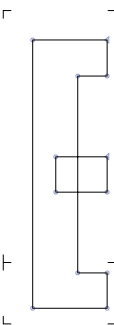

bracketleft\_quill 2045

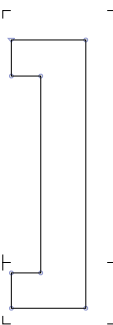

bracketright 005D



bracketright.case

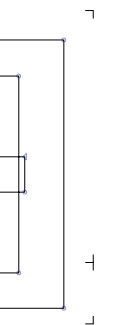

bracketright\_quill 2046

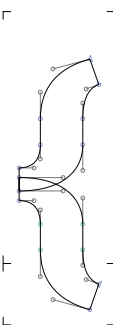

braceleft 007B



braceleft.case

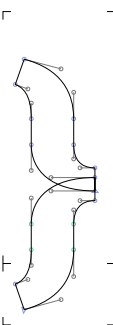

braceright 007D



braceright.case

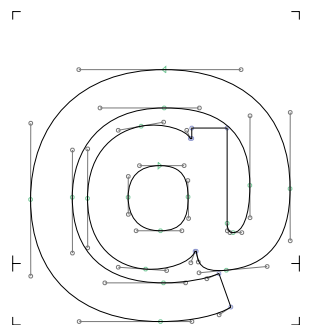

at 0040



at.case

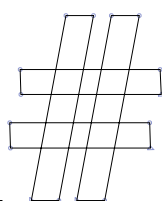

numbersign 0023

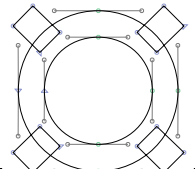

currency 00A4

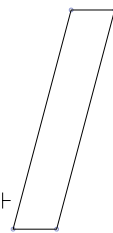

slash 002F



bar 007C

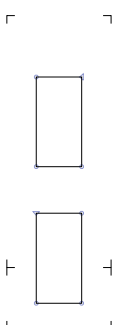

brokenbar 00A6

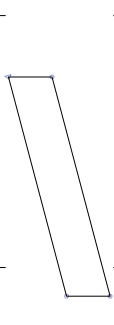

backslash 005C

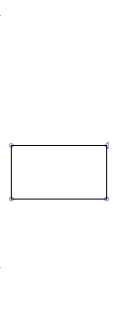



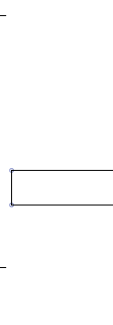





















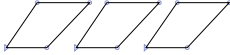









hyphenbullet 2043



hyphen 002D



softhyphen 00AD

				
hyphen.case	endash 2013	endash.case	figuredash 2012	figuredash.case
				
emdash 2014	emdash.case	horizontalbar 2015	bullet 2022	bullet.case
				
openbullet 25E6	openbullet.case	quoteleft 2018	quoteright 2019	apostrophemod 02BC
				
primetripl 2034	quotesingle 0027	minute 2032	quotedbl 0022	second 2033
				
quotedblleft 201C	quotedblright 201D	quotedblbase 201E	quotingslbase 201A	comma 002C
				
comma.tf	period 002E	period.tf	ellipsis 2026	twodotleader 2025
				
colon 003A	colon.case	colon.tf	semicolon 003B	semicolon.tf

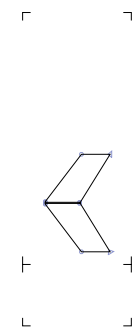

guilsingleft 2039

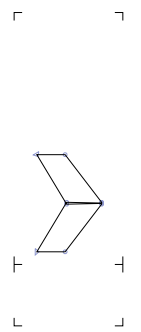

guilsingright 203A



guillemetleft 00AB



guillemetright 00BB

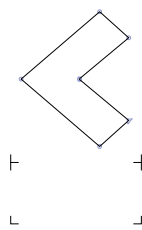

less 003C

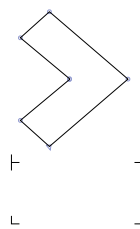

greater 003E

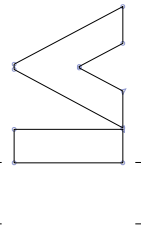

lessequal 2264

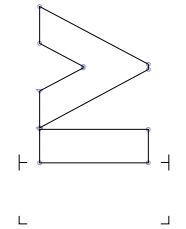

greaterequal 2265

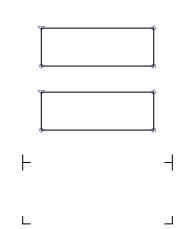

equal 003D



equal.case

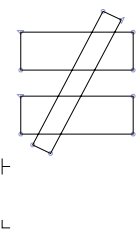

notequal 2260



notequal.case

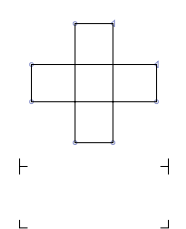

plus 002B

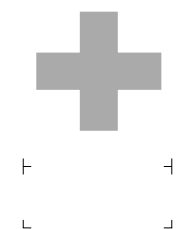

plus.case

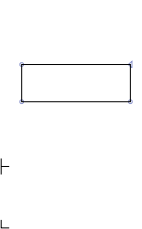

minus 2212



minus.case

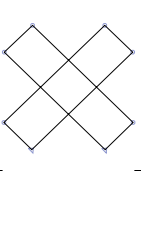

multiply 00D7

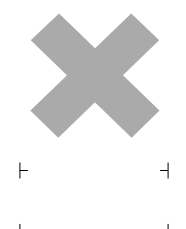

multiply.case

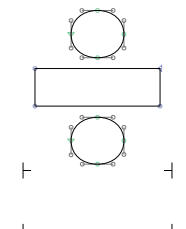

divide 00F7

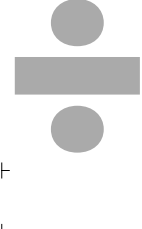

divide.case

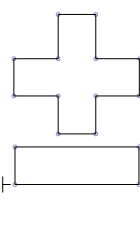

plusminus 00B1



plusminus.case

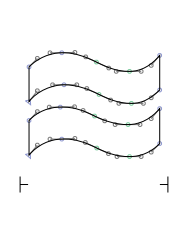

approxequal 2248

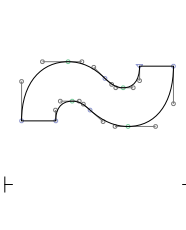

asciitilde 007E

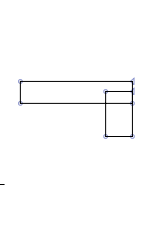

logicalnot 00AC

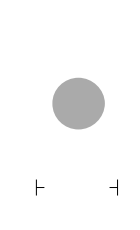

periodcentered 00B7

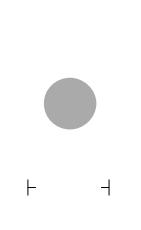

anoteleia 0387

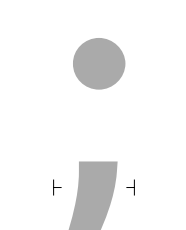

questiongreek 037E

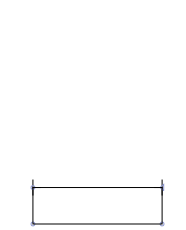

underscore 005F

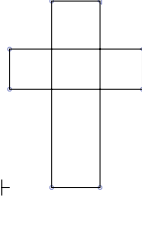

dagger 2020

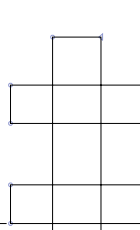

daggerdbl 2021

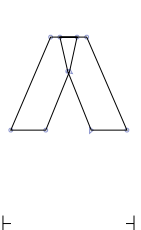

asciicircum 005E

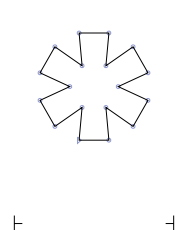

asterisk 002A



asterisk.case

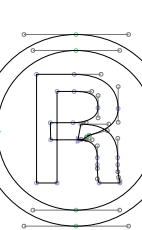

registered 00AE

trademark 2122

servicemark 2120

degree 00B0

ordfeminine 00AA

ordmasculine 00BA

i.numr

n.numr

paragraph 00B6

section 00A7

copyright 00A9

infinity 221E

partialdiff 2202

summation 2211

product 220F

integral 222B

radical 221A

emptyset 2205

lozenge 25CA

a.sups 1D43

b.sups 1D47

c.sups 1D9C

d.sups 1D48

e.sups 1D49

f.sups 1DA0

g.sups 1D4D

h.sups 02B0

i.sups 2071

j.sups 02B2

k.sups 1D4F

l.sups 02E1

m.sups 1D50

n.sups 207F

o.sups 1D52

p.sups 1D56

q.sups 146B

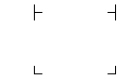
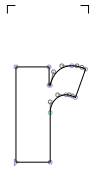

r.sups 02B3

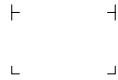
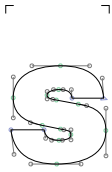

s.sups 02E2

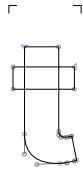

t.sups 1D57

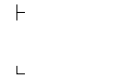
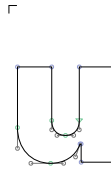

u.sups 1D58

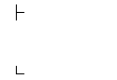
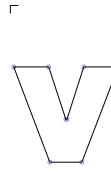

v.sups 1D58

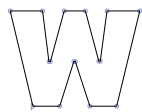

w.sups 02B7

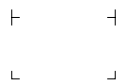
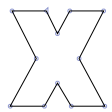

x.sups 02E3

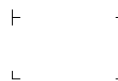

y.sups 02B8

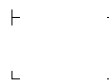
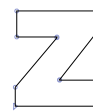

z.sups 1DBB

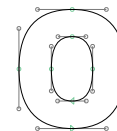

zero.sups 2070

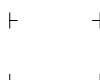
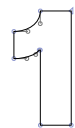

one.sups 00B9

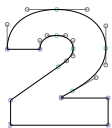

two.sups 00B2

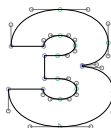

three.sups 00B3

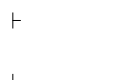
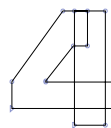

four.sups 2074

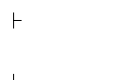
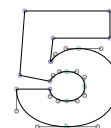

five.sups 2075

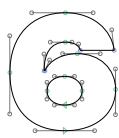

six.sups 2076

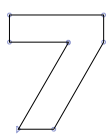

seven.sups 2077

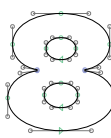

eight.sups 2078

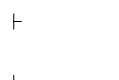
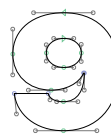

nine.sups 2079

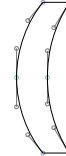

parenleft.sups 207D

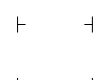

parenright.sups 207E



plus.sups 207A



minus.sups 207B



equal.sups 207C



a.subs 2090

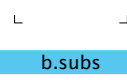
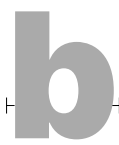

b.subs

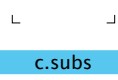

c.subs

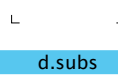

d.subs

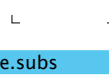

e.subs 2091



f.subs

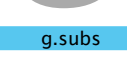

g.subs

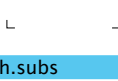

h.subs 2095

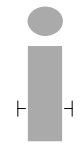

i.subs 1D62



j.subs 2C7C

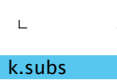

k.subs 2096



l

l.subs

2097

m

m.subs

2098

n

n.subs

2099

o

o.subs

2092

p

p.subs

209A

q

q.subs

r

r.subs

1D63

s

s.subs

209B

t

t.subs

209C

u

u.subs

1D64

v

v.subs

1D65

w

w.subs

x

x.subs

2093

y

y.subs

z

z.subs

0

zero.subs

2080

1

one.subs

2081

2

two.subs

2082

3

three.subs

2083

4

four.subs

2084

5

five.subs

2085

6

six.subs

2086

7

seven.subs

2087

8

eight.subs

2088

9

nine.subs

2089

(

parenleft.subs

208D

)

parenright.subs

208E

+

plus.subs

208A

-

minus.subs

208B

=

equal.subs

208C

0

zero.dnomf

1

one.dnomf

2

two.dnomf

3

three.dnomf

4

four.dnomf

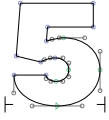

five.dnomf

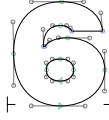

six.dnomf

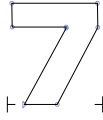

seven.dnomf

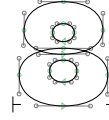

eight.dnomf



nine.dnomf

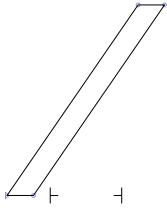

fraction 2044

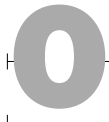

zero.dnom



one.dnom



two.dnom



three.dnom



four.dnom



five.dnom



six.dnom



seven.dnom

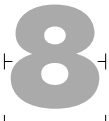

eight.dnom



nine.dnom



plus.dnom



minus.dnom



equal.dnom

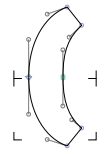

parenleft.dnom



zero.numr



one.numr



two.numr



three.numr

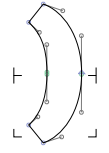

parenright.dnom



four.numr



five.numr



six.numr



seven.numr



eight.numr



nine.numr

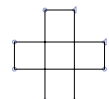

plus.numr

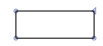

minus.numr

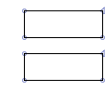

equal.numr

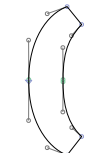

parenleft.numr

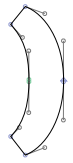

parenright.numr

0

zero.frac

1

one.frac

2

two.frac

3

three.frac

4

four.frac

5

five.frac

6

six.frac

7

seven.frac

8

eight.frac

9

nine.frac

1/2

onehalf

00BD

1/4

onequarter

00BC

3/4

threequarters

00BE

5/6

fivesixths

215A

1/8

onefraction

215F

7/8

seveneighths

215E

1/8

oneeighth

215B

5/8

fiveeighths

215D

3/8

threeeighths

215C

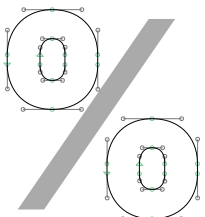

percent

0025

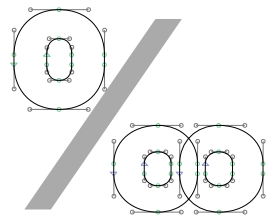

perthousand

2030

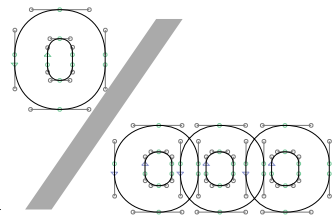

pertenthousand

2031

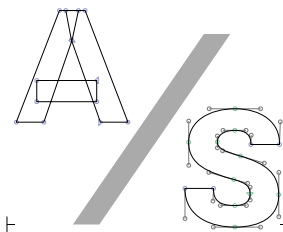

uni214D

214D

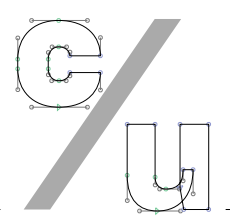

cadauna

2106

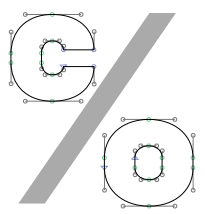

careof

2105

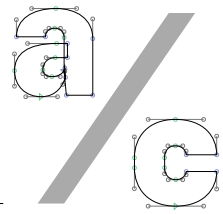

accountof

2100

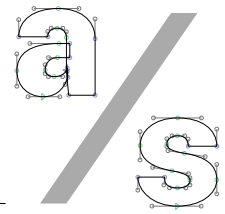

addresssubject

2101

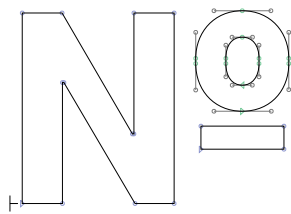

numero

2116

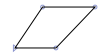

acute

0084

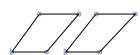

hungarumlaut

02DD



grave

0060



tonos

0384



dieresis









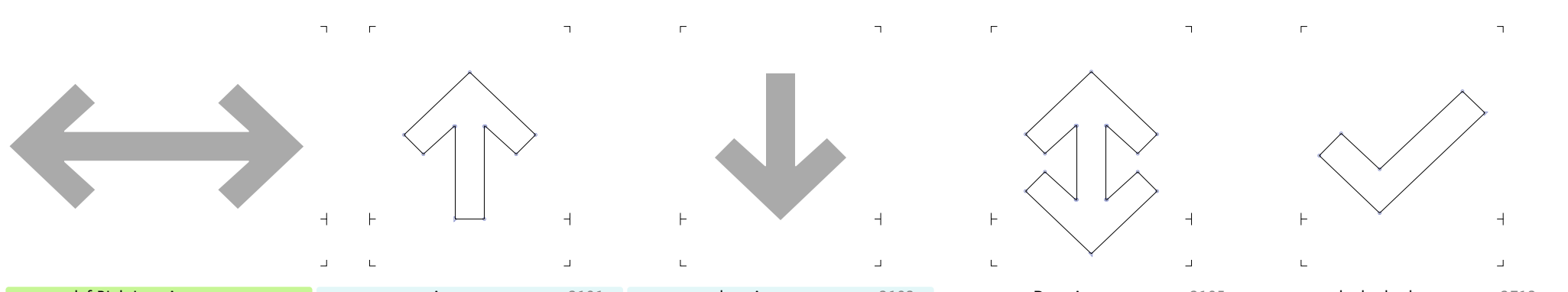
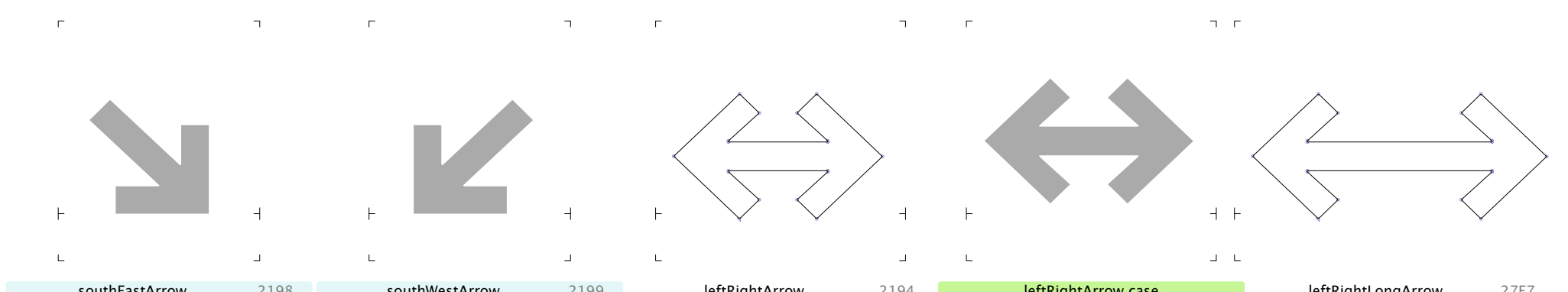
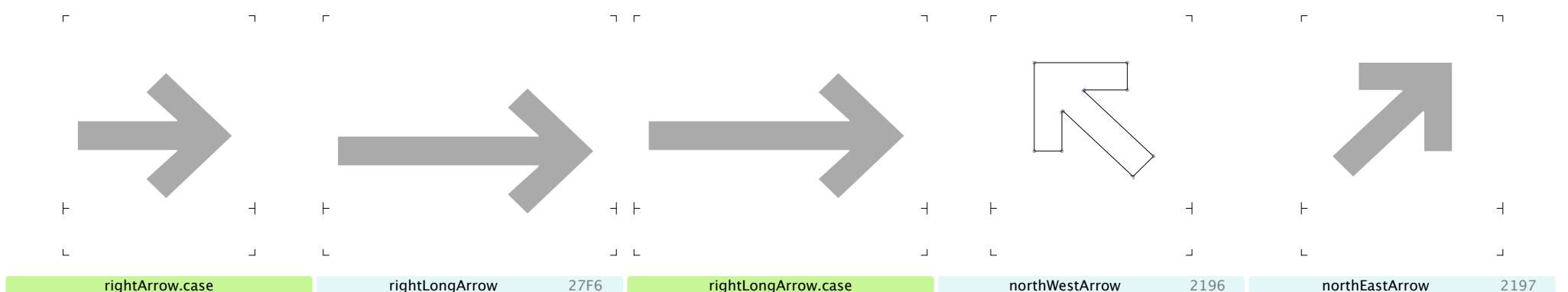
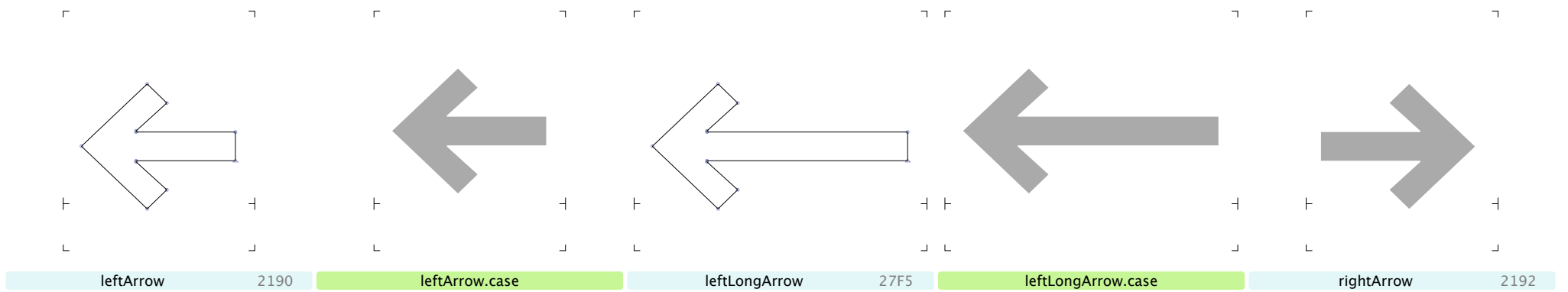
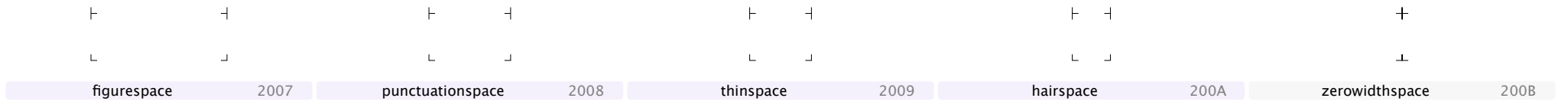
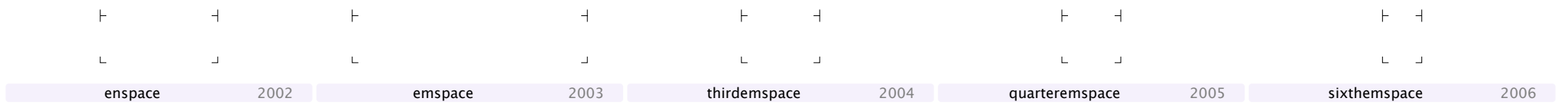
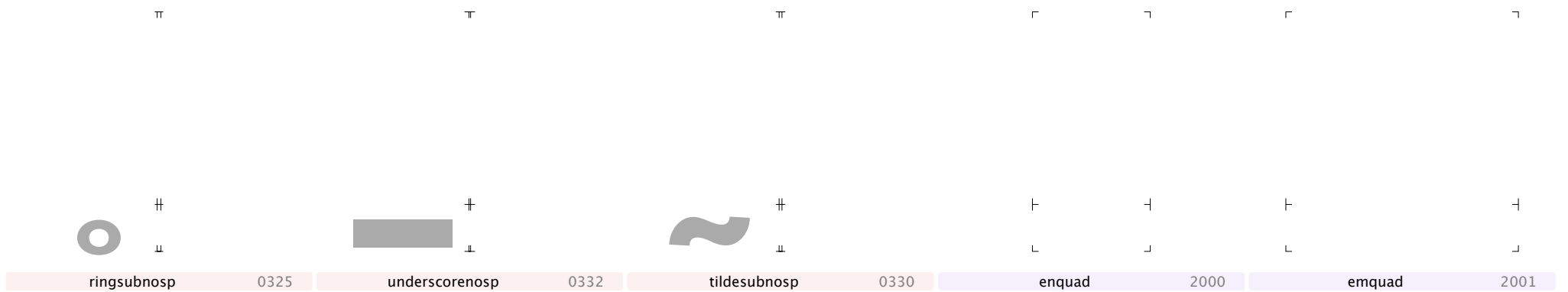

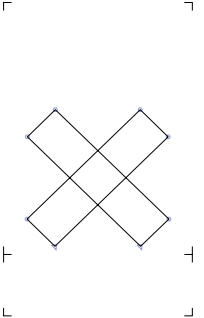

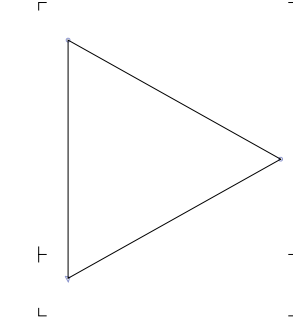

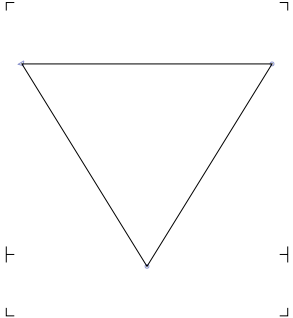

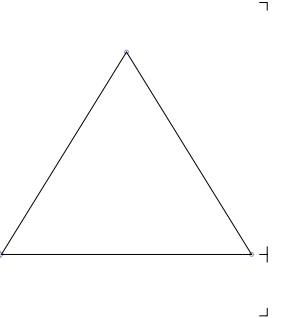

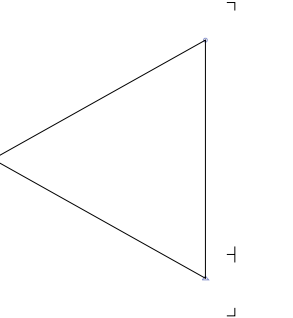

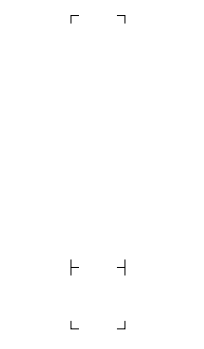

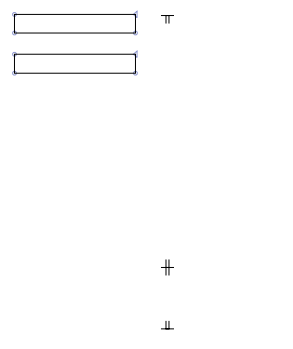

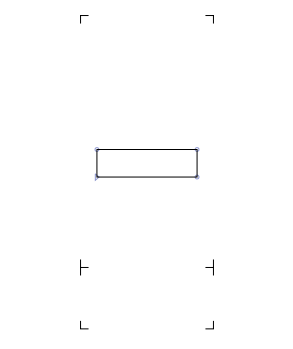
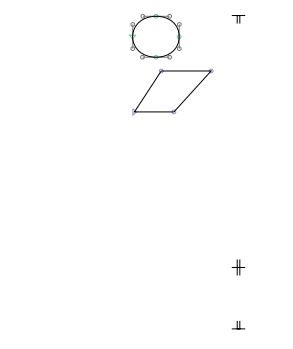

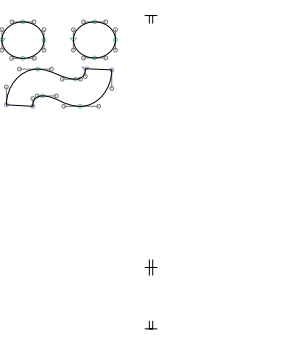

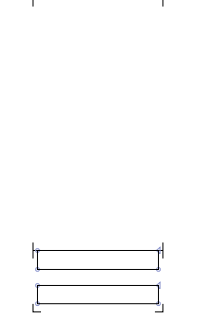

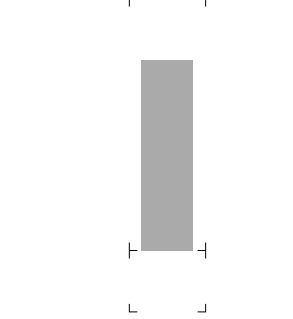

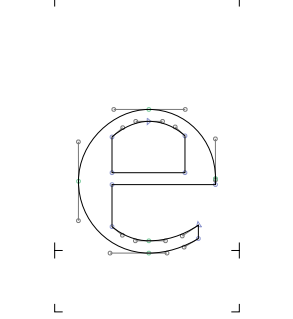
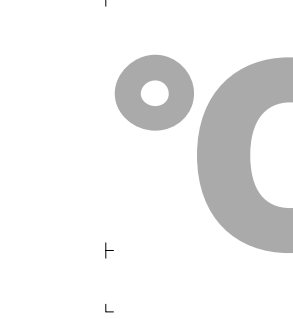

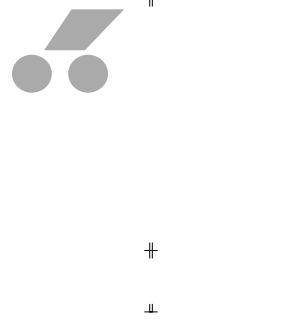

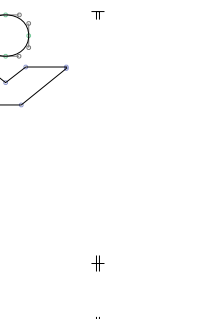

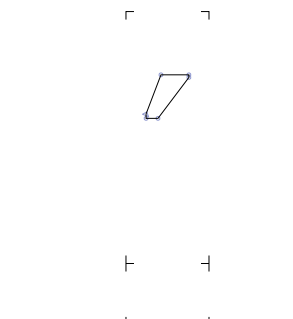

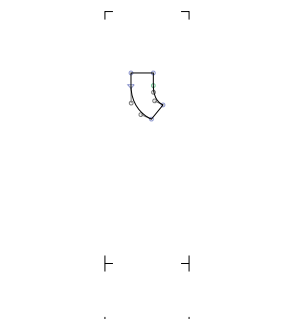
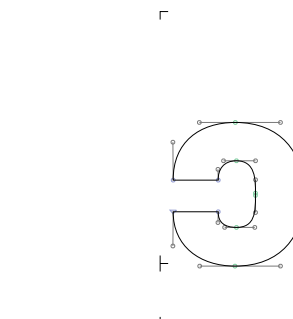

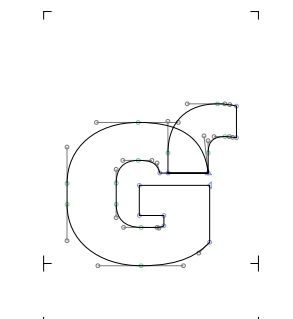

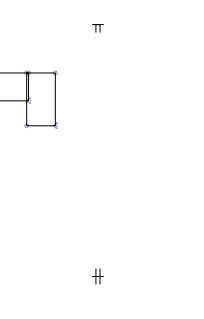

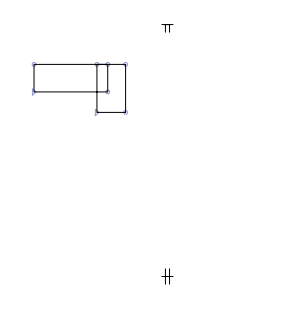

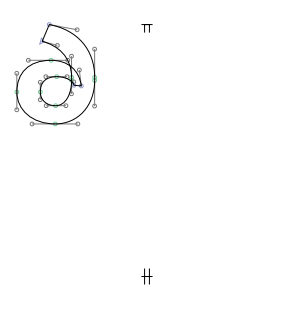
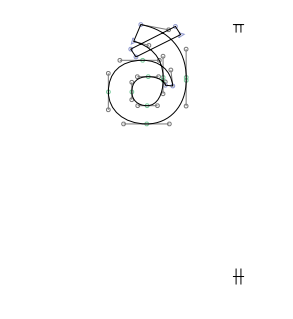

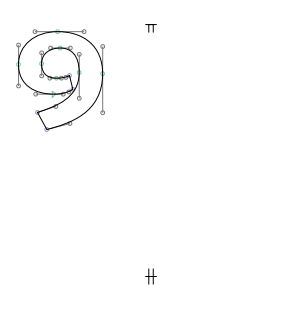

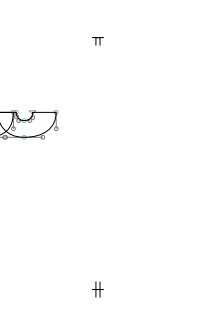

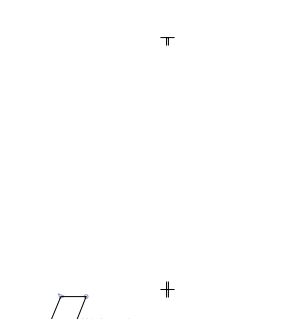

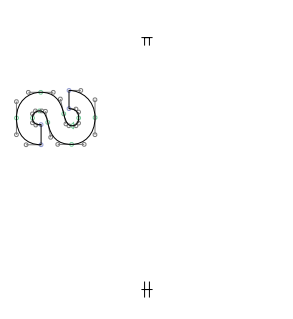
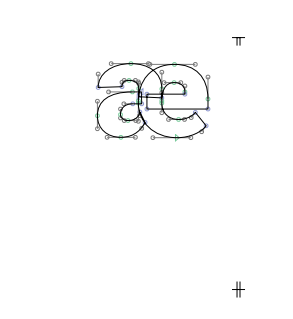

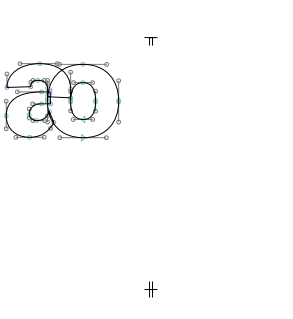
00A8

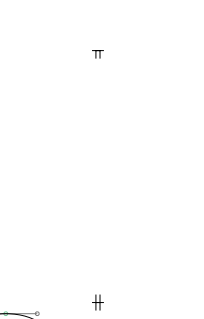

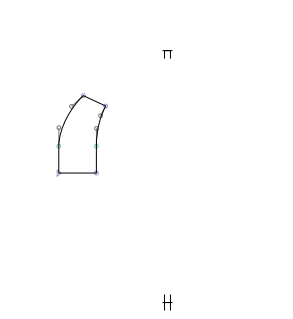
casedieresis.cn

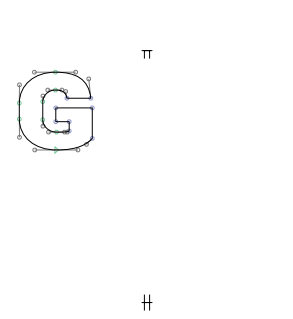
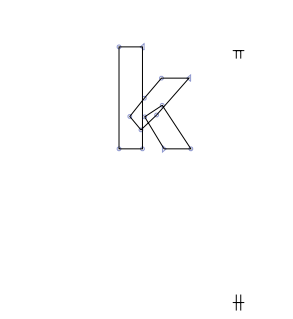
circumflex 02C6	tilde 02DC	casetilde.cn	macron 00AF	breve 02D8
cyrillicbreve	dotaccent 02D9	ring 02DA	caron 02C7	dieresis 0385
cedilla 00B8	ogonek 02DB	commaaccent F6C3	acutecomb 0301	acutedblnosp 030B
gravecomb 0300	dblgravecmb 030F	macroncomb 0304	dieresisnosp 0308	brevensp 0306
breveinvnosp 0311	hook 0309	circumflexnosp 0302	caroncmb 030C	tildecomb 0303
dotnosp 0307	ringnosp 030A	hornnosp 031B	ogoneknosp 0328	cedillanosp 0327
circumflexsubnosp 032D	brevesubnosp 032E	dotbelow 0323	commabelowcmb 0326	dotdblsubnosp 0324

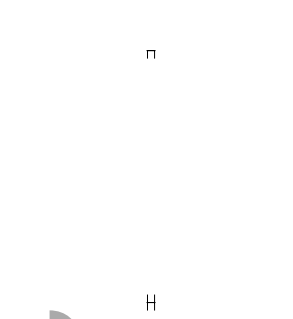

uni1DDF 1DDF	uni1DDD 1DDD	uni1DDE 1DDE	romanten 2169	degreefarenheit 2109
degreekelvin 212A	uni02AB 02AB	uni02AC 02AC	uni1FCD 1FCD	kappa1 03F0
uni214F 214F	OESmallcap 0276	tackupsubnosp 031D	uni2DFF 2DFF	glottalstopbarinv 01BE
seagullsubnosp 033C	uni02EC 02EC	afi300 200F	caronsubnosp	romanfour 2163
uni03F5 03F5	uni03F6 03F6	longs 017F	trianglebullet 2023	Ysmallcap 028F
uni03FB 03FB	uni03FD 03FD	uni03FE 03FE	uni03FF 03FF	uni0373 0373
uni0372 0372	uni0371 0371	uni0370 0370	uni0377 0377	gravesubnosp 0316

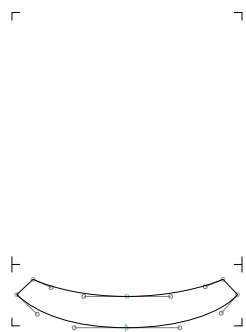

undertie 203F



barmidshortnosp 0335

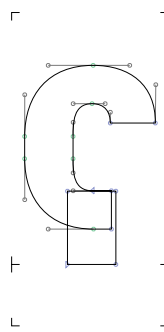

glottalstoprevinv 0295

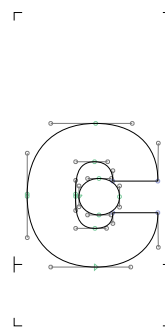

uni037C 037C

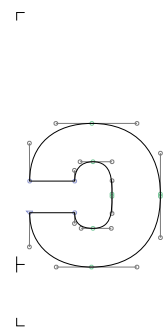

uni037B 037B

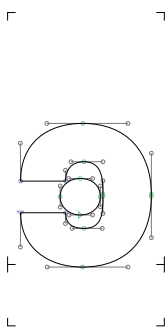

uni037D 037D

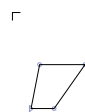

primemod 02B9

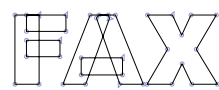

uni213B 213B

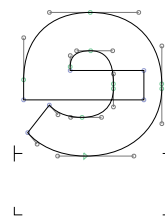

erev 0258

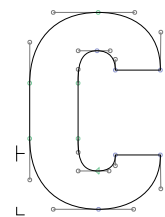

cstretch 0297



Btopbar 0182

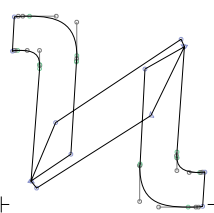

Koppa 03DE



commaturnedmod 02BB



commareversedmod 02BD



ringhalfleft 02BF

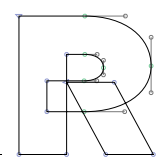

Rsmallcap 0280

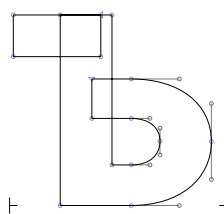

Tonesix 0184

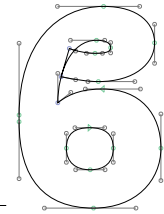

beta1 03D0



uni204F 204F



uni204E 204E

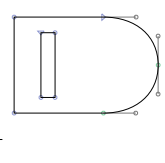

uni204D 204D

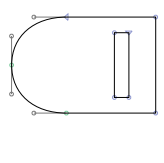

uni204C 204C

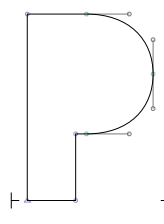

uni204B 204B

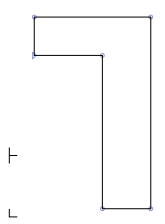

uni204A 204A

CR

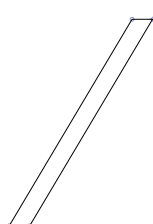

slashlongnosp 0338



exclam1 01C3

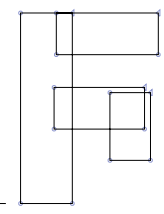

Digamma 03DC

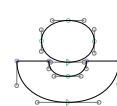

candrabinunosp 0310

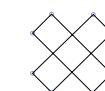

qofdagesh 02DF

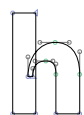

uni036A 036A

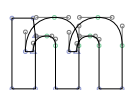

uni036B 036B



uni036C 036C

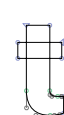

uni036D 036D



uni036E 036E



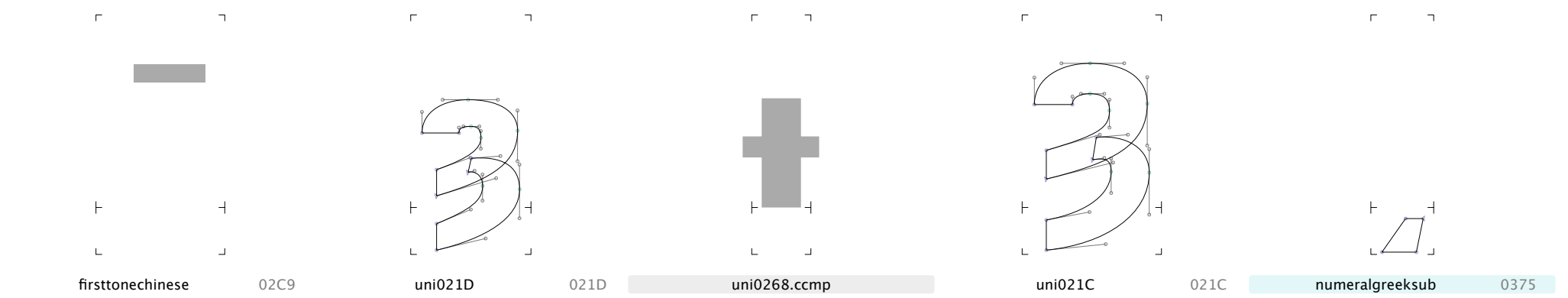
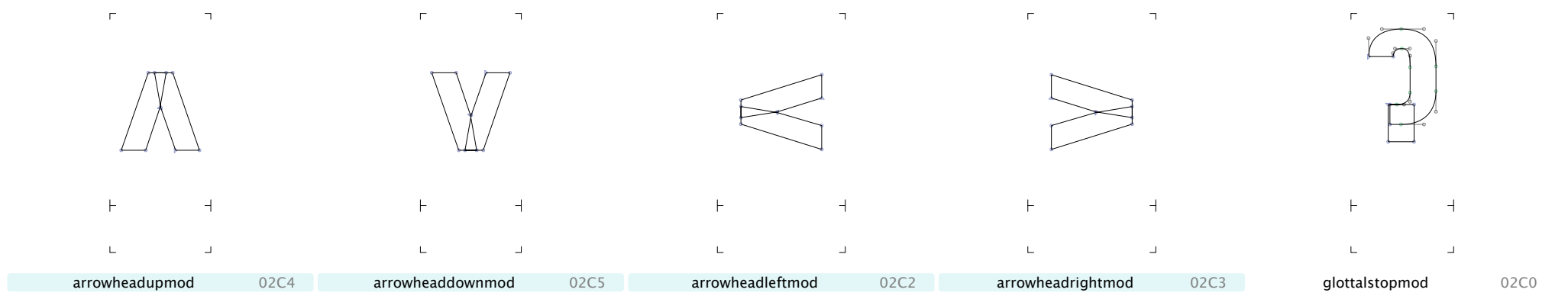
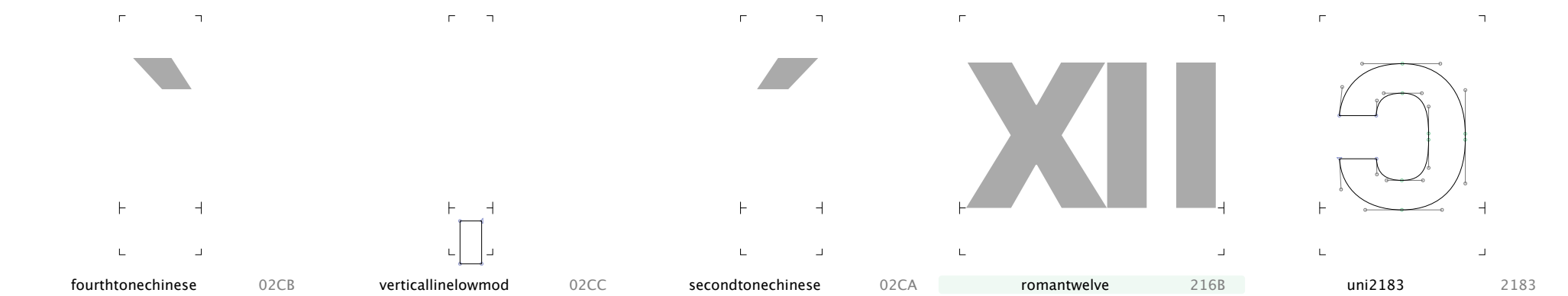
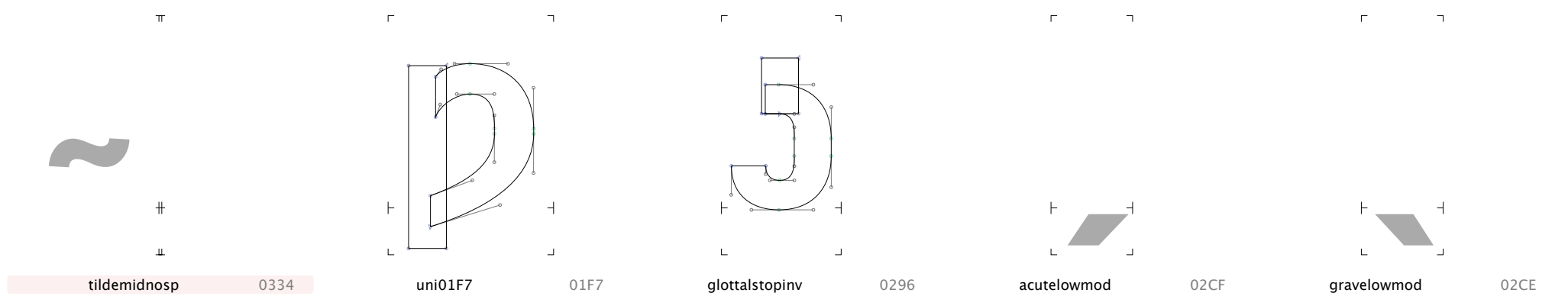
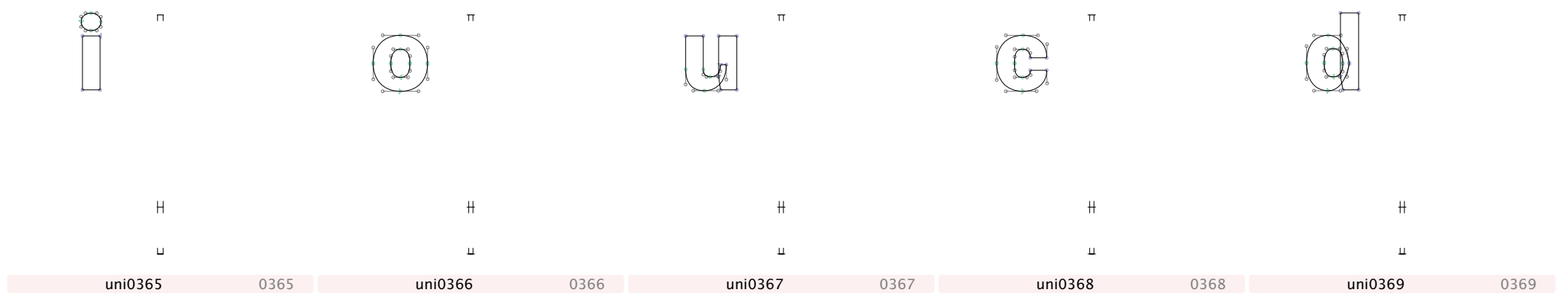
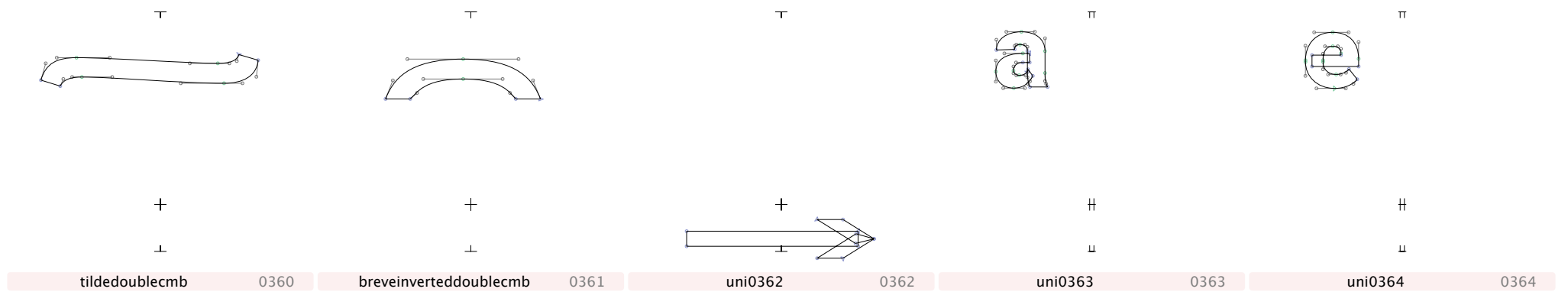
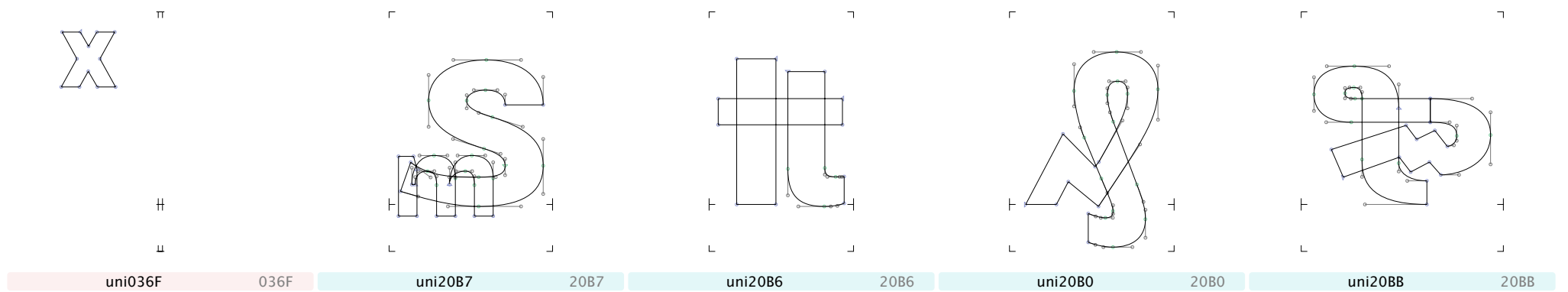

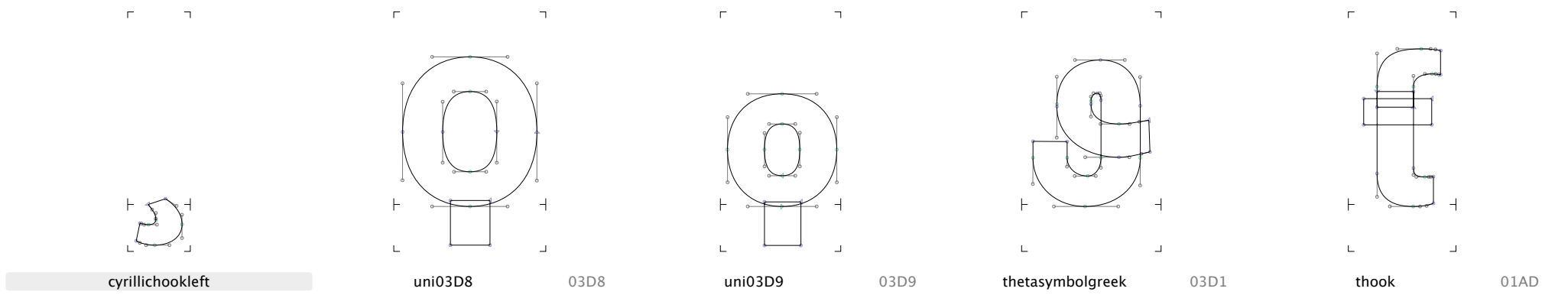
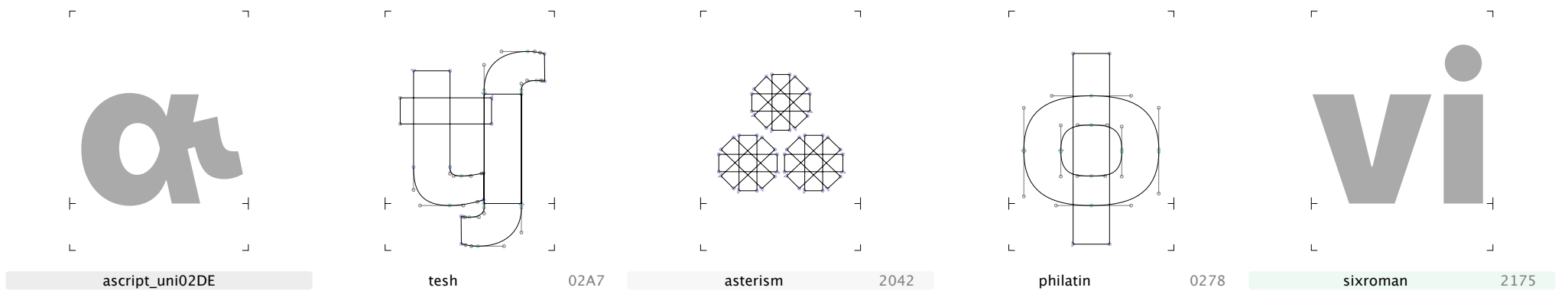
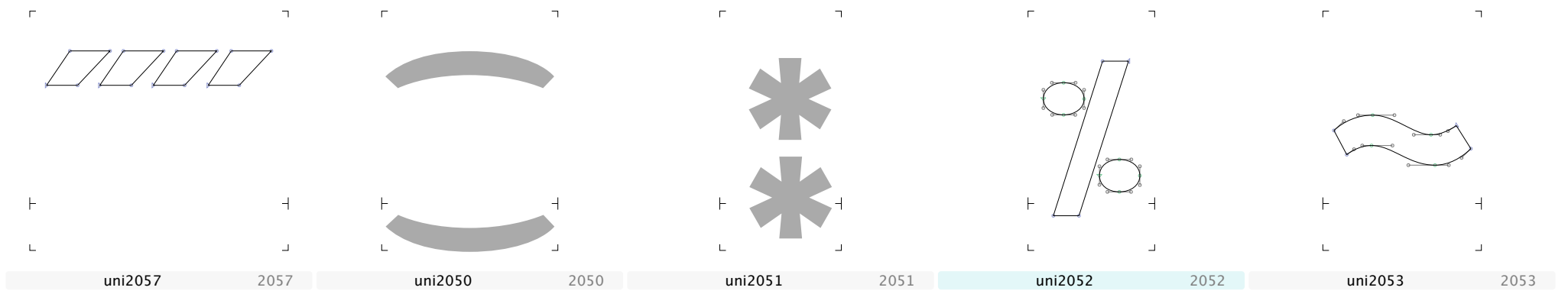
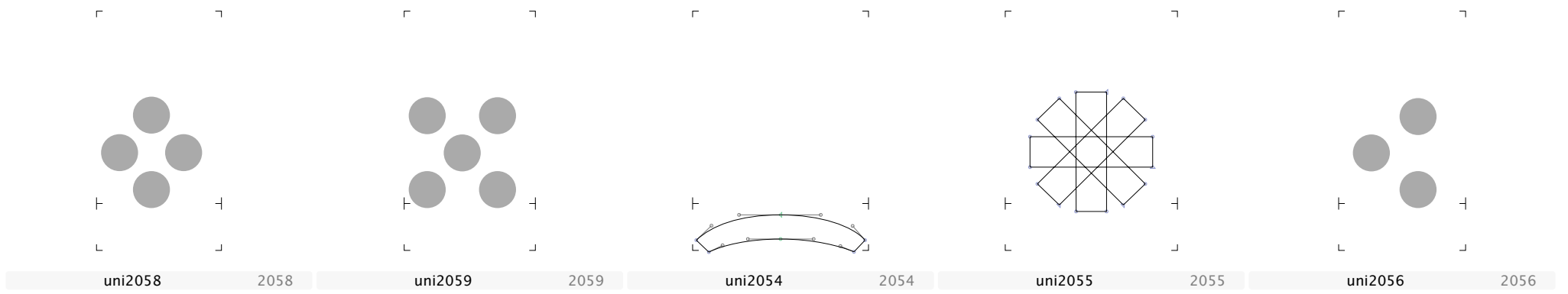
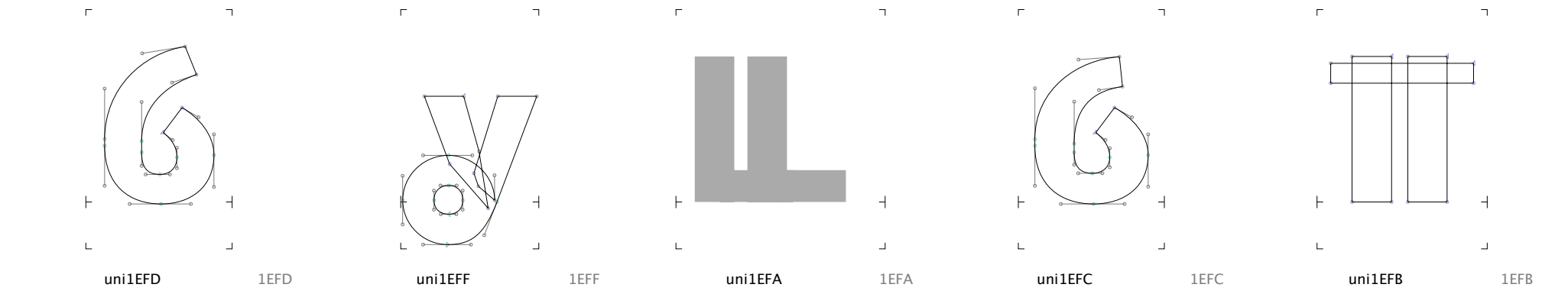
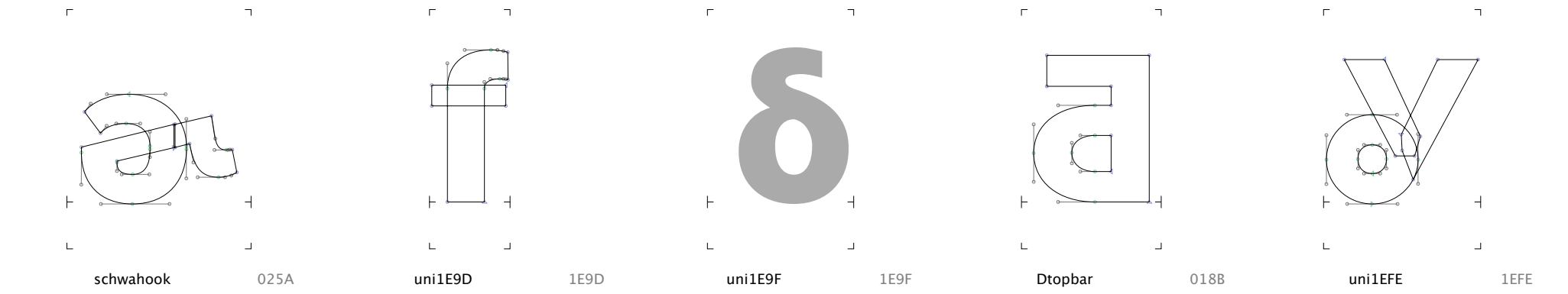
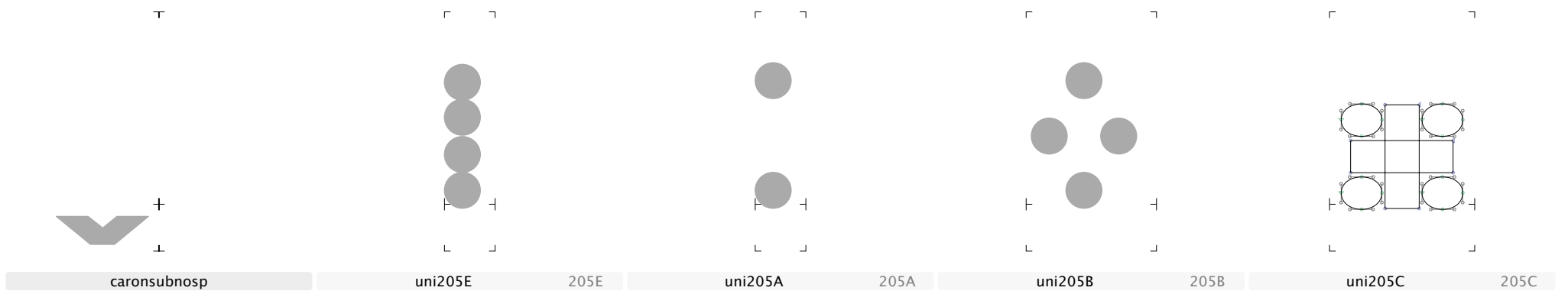

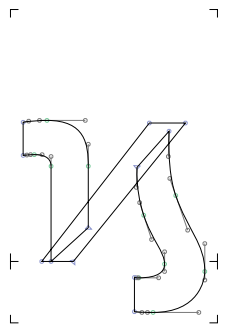

uni03D7

03D7

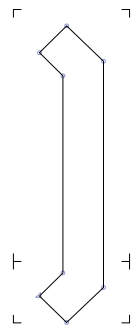

uni27EF

27EF

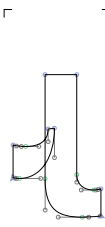

finaltsadi

02B5

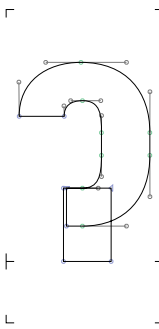

glottalstop

0294



uni0359

0359



uni0358

0358



uni0355

0355



uni0354

0354



uni0357

0357



uni0356

0356



uni0351

0351



uni0350

0350



uni0353

0353

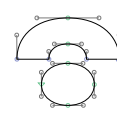

uni0352

0352

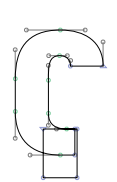

glottalstopreversedmod

02C1

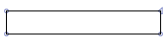

uni035E

035E

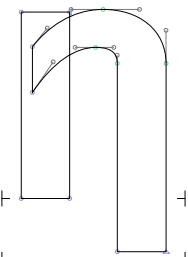

uni0220

0220

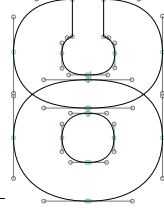

uni0223

0223

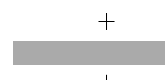

uni035F

035F

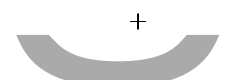

uni035C

035C



uni035B

035B

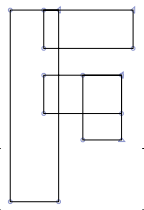

digamma

03DD

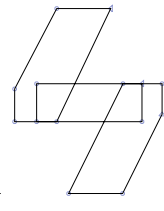

koppa

03DF



ringhalfrightcentered

02D2



colontriangularhalfmod

02D1



colontriangularmod

02D0



minusmod

02D7

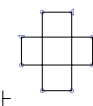

plusmod

02D6

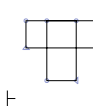

downtackmod

02D5



linevertnosp

030D

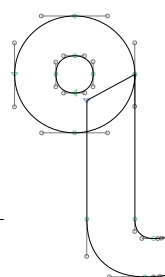

eshlooprev

01AA



verticalbardbl

2016



romaneleven

216A

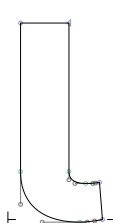

lota1

0196

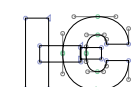

uniA69F

A69F

lsquare 2113	rhotichookmod 02DE	uni1DD6 1DD6	uni1DD7 1DD7	linevertsubnosp 0329
mcapturen 019C	uni205D 205D	spaceopenbox 2423	uni034B 034B	uni034C 034C
uni034A 034A	uni034F 034F	uni034D 034D	uni034E 034E	uni0348 0348
uni0349 0349	reverseddblprime 2036	perispomenigreekcmb 0342	koroniscmb 0343	uni0347 0347
uni0238 0238	uni0239 0239	tackdownsubnosp 031E	uni02EA 02EA	uni02EB 02EB
uni2071.ccmp	uni02ED 02ED	uni02EF 02EF	glottalstopreversed.numr 02E4	afii61664 200C
uni1DC6 1DC6	uni1DC4 1DC4	babygamma 0264	Vcursive 01B2	wynn 01BF

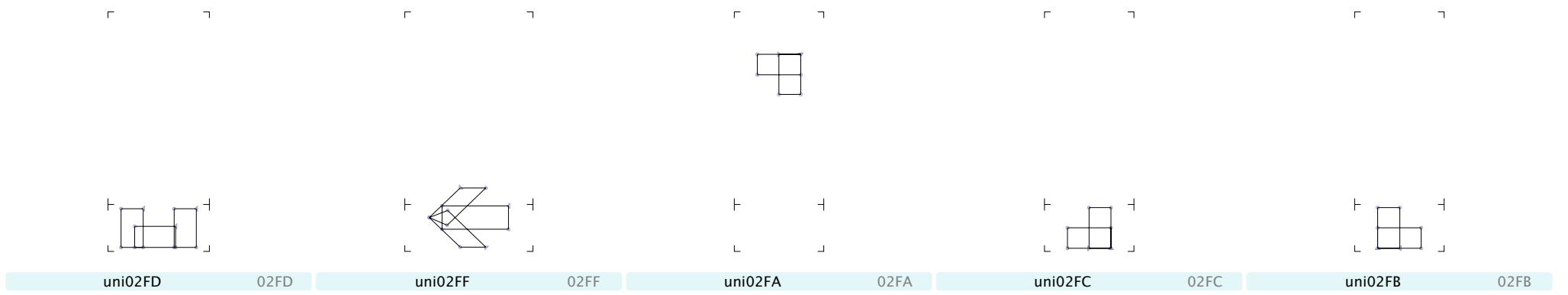
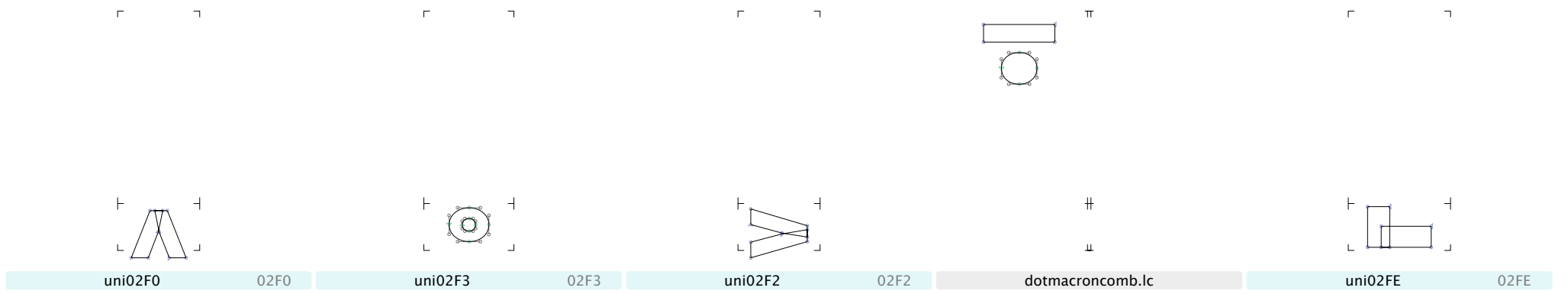
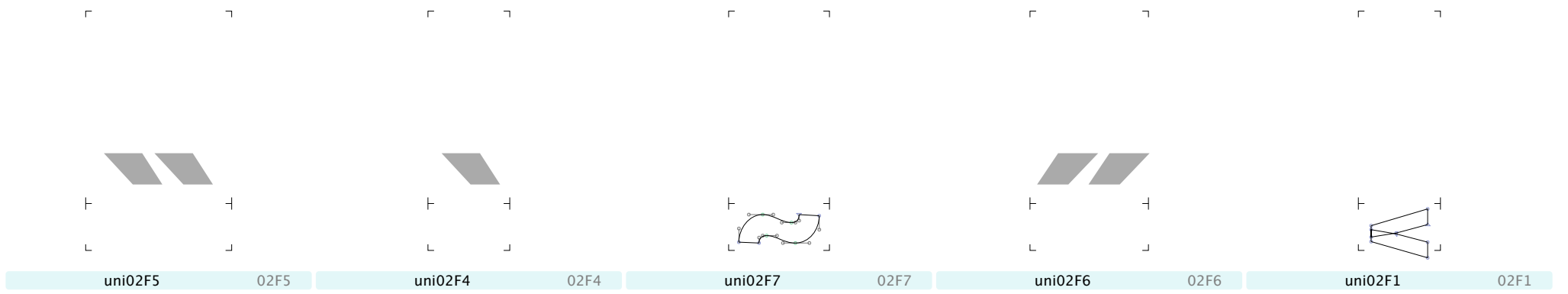
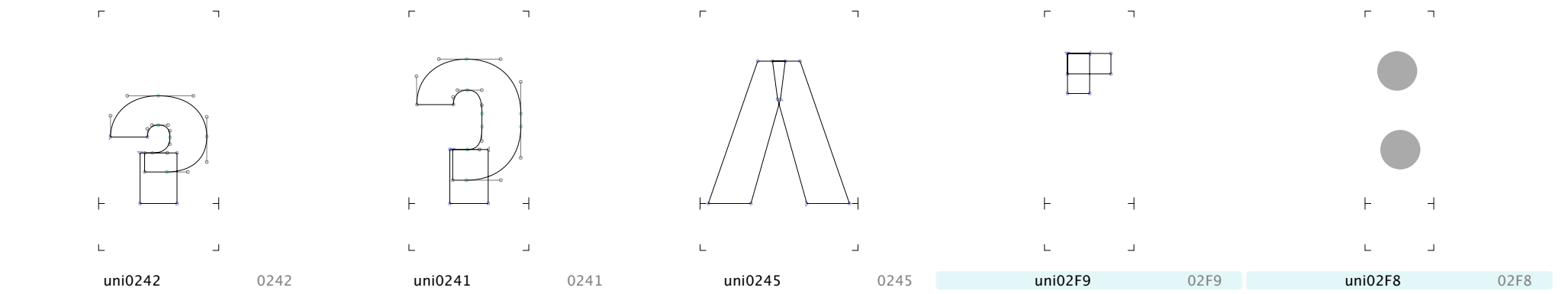
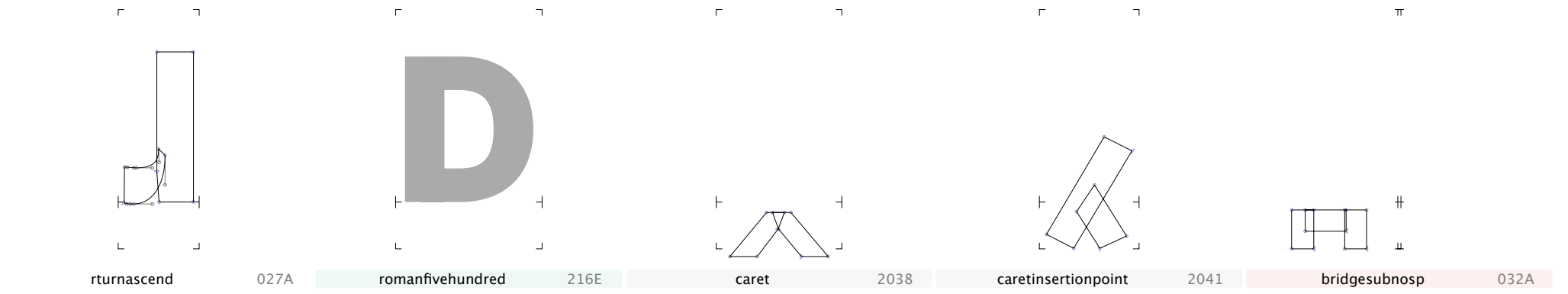
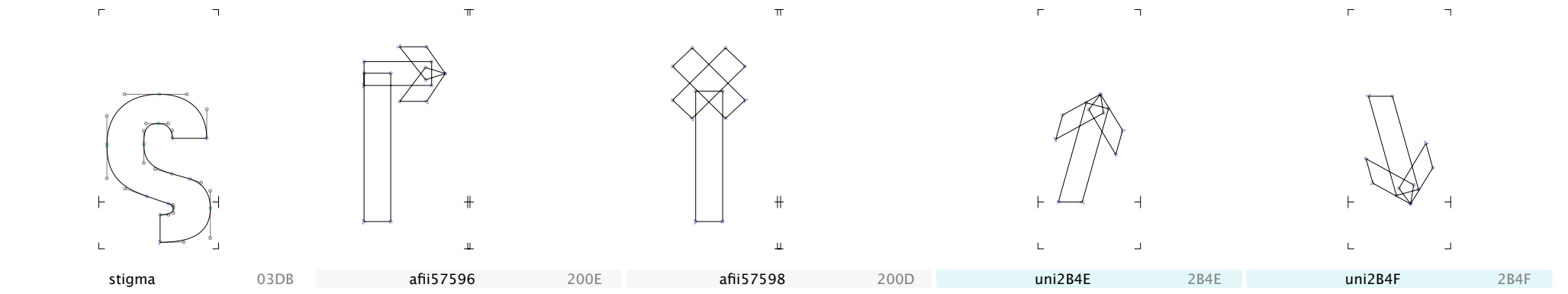
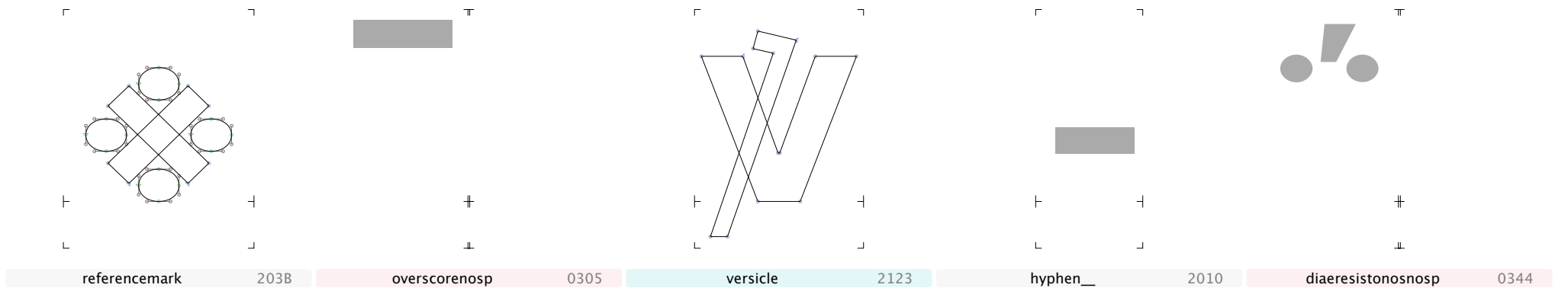

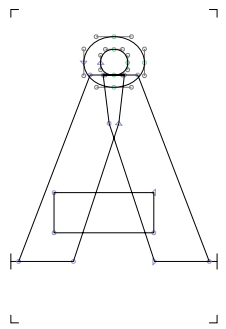

angstrom

212B

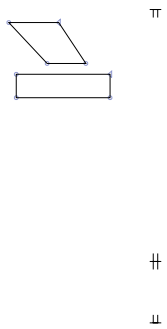

macrongravecomb.ic



macronsubnosp

0331



ringlefthalfsubnosp

031C

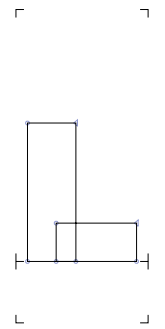

Lsmallcap

029F



squaresubnosp

033B

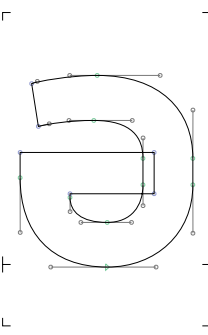

Schwa

018F

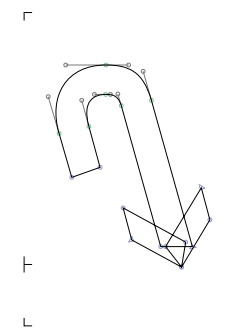

uni2B5B

2B5B

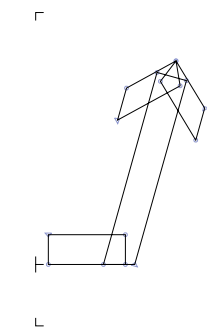

uni2B5C

2B5C

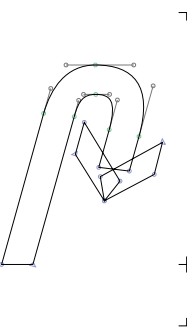

uni2B5A

2B5A

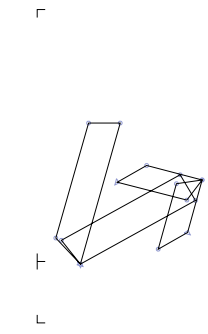

uni2B5F

2B5F

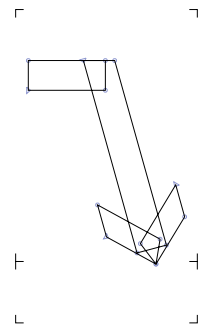

uni2B5D

2B5D

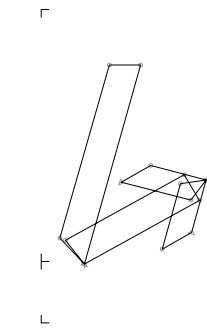

uni2B5E

2B5E

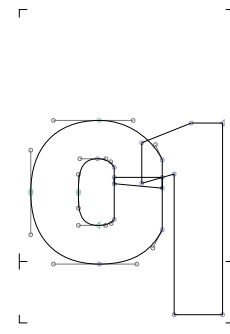

oi

01A3

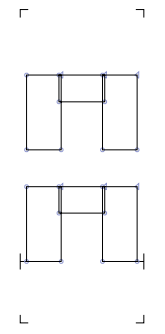

finalmem

02AD

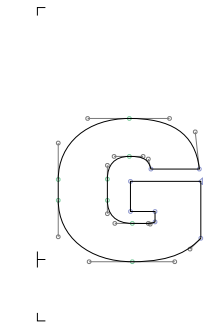

Gsmallcap

0262

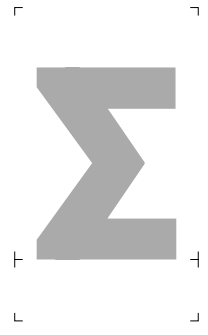

Esh

01A9



dieresismacroncomb.ic

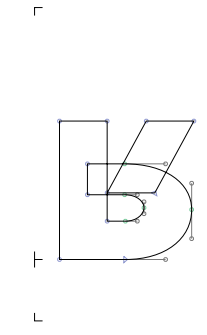

Rsmallcapinv

0281



zerowidthjoiner

FEFF

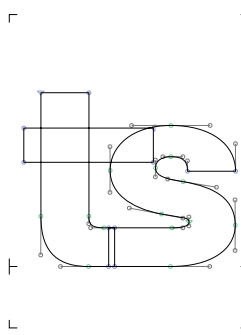

ts

02A6

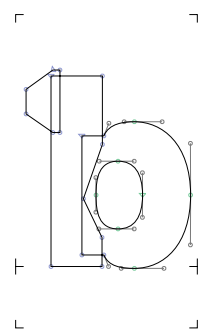

tonesix

0185

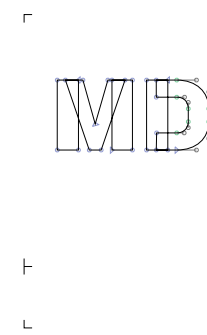

uni1F16B

1F16B

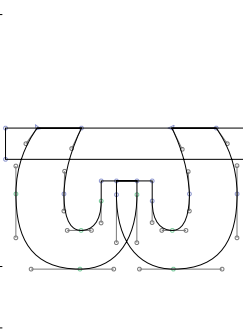

pisymbolgreek

03D6



uni1F16A

1F16A

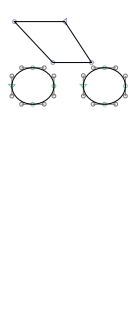

dieresisgravecomb.ic

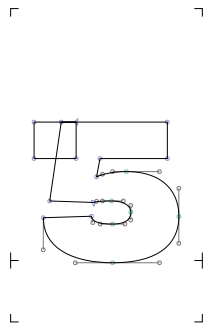

tonefive

018D

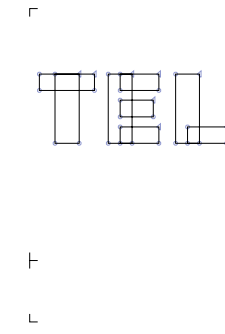

tel

2121



commasuprevnosp

0314



hyphennobreak

2011



archdblsubnosp

032B

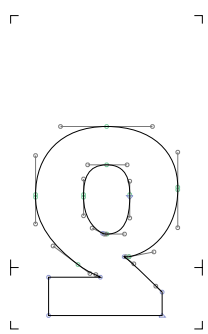

deltaturn

018D

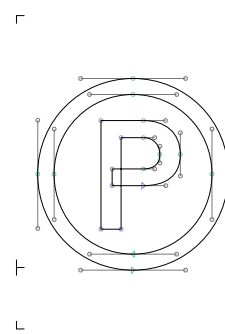

published

2117



macronacutecomb.ic

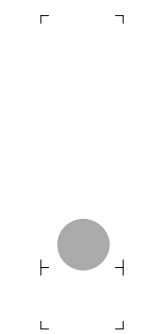

onedotleader

2024

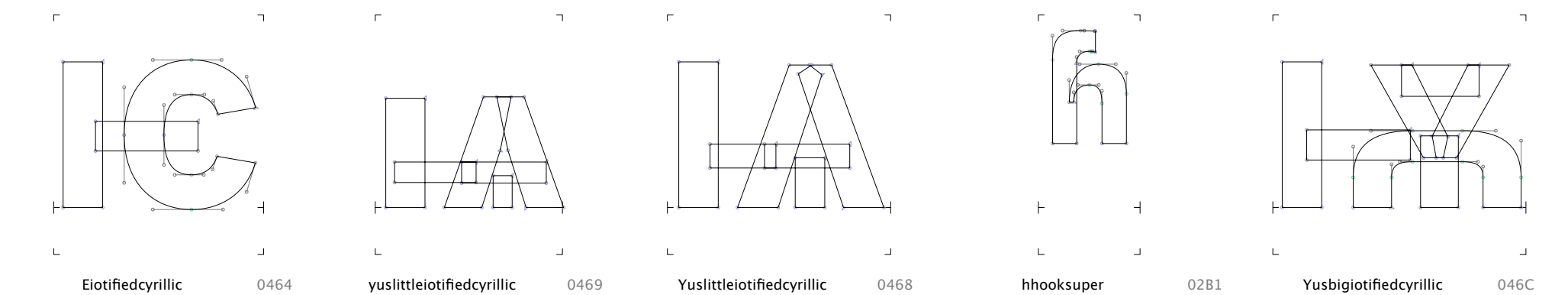
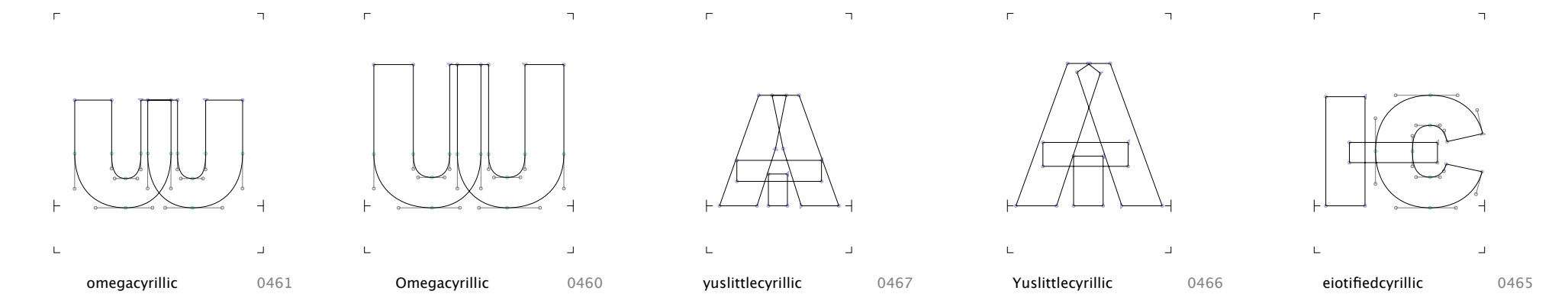
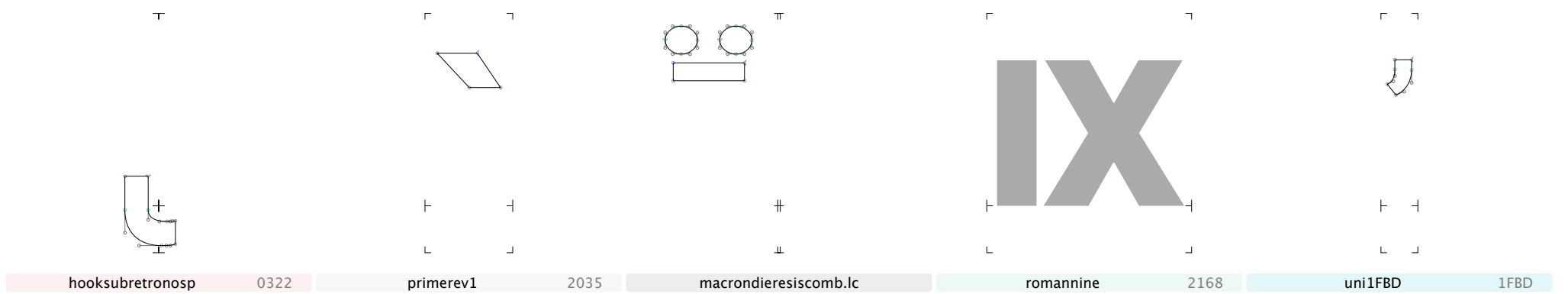
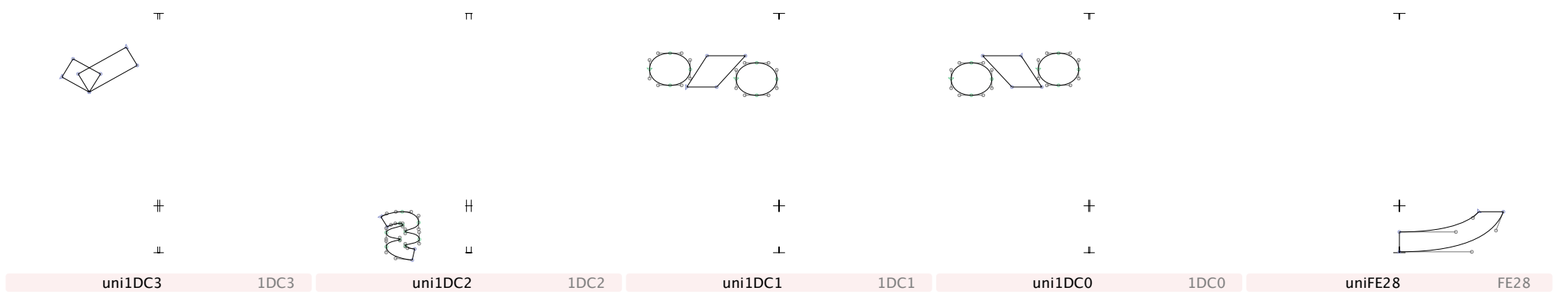
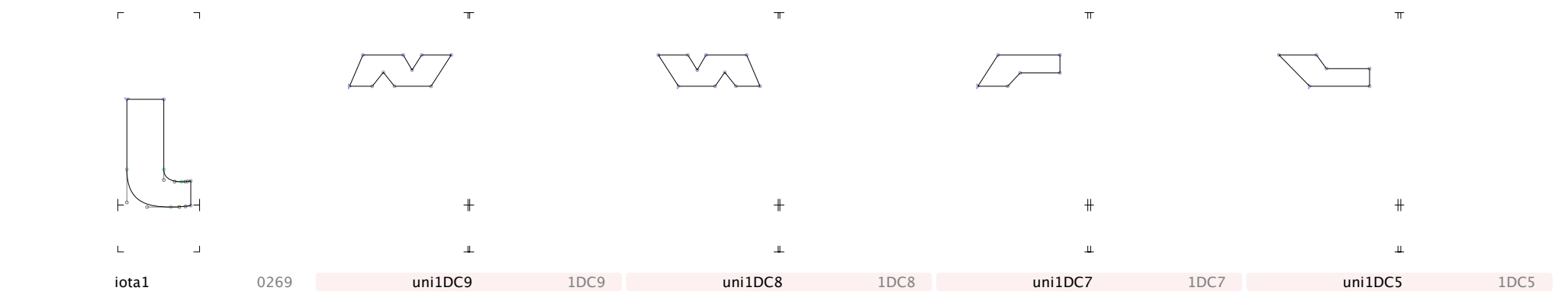
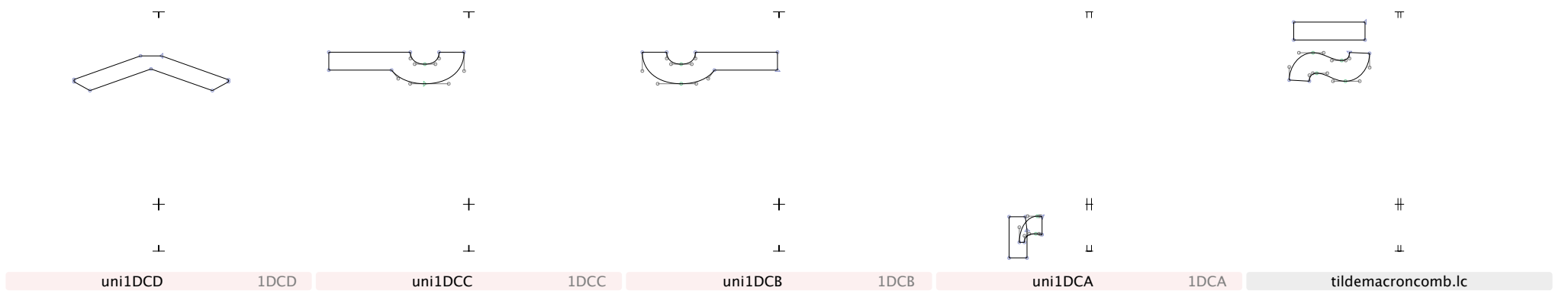
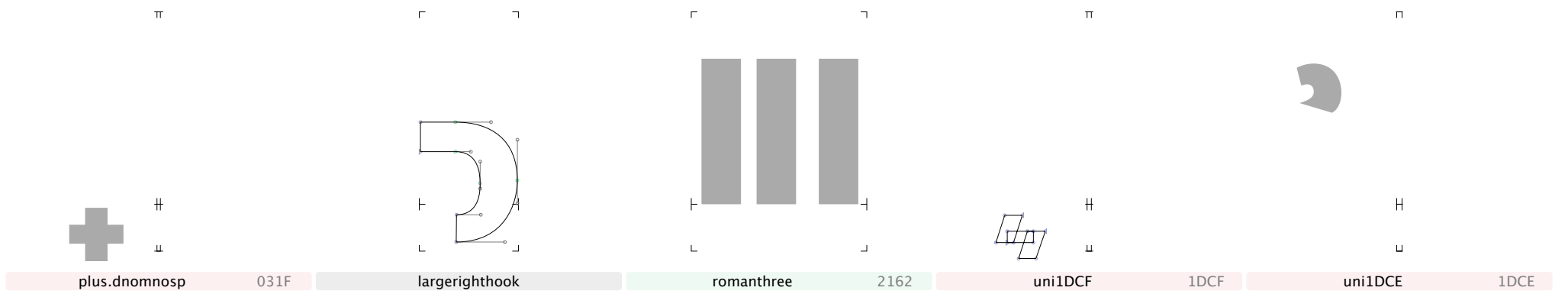

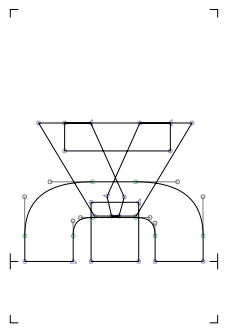

yusbigcyrillic 046B

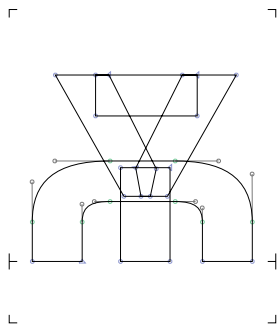

Yusbigcyrillic 046A

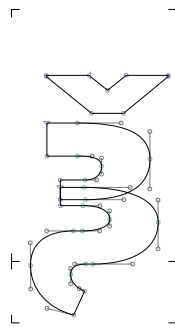

ksicyrillic 046F

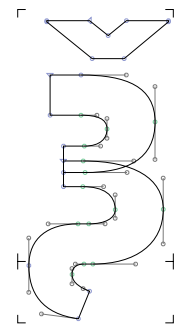

Ksicyrillic 046E

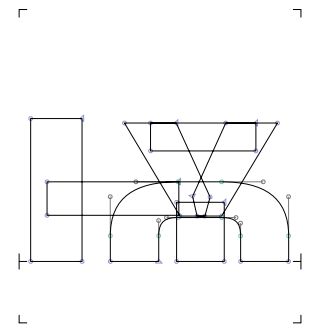

yusbigiotifiedcyrillic 046D



tildeacutecomb.lc



romanthousand 216F



macronsub 02CD

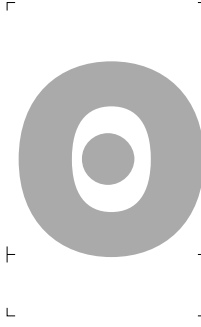

bullseye 0298

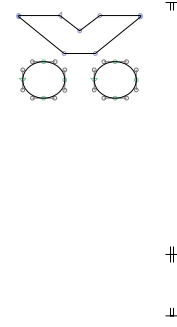

dieresiscaroncomb.lc

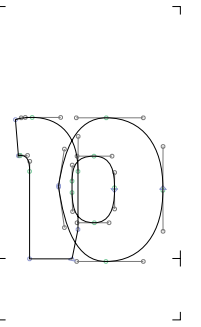

ascriptturn 0252

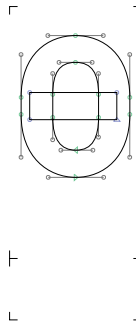

uni1DBF 1DBF



glottalstopbarrev 02A2



cyrillichook

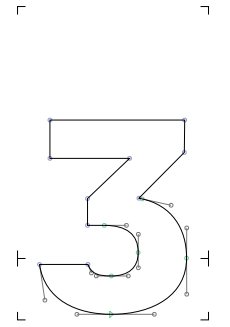

ezh 0292

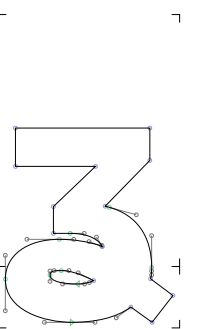

ezhcurl 0293

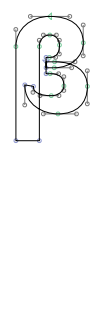

uni1DE9 1DE9



numeralgreek 0374

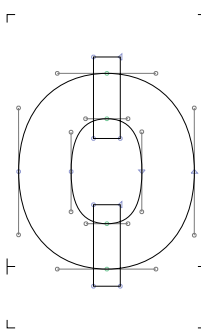

Omeгарoundcyrillic 047A

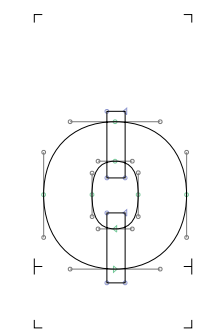

omegaroundcyrillic 047B

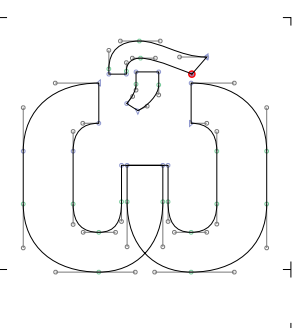

Omeɡatitlocyrillic 047C

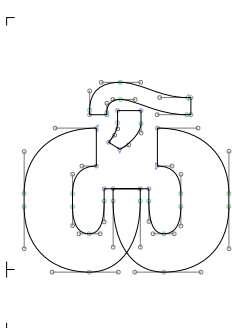

omeɡatitlocyrillic 047D

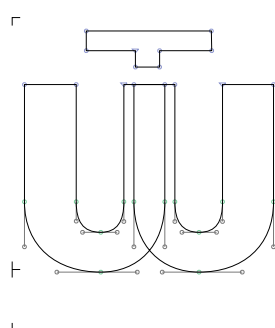

Otcyrillic 047E

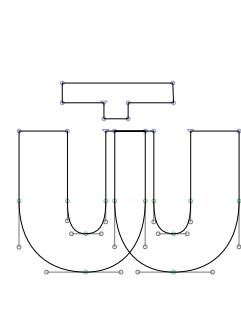

otcyrillic 047F



gcursive 0261

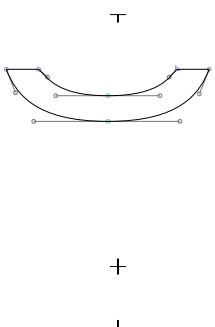

uni035D 035D



uni035A 035A



quotedblreversed 201F

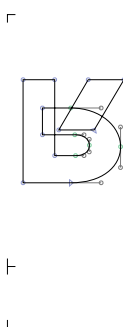

Rturnsuper 02B6

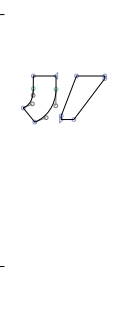

uni1FCE 1FCE

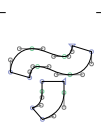

uni1FCF 1FCF

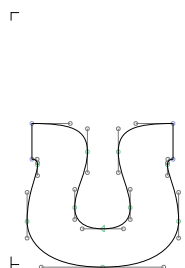

upsilonlatin 028A

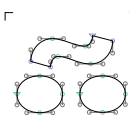

uni1FC1 1FC1



uni1FC0 1FC0



ringhalfleftcentered 02D3



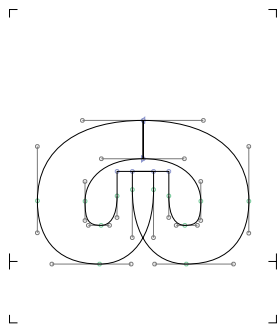

omegaclosed 0277



uni1DE2 1DE2

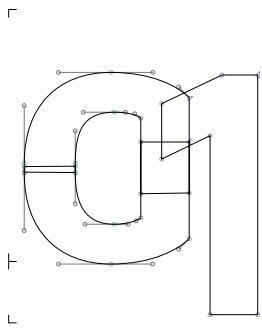

OI 01A2



xsupnosp 033D

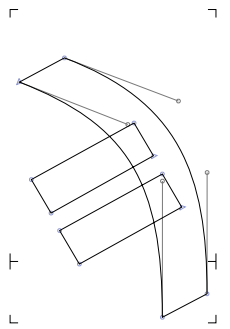

sampi 03E1

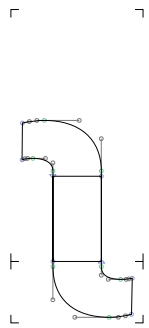

eshshortrev 0285

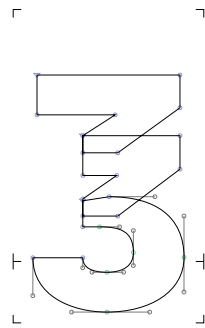

ounce 2125

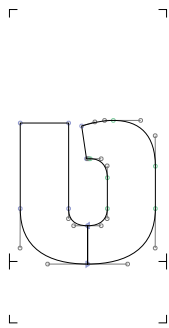

vsript 028B

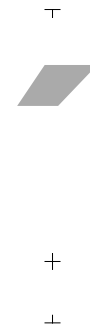

acuterightnosp 0341

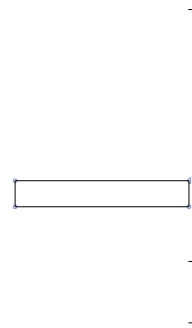

barmidlongnosp 0336



tildevertsupnosp 033E



linevertdblasp 030E



jhookdblbar 0284



overline 203E



ascrypt 0251

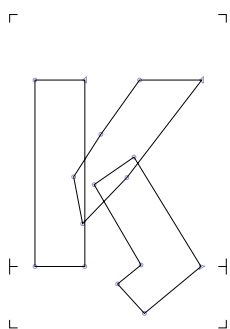

uni03CF 03CF

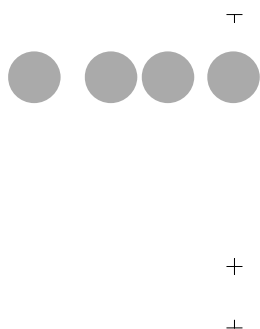

uni20DC 20DC



uni20DB 20DB



romansix 2165



uni1FBF 1FBF

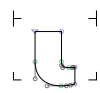

uni1FBE 1FBE



ypogegrammeni 037A



romaneight 2167

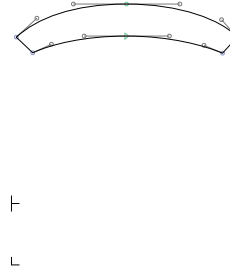

characterie 2040

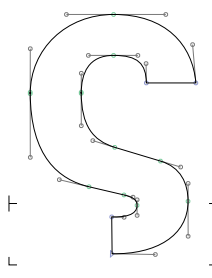

Stigma 03DA

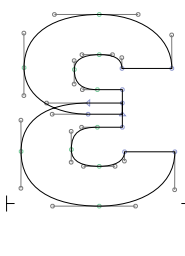

Epsilon1 0190



iotasubnosp 0345



pipedblbar 01C2

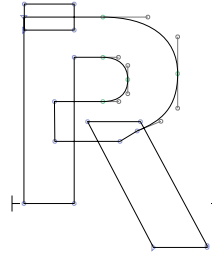

YR 01A6

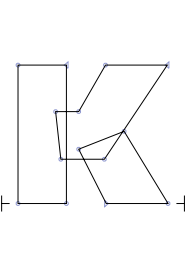

kgreenlandic 0138

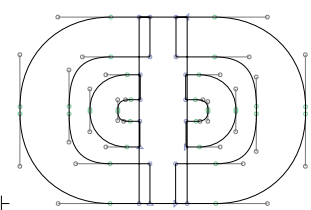

uni2182 2182

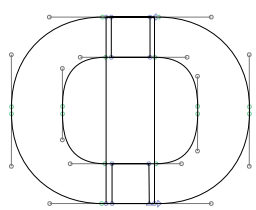

uni2180 2180

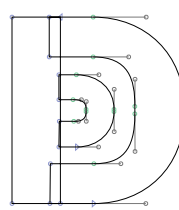

uni2181 2181

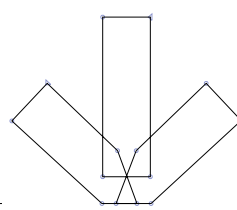

uni2186 2186

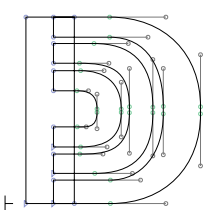

uni2187 2187

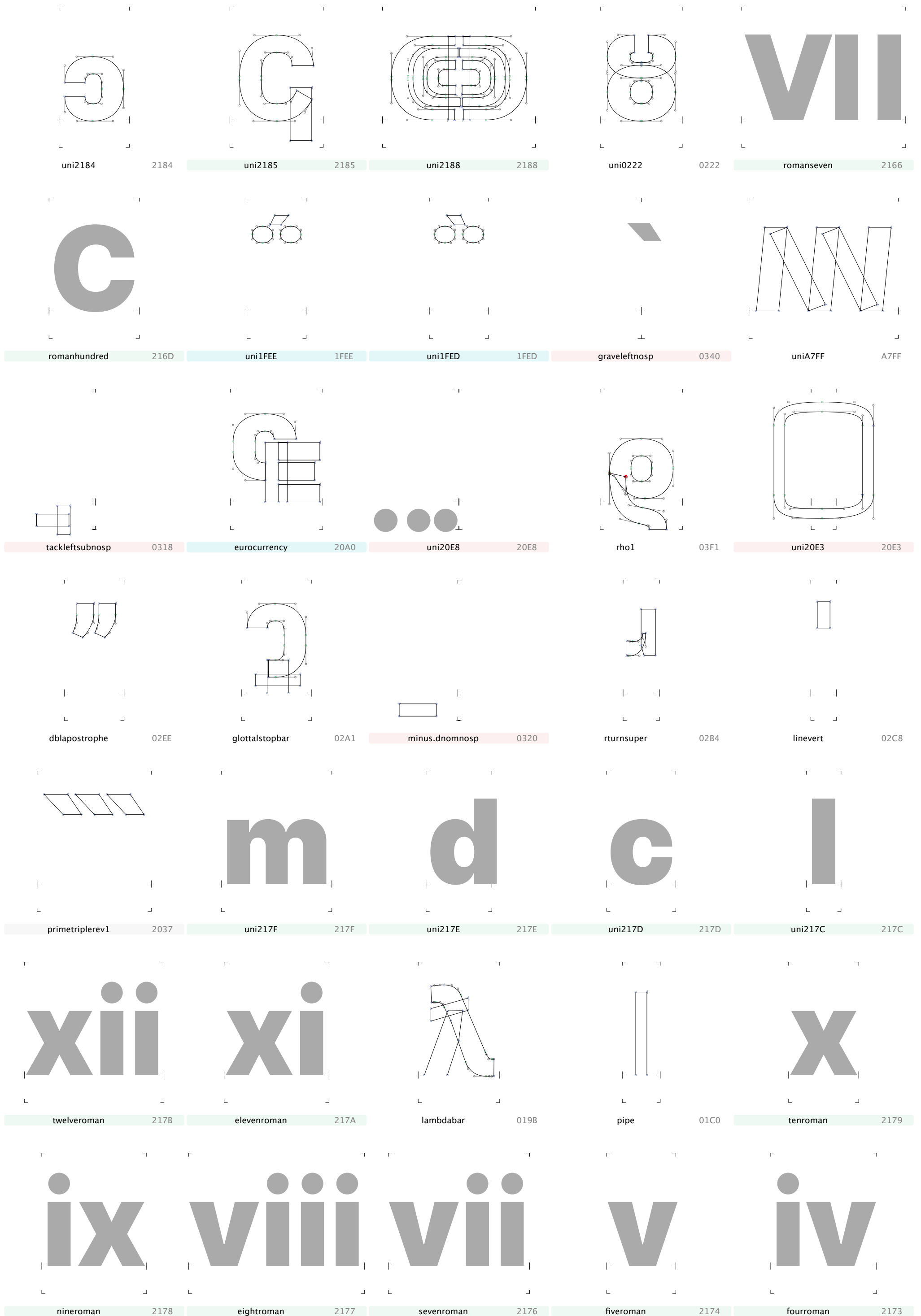

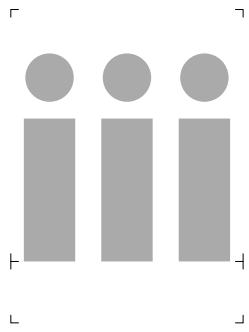

threeroman 2172



tworoman 2171



oneroman 2170

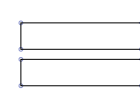

underscoredblensp 0333



tackrightsubnosp 0319

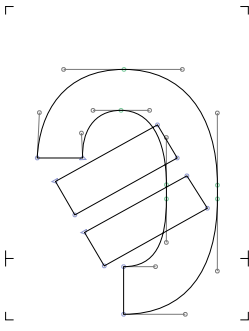

Sampi 03E0



schwa 0259

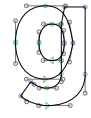

uni1DDA 1DDA

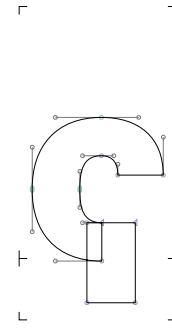

koppacyrillic 0481

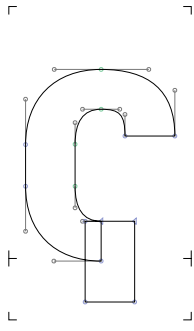

Koppacyrillic 0480

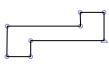

titlocyrlliccmb 0483

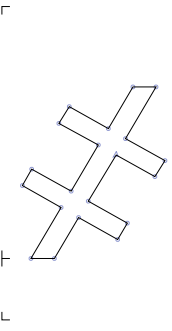

thousandcyrillic 0482



dasiapneumatocyrlliccmb 0485

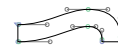

palatalizationcyrlliccmb 0484

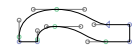

uni0487 0487



psilipneumatocyrlliccmb 0486

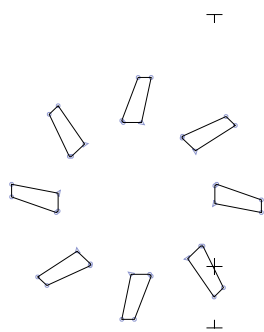

uni0489 0489

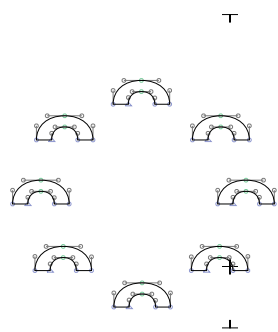

uni0488 0488

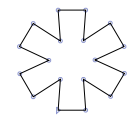

uni20F0 20F0

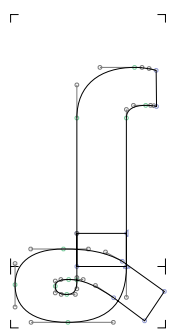

eshcurl 0286



quotereversed 201B

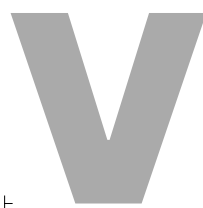

romanfive 2164



uni1FDD 1FDD



uni1FDE 1FDE

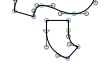

uni1FDF 1FDF

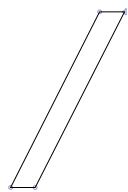

slashshortnosp 0337

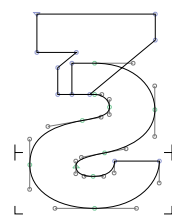

ezhtail 01BA

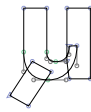

uni1DF0 1DF0

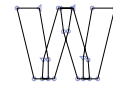

uni1DF1 1DF1

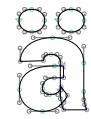

uni1DF2 1DF2

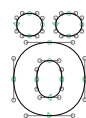

uni1DF3 1DF3

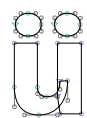

uni1DF4 1DF4



uni1DF5 1DF5



caronbelowcmb 032C



acutesubnosp 0317

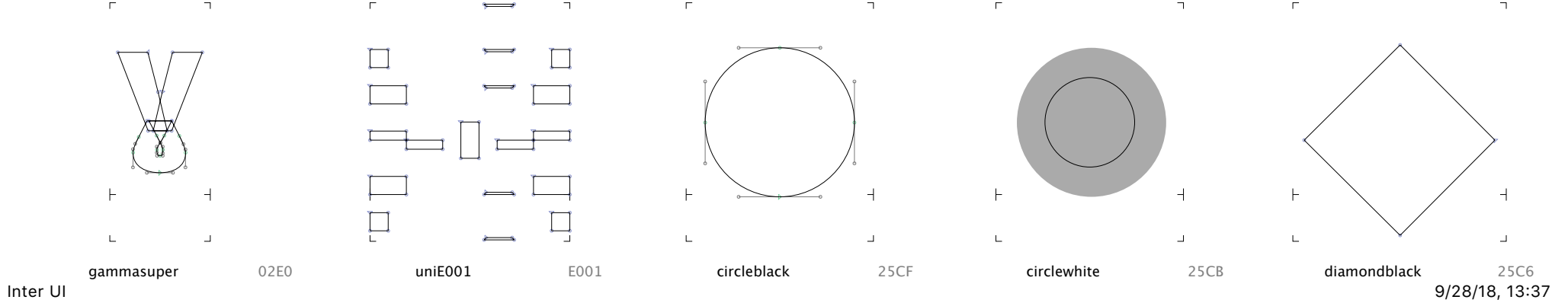
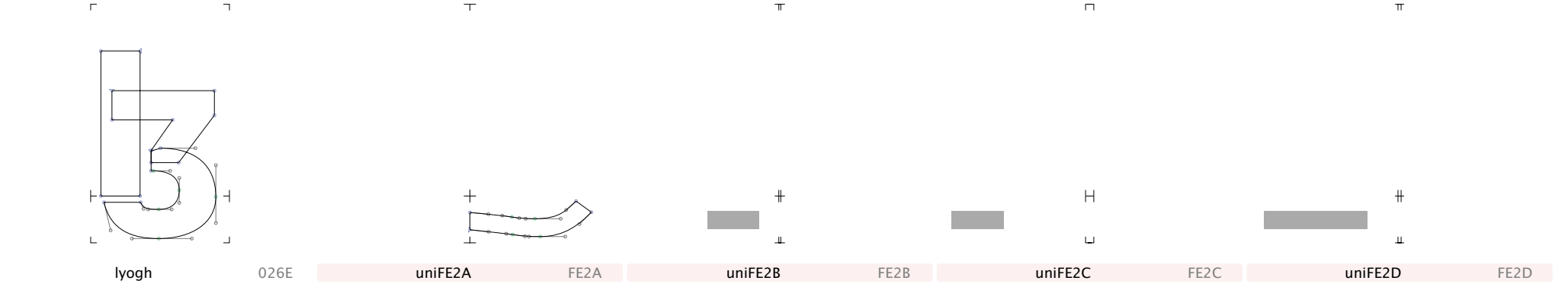
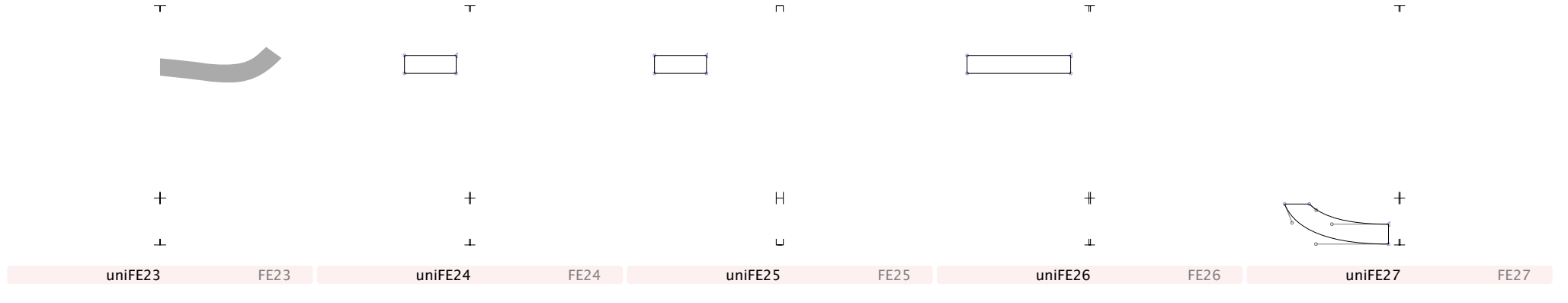
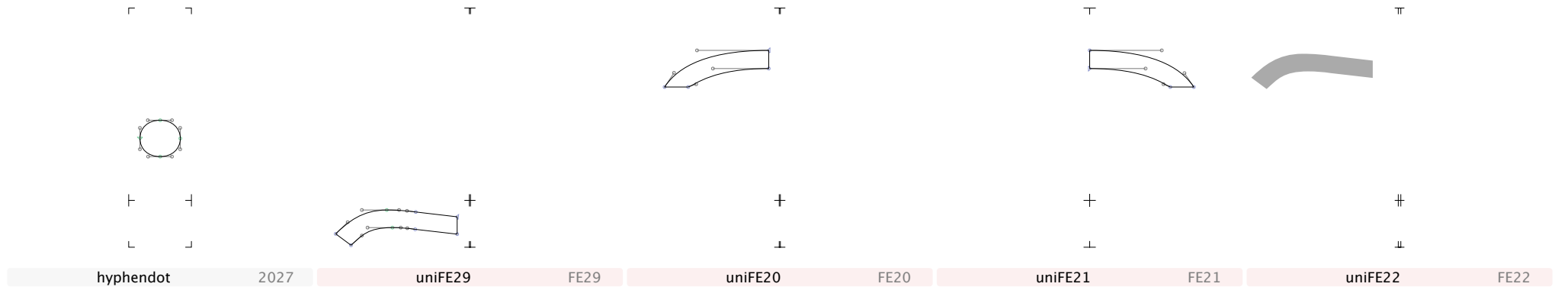
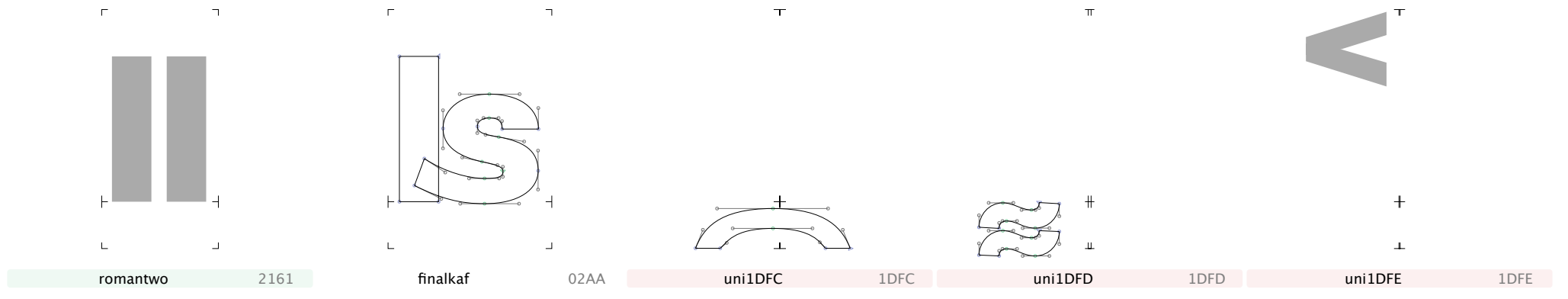

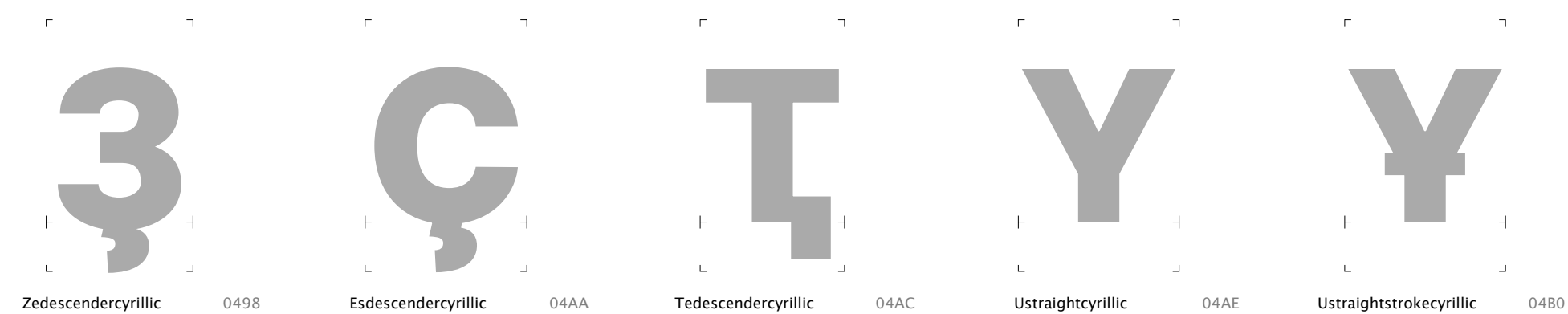
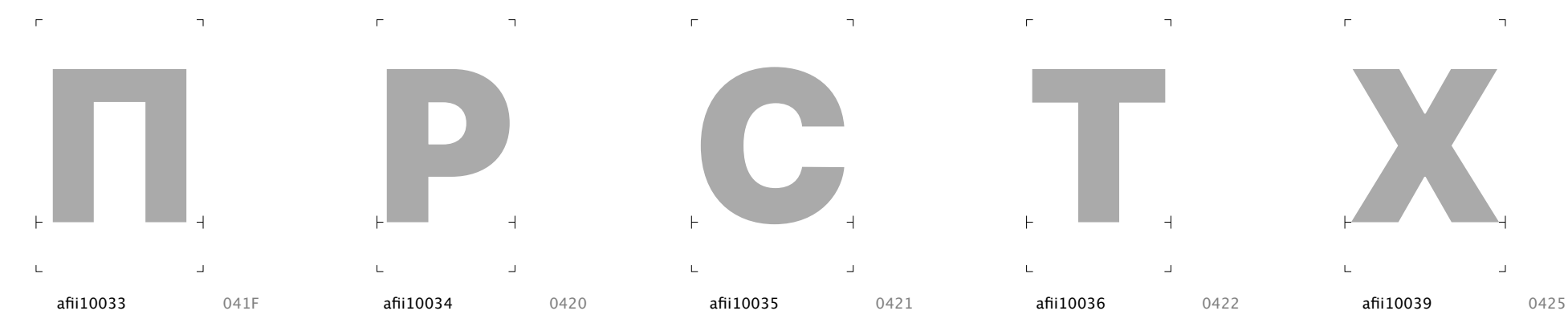
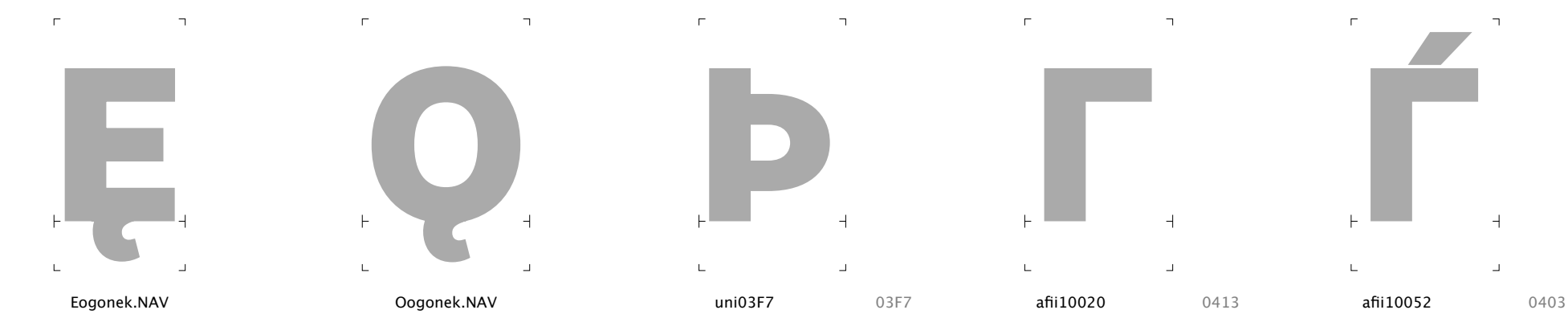
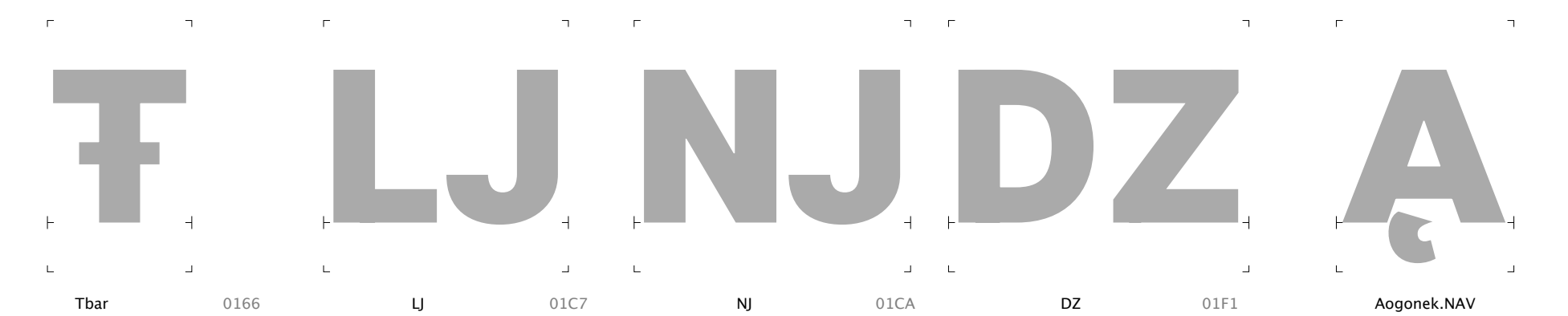
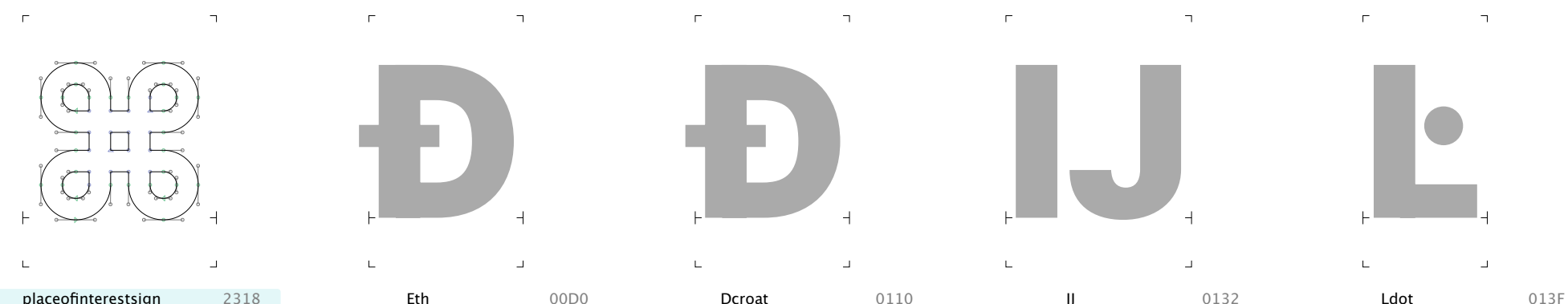
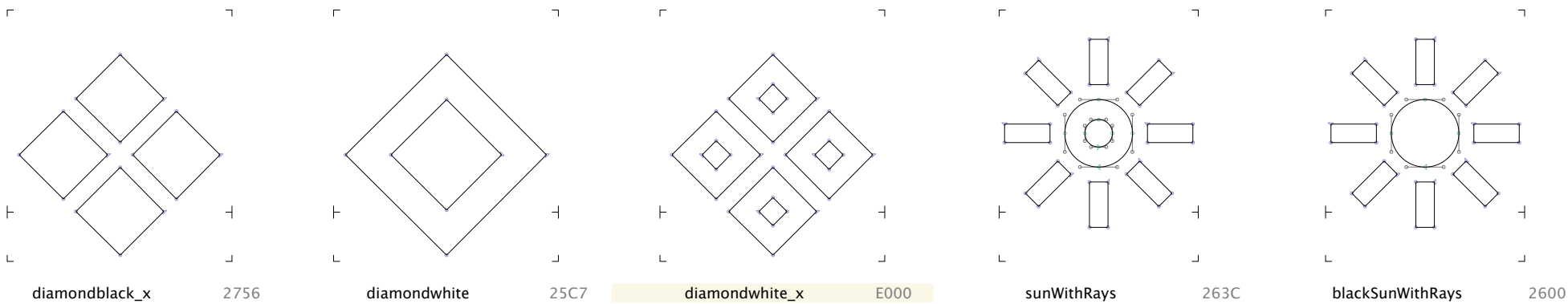

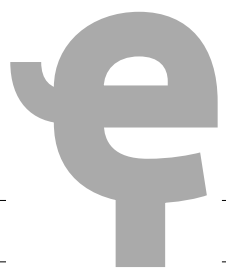

Chedescenderabkhasiancyrillic 04BE



palochkacyrillic 04C0



Chekhakassiancyrillic 04CB



uni04F6 04F6



uni04FE 04FE

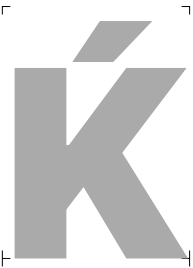

afi10061 040C



Schwadieseriscyrllic 04DA



Zhebrevecyrllic 04C1



Zhedierescyrllic 04DC



Zedierescyrllic 04DE



afi10062 040E



Umacroncyrllic 04EE



Udierescyrllic 04F0



Uhungarumlautcyrllic 04F2



Chedierescyrllic 04F4



Yerudierescyrllic 04F8



uni04EC 04EC



Izhitsadblgravecyrllic 0476



uni0299 0299



uni029C 029C



aogonek.NAV



eogonek.NAV

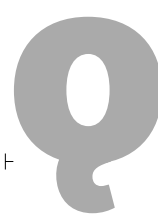

oogonek.NAV



kappa 03BA



mugreek 03BC

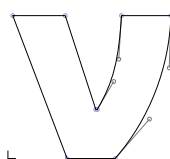

nu 03BD



uni03F8 03F8



uni1F71 1F71



uni1F73 1F73



uni1F75 1F75



uni1F77 1F77



uni1F79 1F79



uni1F7B 1F7B



uni1F7D 1F7D



uni1FD3 1FD3



uni1FE3

1FE3

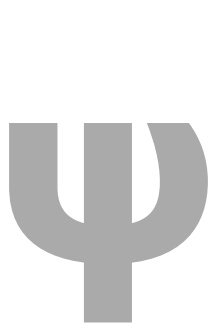

psicyrillic

0471



ghestrokecyrillic

0493



zedescendercyrillic

0499



esdescendercyrillic

04AB

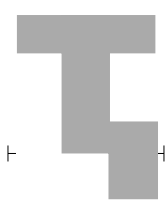

tedescendercyrillic

04AD

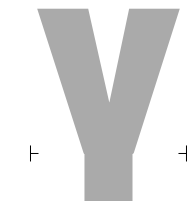

ustraightcyrillic

04AF

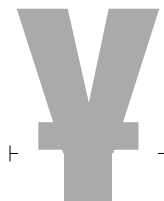

ustraightstrokecyrillic

04B1



chedescenderabkhasiancyrillic

04BF

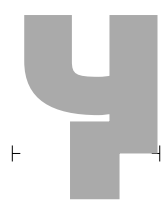

chekhakassiancyrillic

04CC



schwacyrillic

04D9

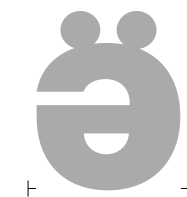

schwadiesiscyrlilic

04DB

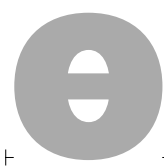

obarredcyrillic

04E9



obarreddierescyrlilic

04EB

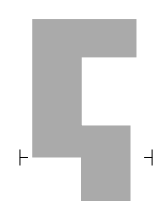

uni04F7

04F7



uni04FF

04FF



chedierescyrlilic

04F5



uni04ED

04ED



gjecyrlilic

0453



iishortcyrlilic

0439



uni045D

045D



imacroncyrlilic

04E3



idierescyrlilic

04E5



izhitsadblgravecyrlilic

0477



kjecyrlilic

045C



yerudierescyrlilic

04F9



zedierescyrlilic

04DF



zhebrevcyrlilic

04C2



zhedierescyrlilic

04DD



Ezhcaron

01EE

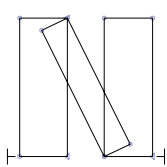

Nsmallcap

0274

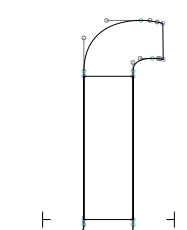

esh

0283

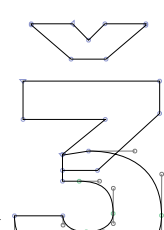

ezhcaron

01EF



pipdbl

01C1

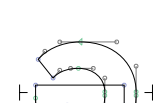

uni2094

2094

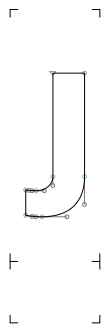

uni02B2.ccmp

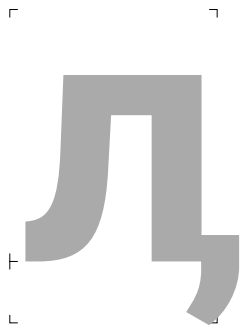

Eltail-cy

04C5

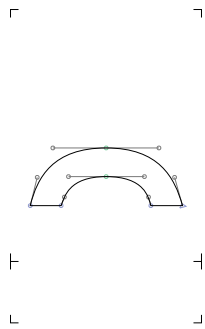

uniA92E

A92E

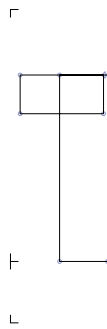

tonebarextrahighmod.cn

02E5

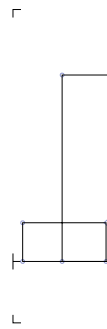

tonebarextralowmod.cn

02E9

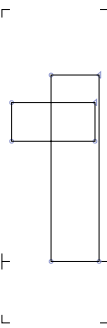

tonebarhighmod.cn

02E6

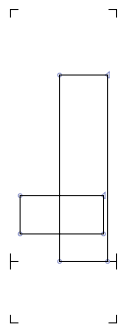

tonebarlowmod.cn

02E8

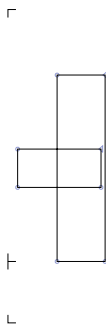

tonebarmidmod.cn

02E7



commaabovecmb

0313



commaaboverightcmb

0315

T

π

π

π

π

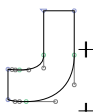

hooksubpalatnosp

0321



bridgeinvsbnosp

033A



uni1DE7

1DE7

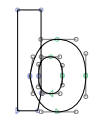

uni1DE8

1DE8



uni1DEA

1DEA

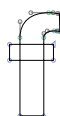

uni1DEB

1DEB

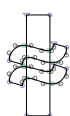

uni1DEC

1DEC

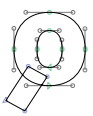

uni1DED

1DED



uni1DEE

1DEE

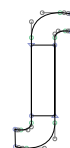

uni1DEF

1DEF

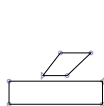

macronacutecomb.cn

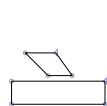

macrongravecomb.cn



uni1FFE.tonos



uni1FCD.tonos



uni1FDD.tonos



uni1FCE.tonos



uni1FDE.tonos



uni1FCF.tonos



uni1FDF.tonos



uni1FEF.tonos



uni1FFD.tonos



uni1DE0

1DE0

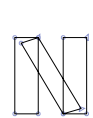

uni1DE1

1DE1



uni1DE3



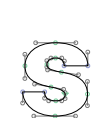







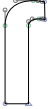

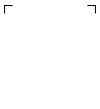

1DE3

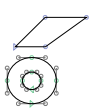
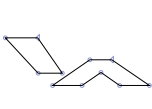
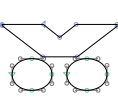
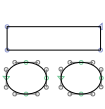
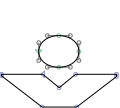
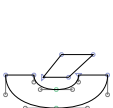
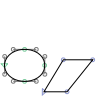
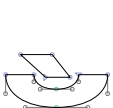
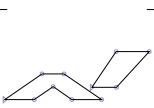
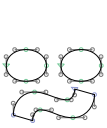
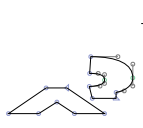
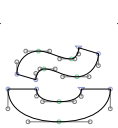
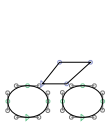
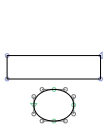
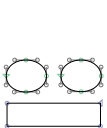

uni1DE4

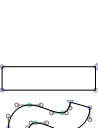
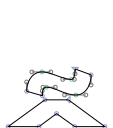
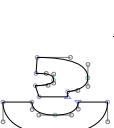
1DE4

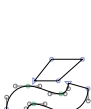
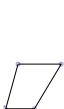
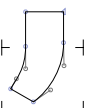

						
uni1DE5	1DE5	uni1DE6	1DE6	cyrillictic.cn	controlHT	controlSOT
						
commaaccentright.cn	ringacute.cn	circumflexgravecomb.cn	dieresiscaroncomb.cn	dieresismacroncomb.cn		
						
carondotcomb.cn	breveacutecomb.cn	acutedotcomb.cn	brevegravecomb.cn	circumflexacutecomb.cn		
						
tildedieresiscomb.cn	circumflexhookcomb.cn	brevetildecomb.cn	dieresisacutecomb.cn	dotmacroncomb.cn		
						
macrondieresiscomb.cn	dieresisgravecomb.cn	tildemacroncomb.cn	circumflextildecomb.cn	brevehookcomb.cn		
						
commaaccentrotate.cn	tildeacutecomb.cn	tonostop	cyrillictail.cn	koronisaccentleft.cn		