

A 0041

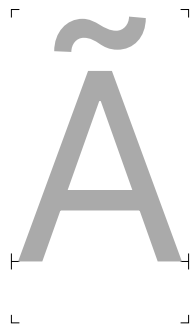

Adieresis 00C4



Atilde 00C3



Agrave 00C0



Aacute 00C1



Acircumflex 00C2

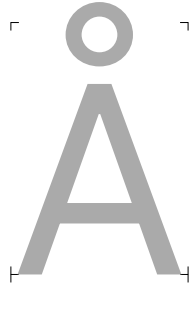

Aring 00C5



Amacron 0100



Abreve 0102



Aogonek 0104

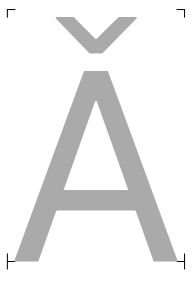

Acaron 01CD



Adieresismacron 01DE

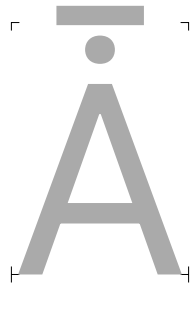

Adotmacron 01E0



Aringacute 01FA



Adblgrave 0200



Ainvertedbreve 0202



uni0226 0226



Aringbelow 1E00



Adotbelow 1EA0



Ahookabove 1EA2



Acircumflexacute 1EA4



Acircumflexgrave 1EA6

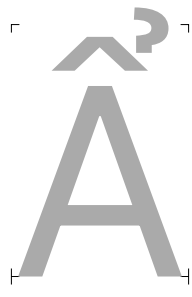

Acircumflexhookabove 1EA8

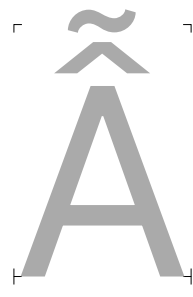

Acircumflextilde 1EAA



Acircumflexdotbelow 1EAC

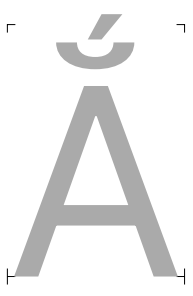

Abreveacute 1EAE



Abrevegrave 1EB0

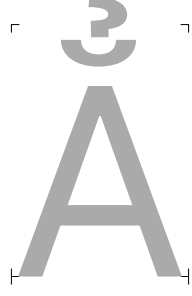

Abrevehookabove 1EB2



Abrevetilde 1EB4

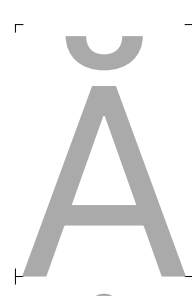

Abrevedotbelow 1EB6



Alpha 0391



Alphatonos 0386



uni1F08 1F08



uni1F09 1F09



uni1F0A 1F0A



uni1F0B

1F0B



uni1F0C

1F0C



uni1F0D

1F0D



uni1F0E

1F0E

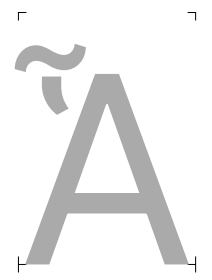

uni1F0F

1F0F

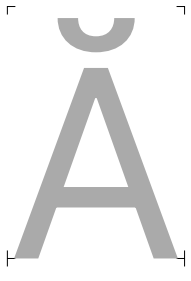

uni1FB8

1FB8



uni1FB9

1FB9



uni1FBA

1FBA

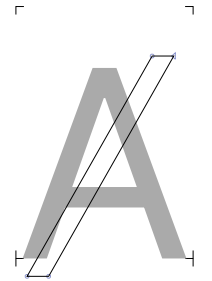

uni023A

023A



uni1FBB

1FBB



afii10017

0410



Abrevcyrillic

04D0



Adieresiscyrillic

04D2



uni1F88

1F88



uni1F89

1F89



uni1F8A

1F8A



uni1F8B

1F8B



uni1F8C

1F8C

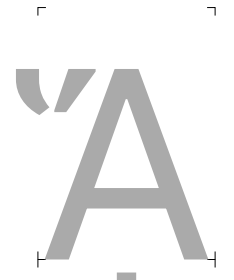

uni1F8D

1F8D



uni1F8E

1F8E



uni1F8F

1F8F



uni1FBC

1FBC

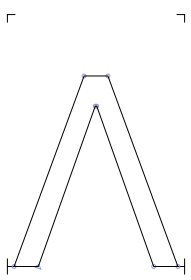

Lambda

039B

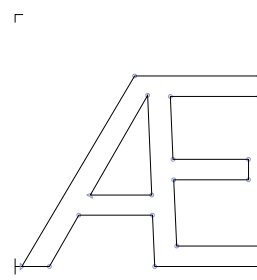

AE

00C6



AEmacron

01E2

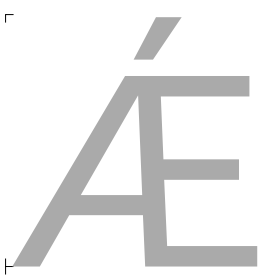

AEacute

01FC



Aiecyrillic

04D4

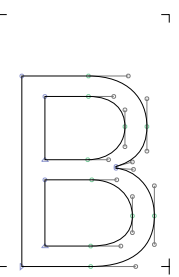

B

0042



Bdotaccent

1E02



Bdotbelow

1E04

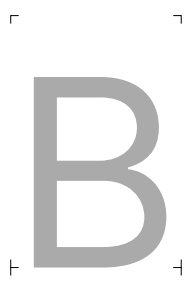

Blinebelow

1E06



uni0243

0243

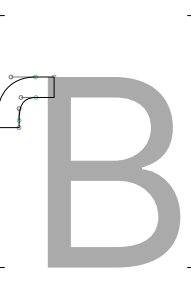

Bhook

0181



afii10019

0412



Beta

0392

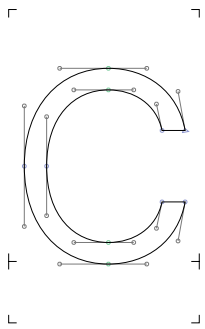

C 0043

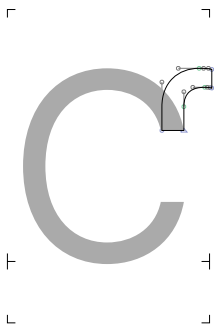

Chook 0187

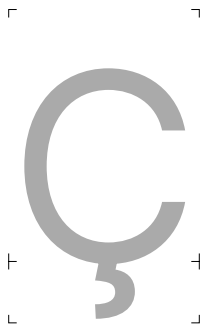

Ccedilla 00C7

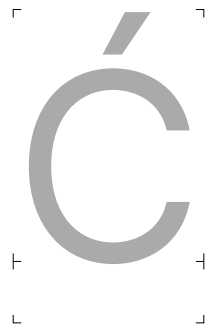

Cacute 0106

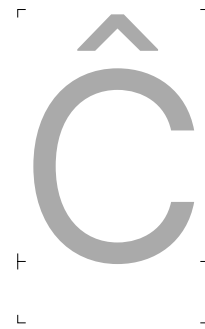

Ccircumflex 0108

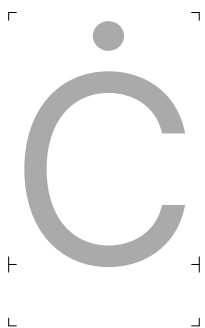

Cdotaccent 010A

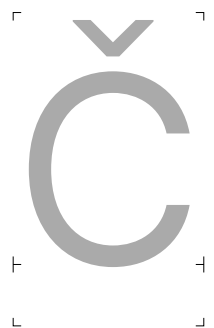

Ccaron 010C

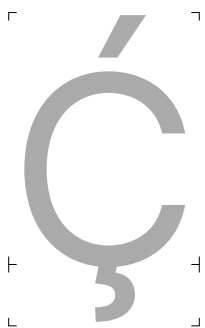

Ccedillaacute 1E08

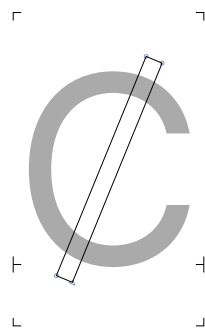

uni023B 023B

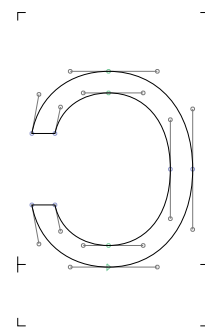

Oopen 0186

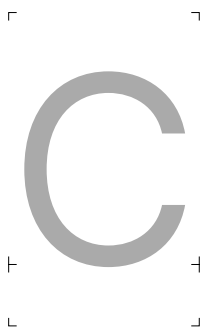

uni03F9 03F9

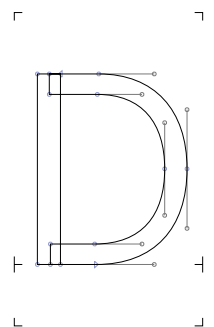

D 0044

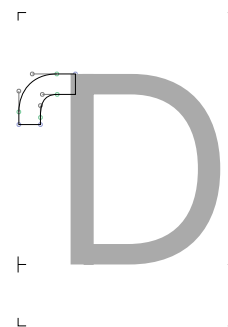

Dhook 018A

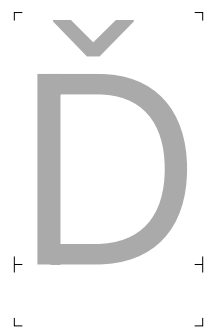

Dcaron 010E



Ddotaccent 1E0A

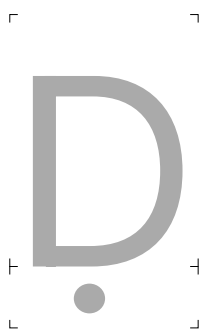

Ddotbelow 1E0C

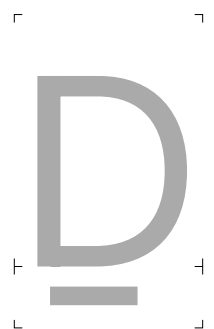

Dlinebelow 1E0E

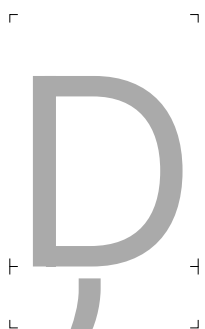

Dcedilla 1E10

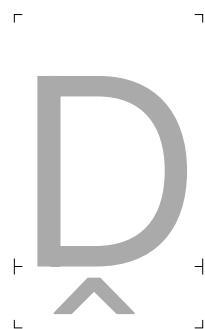

Dcircumflexbelow 1E12

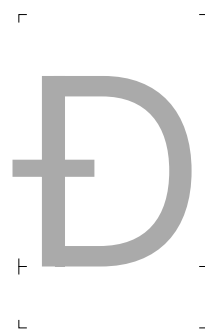

Dbar1 0189



Dz 01F2



Dzcaron\_ 01C5

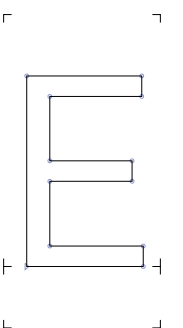

E 0045

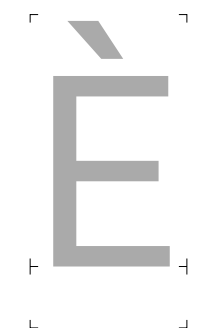

Egrave 00C8

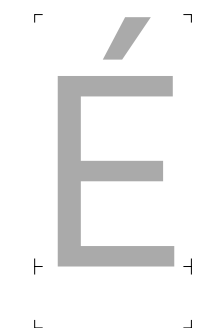

Eacute 00C9

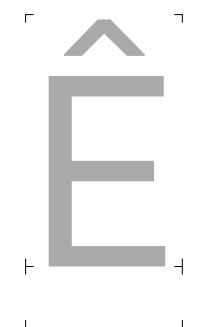

Ecircumflex 00CA

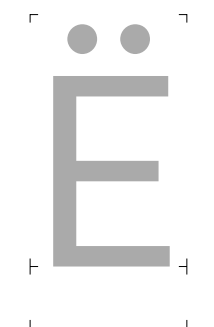

Edieresis 00CB

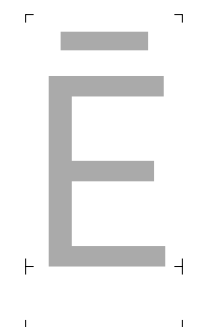

Emacron 0112

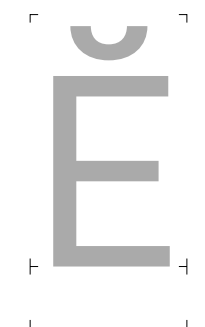

Ebreve 0114

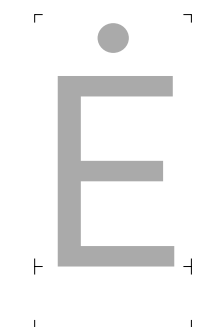

Edotaccent 0116

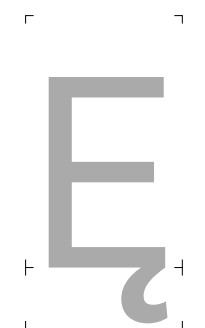

Eogonek 0118

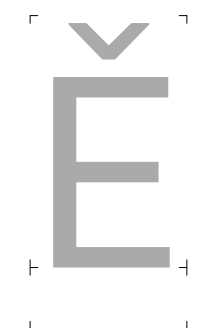

Ecaron 011A

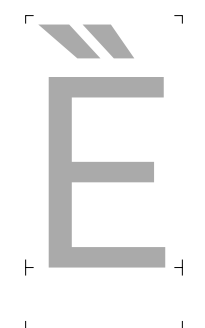

Edblgrave 0204

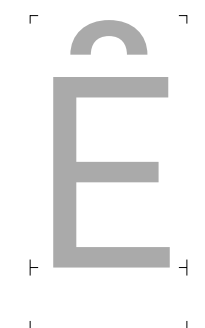

Einvertedbreve 0206

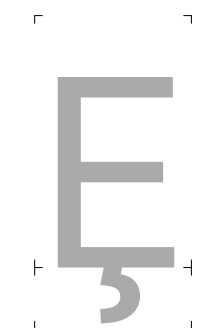

uni0228 0228

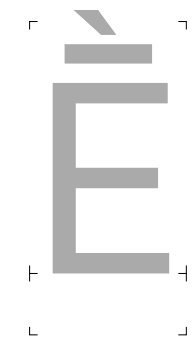

Emacrongrave 1E14



Emacronacute 1E16



Ecircumflexbelow 1E18



Etildebelow 1E1A



Ecedillabreve 1E1C

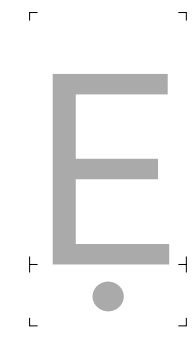

Edotbelow 1EB8



Ehookabove 1EBA



Etilde 1EBC



Ecircumflexacute 1EBE



Ecircumflexgrave 1EC0

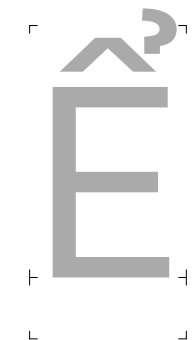

Ecircumflexhookabove 1EC2



Ecircumflextilde 1EC4



Ecircumflexdotbelow 1EC6

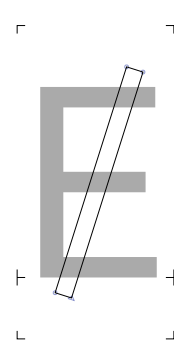

uni0246 0246



Eturn 018E

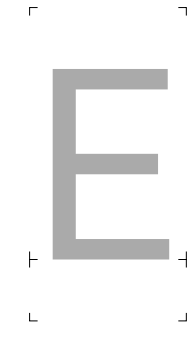

Epsilon 0395



Epsilontonos 0388



uni1F18 1F18



uni1F19 1F19



uni1F1A 1F1A



uni1F1B 1F1B



uni1F1C 1F1C



uni1F1D 1F1D



uni1FC8 1FC8



uni1FC9 1FC9

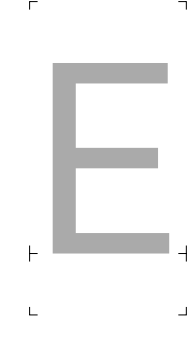

afii10022 0415

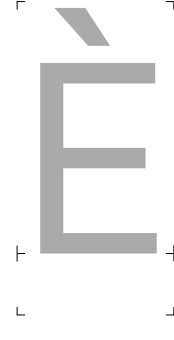

uni0400 0400

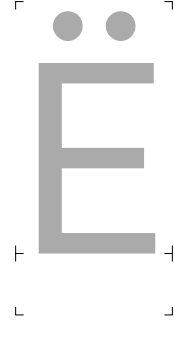

afii10023 0401

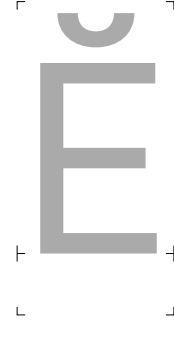

lebrevecyrillic 04D6

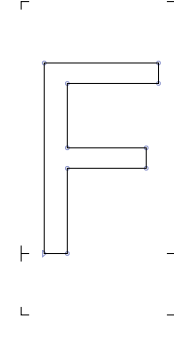

F 0046

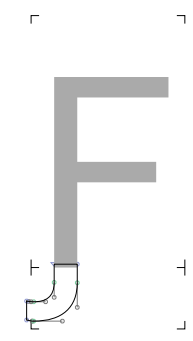

Fhook 0191



Fdotaccent 1E1E

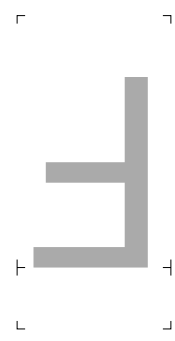

Fturn 2132

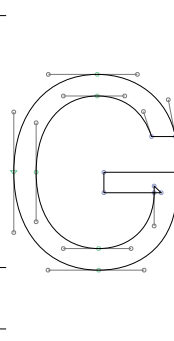

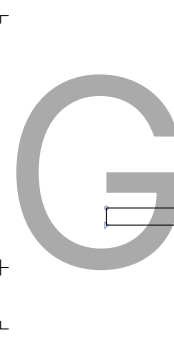

G 0047

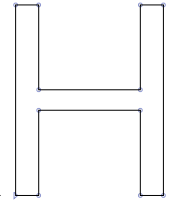

Gbar 01E4

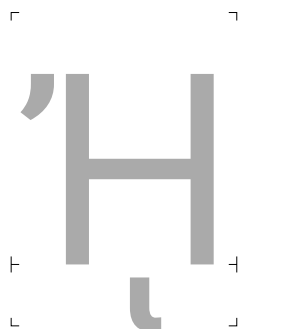
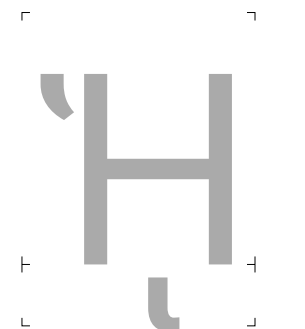
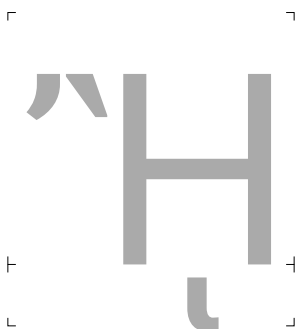
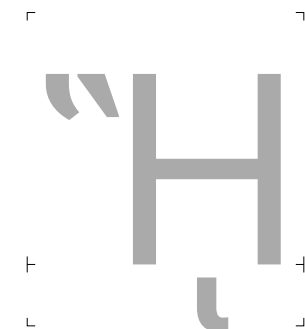
				
Ghook 0193	Gcircumflex 011C	Gbreve 011E	Gdotaccent 0120	Gcommaaccent 0122
				
Gcaron 01E6	Gacute 01F4	Gmacron 1E20	H 0048	Hcedilla 1E28
				
Hcircumflex 0124	uni021E 021E	Hdotaccent 1E22	Hdotbelow 1E24	Hdieresis 1E26
				
Hbrevebelow 1E2A	Hbar 0126	Enhookcyrillic 04C7	Endescendercyrillic 04A2	uni04C9 04C9
				
Enghecyrillic 04A4	uni01F6 01F6	Eta 0397	Eatonos 0389	uni1F28 1F28
				
uni1F29 1F29	uni1F2A 1F2A	uni1F2B 1F2B	uni1F2C 1F2C	uni1F2D 1F2D
				
uni1F2E 1F2E	uni1F2F 1F2F	uni1FCA 1FCA	uni1FCB 1FCB	afii10031 041D

 uni1F98 1F98	 uni1F99 1F99	 uni1F9A 1F9A	 uni1F9B 1F9B	 uni1F9C 1F9C
---	---	--	---	---

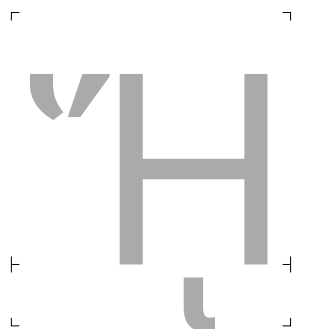
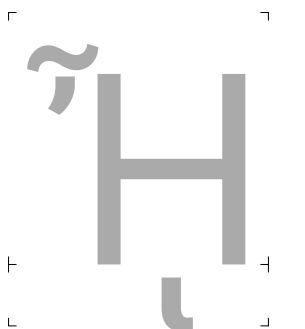
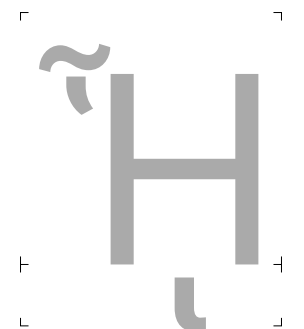
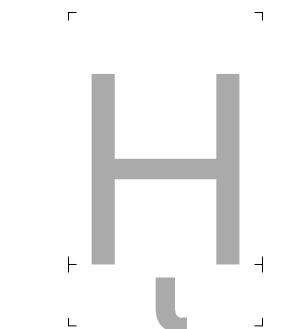
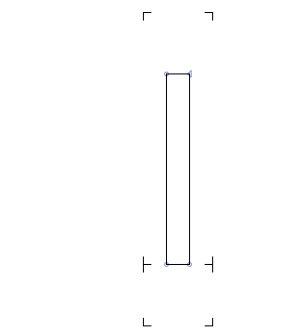
 uni1F9D 1F9D	 uni1F9E 1F9E	 uni1F9F 1F9F	 uni1FCC 1FCC	 0049
---	---	--	---	---

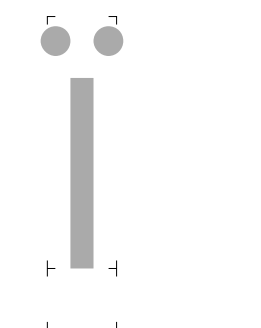
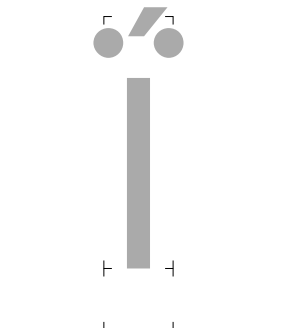
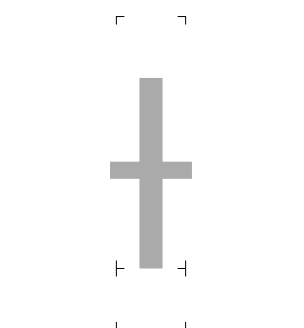
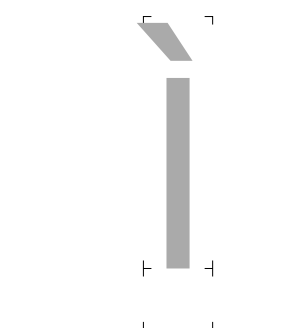
 Idieresis 00CF	 Idieresisacute 1E2E	 Istroke 0197	 Itildebelow 1E2C	 Igrave 00CC
--	---	---	--	---

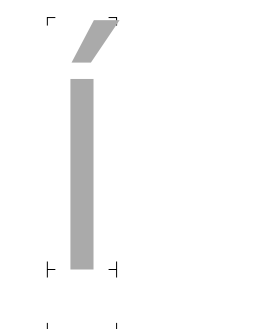
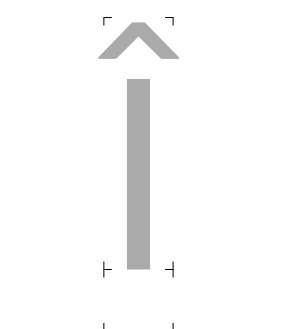
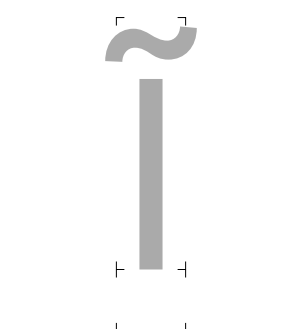
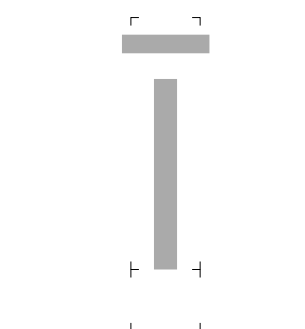
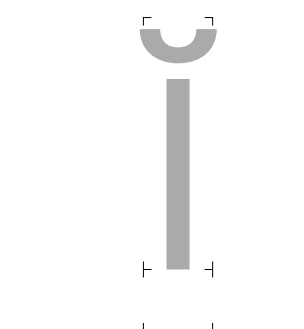
 Iacute 00CD	 Icircumflex 00CE	 Itilde 0128	 Imacron 012A	 Ibreve 012C
--	---	---	---	--

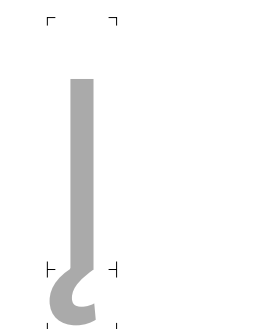
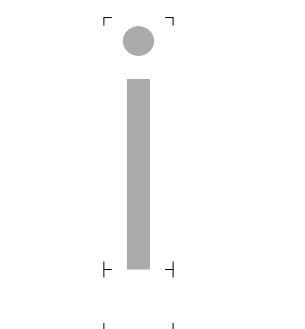
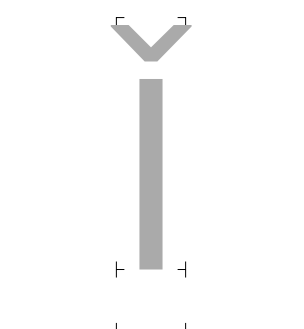
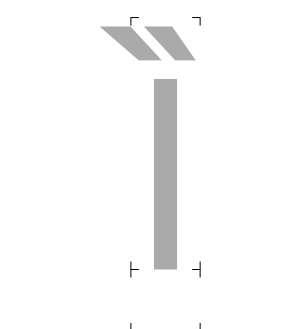
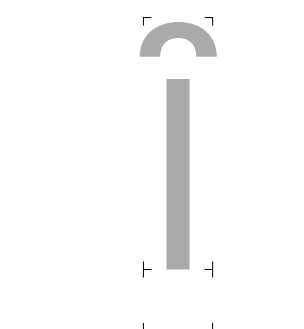
 Iogonek 012E	 Idotaccent 0130	 Icaron 01CF	 Idblgrave 0208	 Iinvertedbreve 020A
---	--	---	---	--

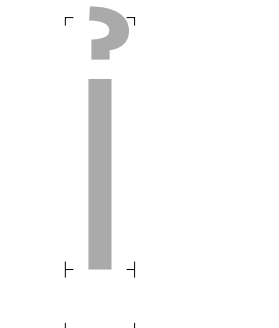
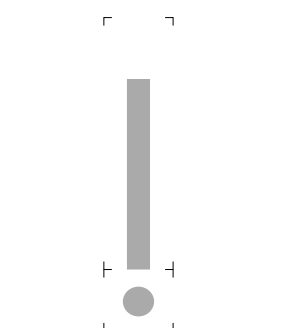
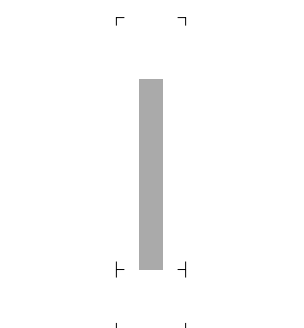
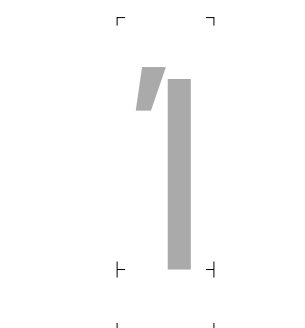
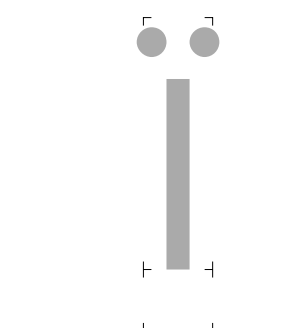
 Ihookabove 1EC8	 Idotbelow 1ECA	 Iota 0399	 Iotatonos 038A	 Iotadieresis 03AA
--	---	---	---	--

 uni1F38 1F38	 uni1F39 1F39	 uni1F3A 1F3A	 uni1F3B 1F3B	 uni1F3C 1F3C
---	---	--	---	---



uni1F3D 1F3D



uni1F3E 1F3E



uni1F3F 1F3F

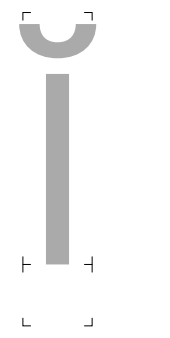

uni1FD8 1FD8



uni1FD9 1FD9

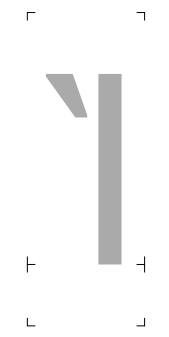

uni1FDA 1FDA



uni1FDB 1FDB

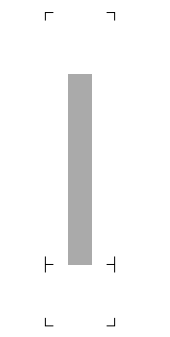

afii10055 0406

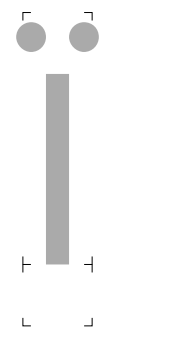

afii10056 0407

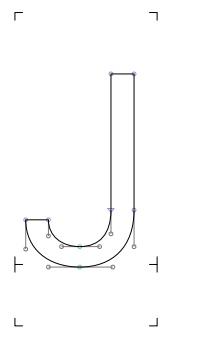

J 004A

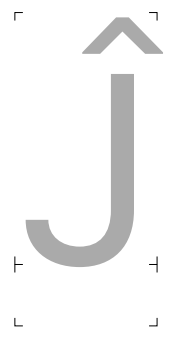

Jcircumflex 0134

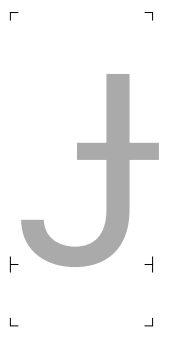

uni0248 0248

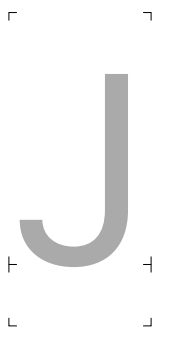

uni037F 037F



afii10057 0408

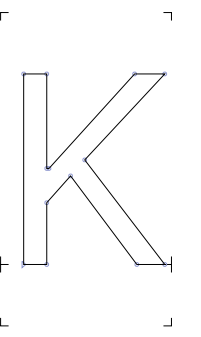

K 004B



Kcommaaccent 0136



Kcaron 01E8



Kacute 1E30



Kdotbelow 1E32

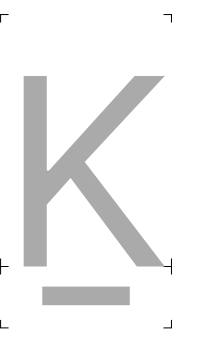

Klinebelow 1E34

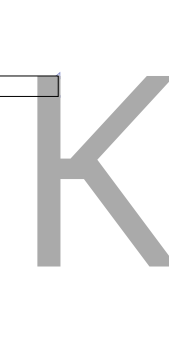

Kabashkircyrillic 04A0

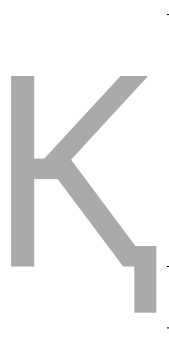

Kadescenderycyrillic 049A

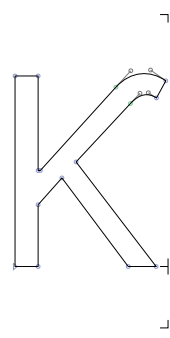

Khook 0198



Kappa 039A

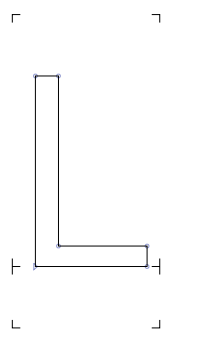

L 004C



Lacute 0139

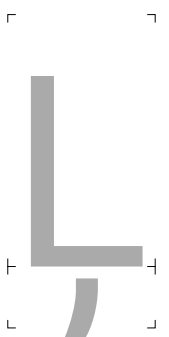

Lcommaaccent 013B



Lcaron 013D



Ldotbelow 1E36

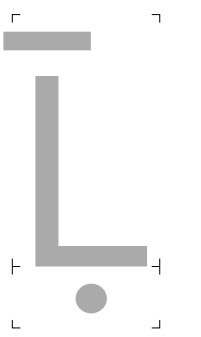

Ldotbelowmacron 1E38



Llinebelow 1E3A



Lcircumflexbelow 1E3C

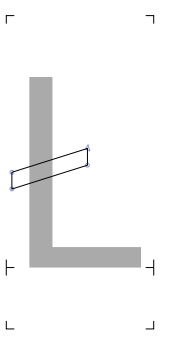

Lslash 0141



Lbar 023D



Lj 01C8

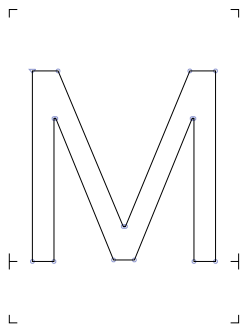

M 004D



Macute 1E3E

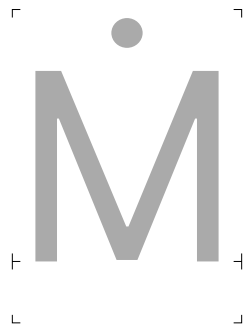

Mdotaccent 1E40

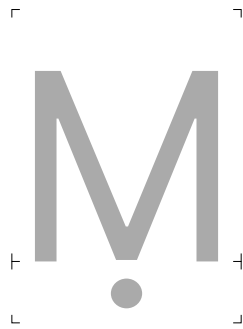

Mdotbelow 1E42



uni04CD 04CD

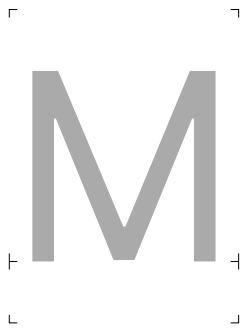

Mu 039C



uni03FA 03FA



afii10030 041C

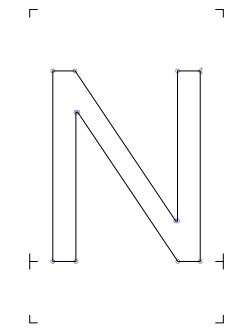

N 004E



Ntilde 00D1



Nacute 0143



Ncommaaccent 0145



Ncaron 0147

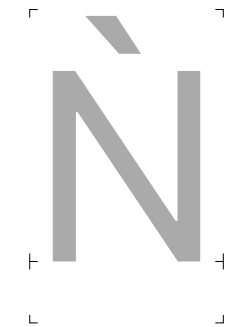

uni01F8 01F8



Ndotaccent 1E44



Ndotbelow 1E46

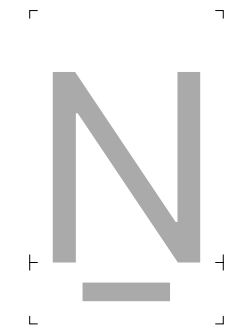

Nlinebelow 1E48



Ncircumflexbelow 1E4A

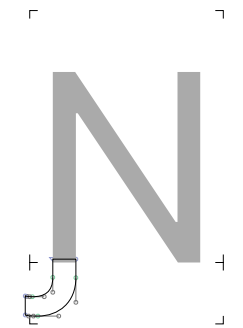

Nhook 019D

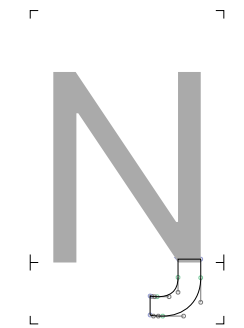

Eng 014A



afii10026 0418

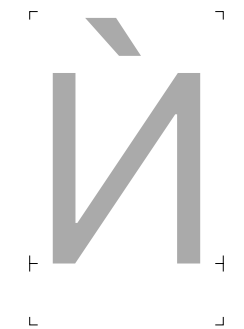

uni040D 040D



afii10027 0419

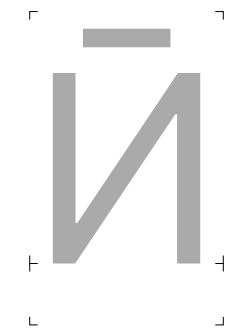

Imacroncyrillic 04E2



Idieresiscyrillic 04E4

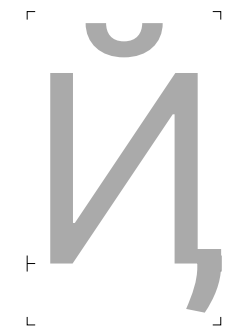

uni048A 048A



uni0376 0376



Nu 039D



Nj 01CB

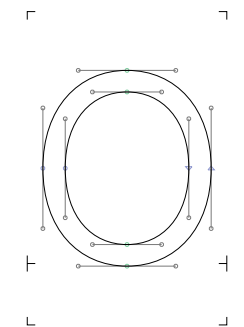

O 004F

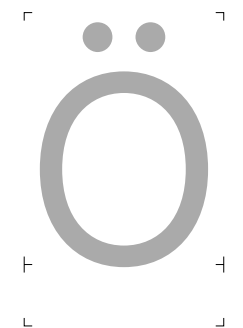

Odiereis 00D6

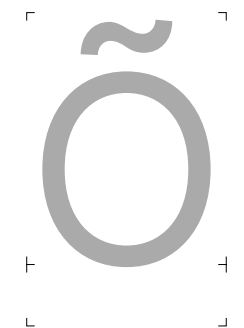

Otilde 00D5

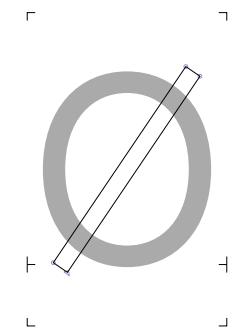

Oslash 00D8

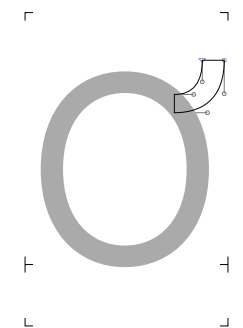



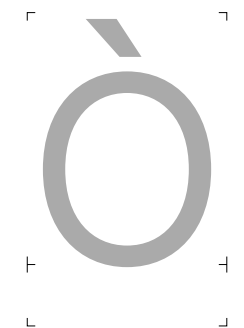





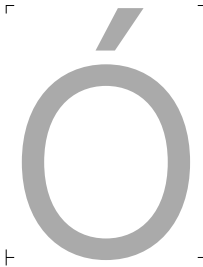
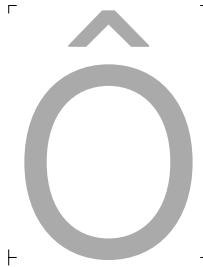
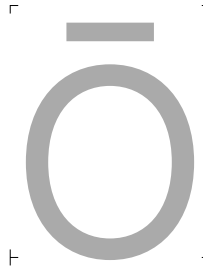
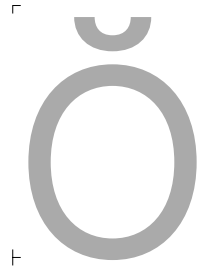

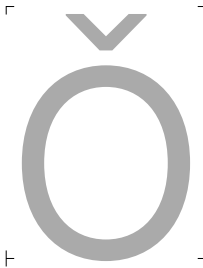
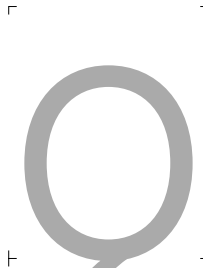
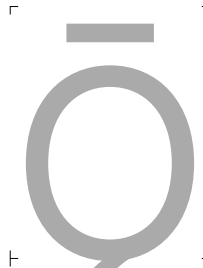
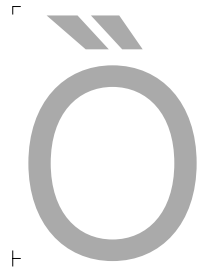

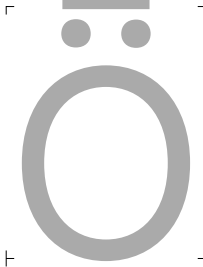

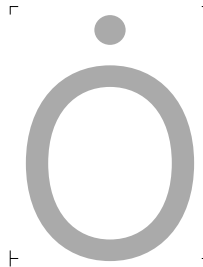
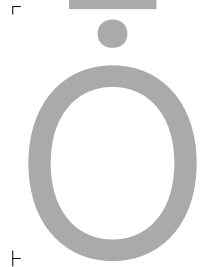
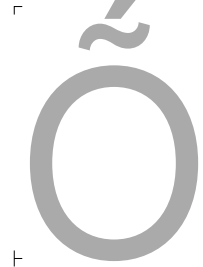
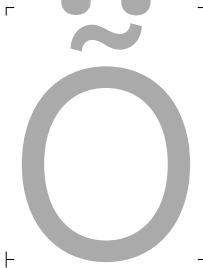
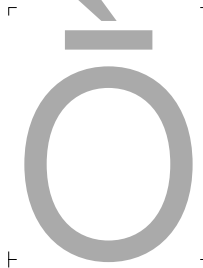
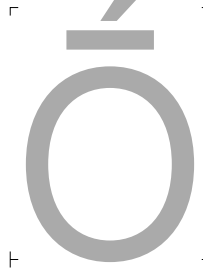
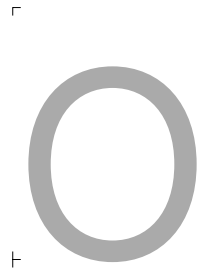
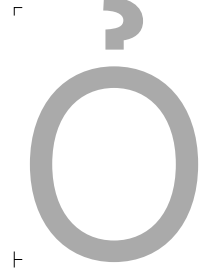
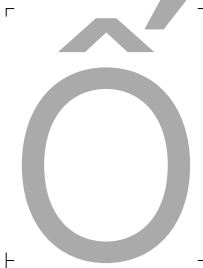
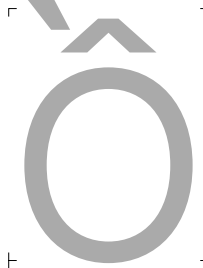
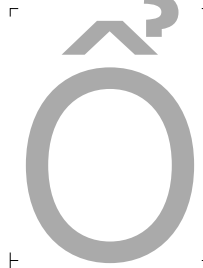
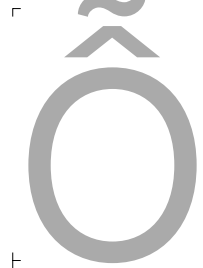
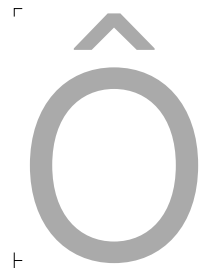

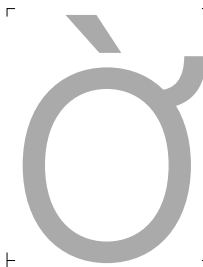
Ohorn 01A0

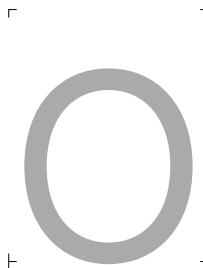

Ograve 00D2



				
Oacute 00D3	Ocircumflex 00D4	Omacron 014C	Obreve 014E	Ohungarumlaut 0150
				
Ocaron 01D1	Oogonek 01EA	Oogonekmacron 01EC	Odblgrave 020C	Oinvertedbreve 020E
				
uni022A 022A	uni022C 022C	uni022E 022E	uni0230 0230	Otildeacute 1E4C
				
Otildedieresis 1E4E	Omacrongrave 1E50	Omacronacute 1E52	Odotbelow 1ECC	Ohookabove 1ECE
				
Ocircumflexacute 1ED0	Ocircumflexgrave 1ED2	Ocircumflexhookabove 1ED4	Ocircumflextilde 1ED6	Ocircumflexdotbelow 1ED8
				
Ohornacute 1EDA	Ohorngrave 1EDC	Ohornhookabove 1EDE	Ohorntilde 1EE0	Ohorndotbelow 1EE2
				
Oslashacute 01FE	Omicron 039F	Omicrontonos 038C	uni1F48 1F48	uni1F49 1F49

uni1F4A 1F4A uni1F4B 1F4B uni1F4C 1F4C uni1F4D 1F4D uni1FF8 1FF8

uni03F4 03F4 uni1FF9 1FF9 afii10032 041E Odieresiscyrillic 04E6 Obar 019F

Obarredcyrillic 04E8 Obarreddieresiscyrillic 04EA OE 0152 P 0050 Pacute 1E54

Pdotaccent 1E56 uni048E 048E Phook 01A4 Rho 03A1 uni1FEC 1FEC

Q 0051 R 0052 Racute 0154 Rcommaaccent 0156 Rcaron 0158

Rdblgrave 0210 Rinvertedbreve 0212 Rdotaccent 1E58 Rdotbelow 1E5A Rdotbelowmacron 1E5C

Rlinebelow 1E5E response 211F Rx 211E uni024C 024C S 0053



Sacute 015A



Scircumflex 015C



Scedilla 015E



Scaron 0160



Scommaaccent 0218



Sdotaccent 1E60



Sdotbelow 1E62



Sacutedotaccent 1E64



Scarondotaccent 1E66



Sdotbelowdotaccent 1E68

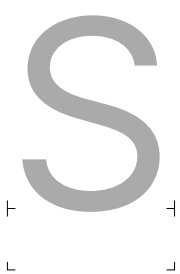

afii10054 0405

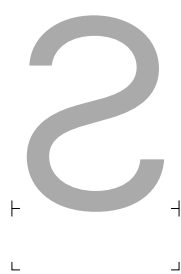

Tonetwo 01A7

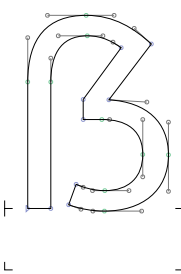

Germandbls 1E9E

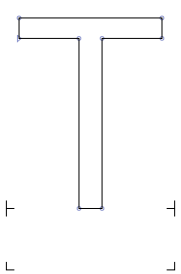

T 0054

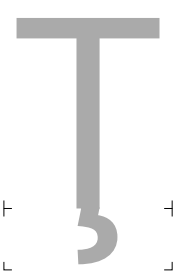

Tcommaaccent 0162



Tcaron 0164

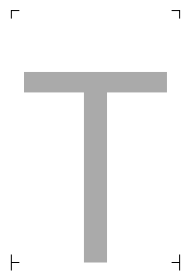

uni021A 021A



Tdotaccent 1E6A

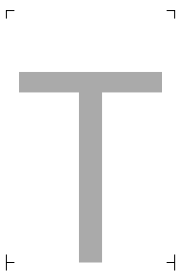

Tdotbelow 1E6C



Tlinebelow 1E6E



Tcircumflexbelow 1E70

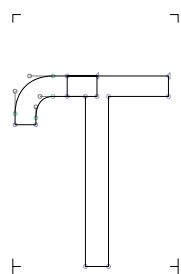

Thook 01AC

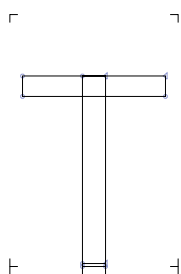

Trhook 01AE

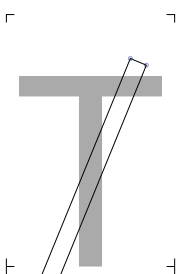

uni023E 023E



Tau 03A4

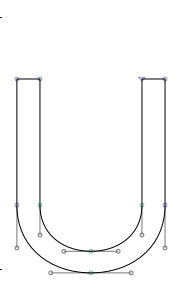

U 0055

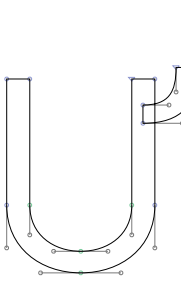

Uhorn 01AF



Ugrave 00D9

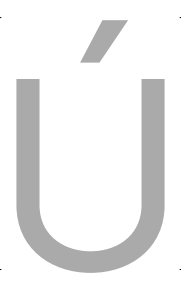

Uacute 00DA

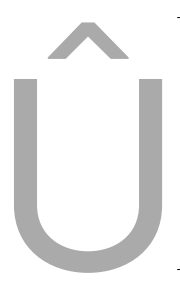

Ucircumflex 00DB

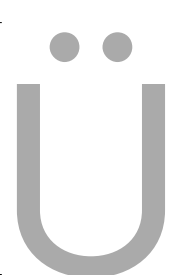

Udieresis 00DC



Utilde 0168

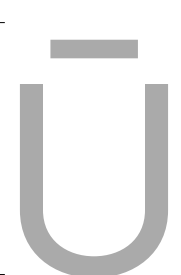

Umacron 016A

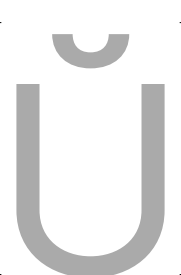

Ubreve 016C

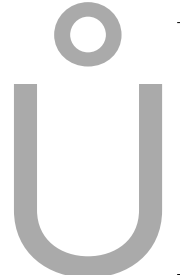

Uring 016E



Uhungarumlaut 0170



Uogonek 0172



Ucaron 01D3



Udieresismacron 01D5



Udieresisacute 01D7

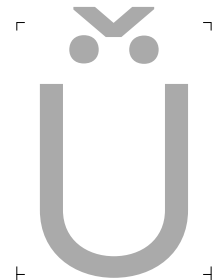

Udieresiscaron 01D9



Udieresisgrave 01DB



Udblgrave 0214



Uinvertedbreve 0216

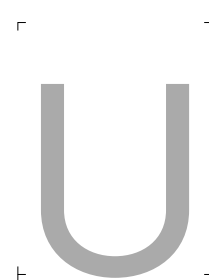

Udieresisbelow 1E72

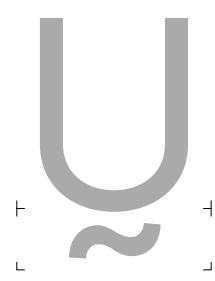

Utildebelow 1E74

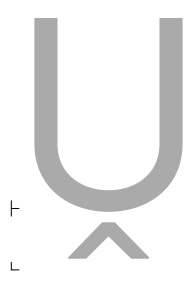

Ucircumflexbelow 1E76



Utildeacute 1E78



Umacrondieresis 1E7A

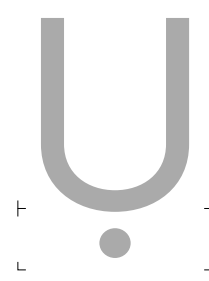

Udotbelow 1EE4

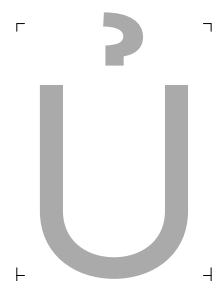

Uhookabove 1EE6



Uhornacute 1EE8



Uhorngrave 1EEA



Uhornhookabove 1EEC



Uhorntilde 1EEE

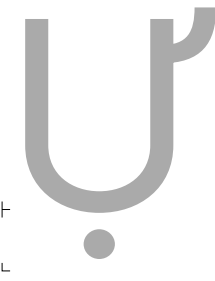

Uhornndotbelow 1EF0

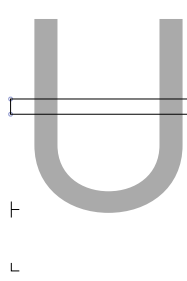

uni0244 0244

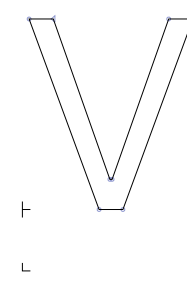

V 0056

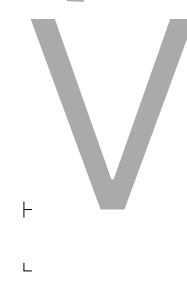

Vtilde 1E7C

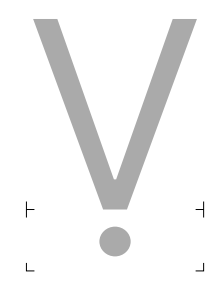

Vdotbelow 1E7E

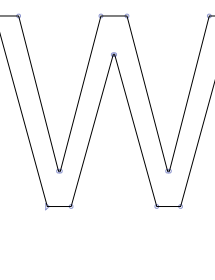

W 0057



Wcircumflex 0174



Wgrave 1E80



Wacute 1E82



Wdieresis 1E84



Wdotaccent 1E86



Wdotbelow 1E88

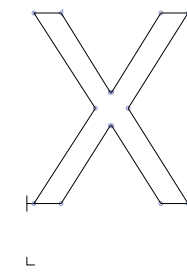

X 0058

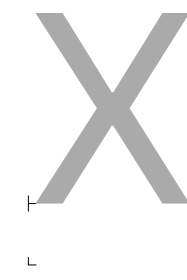

Xdotaccent 1E8A

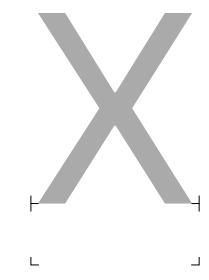

Xdieresis 1E8C

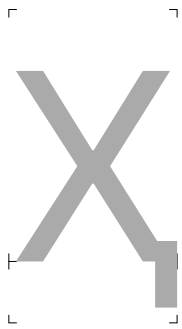

Hascenderycyrillic 04B2

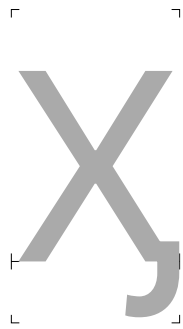

uni04FC 04FC



Chi 03A7

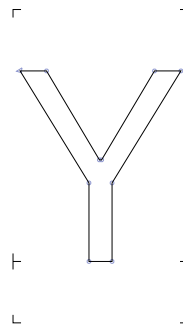

Y 0059

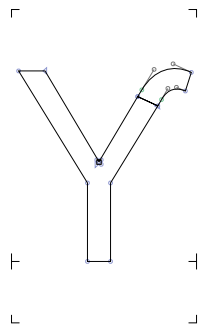

Yhook 01B3



Yacute 00DD

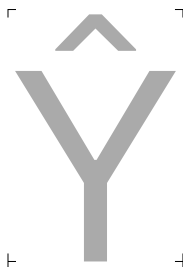

Ycircumflex 0176



Ydieresis 0178

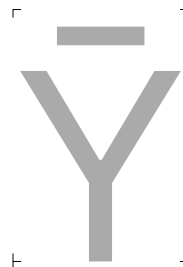

uni0232 0232



Ydotaccent 1E8E



Ygrave 1EF2



Ydotbelow 1EF4



Yhookabove 1EF6



Ytilde 1EF8

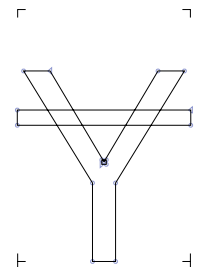

uni024E 024E



Upsilon 03A5



Upsilontonos 038E



Upsilondieresis 03AB

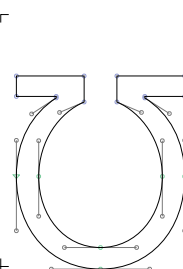

Upsilon2 01B1

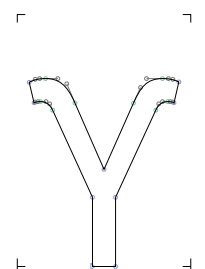

Upsilonhookssymbol 03D2



Upsilonacutehookssymbolgreek 03D3



Upsilondieresishookssymbolgreek 03D4



uni1F59 1F59



uni1F5B 1F5B



uni1F5D 1F5D



uni1F5F 1F5F

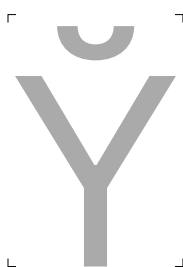

uni1FE8 1FE8



uni1FE9 1FE9



uni1FEA 1FEA



uni1FEB 1FEB

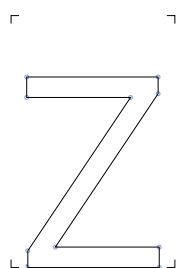

Z 005A



Zacute 0179



Zdotaccent 017B



Zcaron 017D



Zcircumflex 1E90



Zdotbelow 1E92



Zlinebelow 1E94

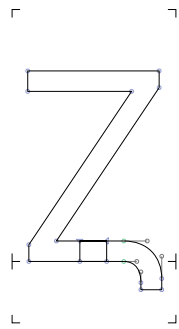

uni0224 0224



Zbar 01B5



Zeta 0396

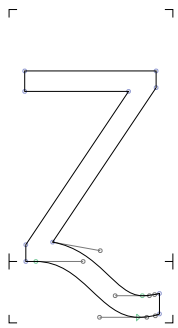

uni2C7F 2C7F

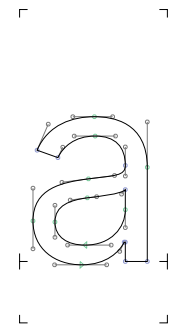

a 0061



adieresis 00E4



atilde 00E3



arighthalfring 1E9A



agrave 00E0



aacute 00E1



acircumflex 00E2



aring 00E5



amacron 0101



abreve 0103



aogonek 0105



acaron 01CE



adieresismacron 01DF



adotmacron 01E1



aringacute 01FB



adblgrave 0201



ainvertedbreve 0203



uni0227 0227



aringbelow 1E01



adotbelow 1EA1



aHOOKabove 1EA3



acircumflexacute 1EA5



acircumflexgrave 1EA7



acircumflexHOOKabove 1EA9



acircumflextilde 1EAB



acircumflexdotbelow 1EAD



abreveacute 1EAF



abrevegrave 1EB1



abreveHOOKabove 1EB3



abrevetilde 1EB5



abrevedotbelow 1EB7



aturn 0250



afii10065 0430



abrevecyrillic 04D1



adieresiscyrillic 04D3

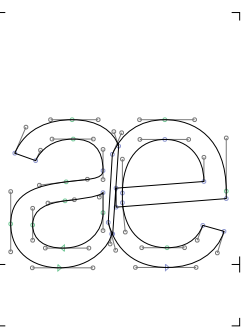

ae 00E6



aemacron 01E3



aeacute 01FD



aiecyrillic 04D5

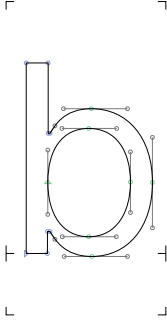

b 0062



bbar 0180

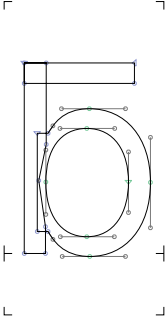

btopbar 0183

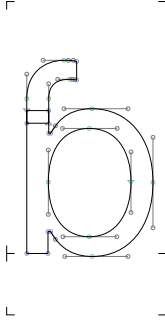

bhook 0253



bdotaccent 1E03



bdotbelow 1E05



blinebelow 1E07

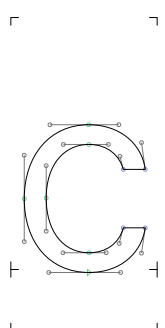

c 0063

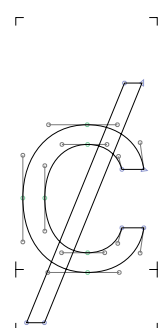

uni023C 023C

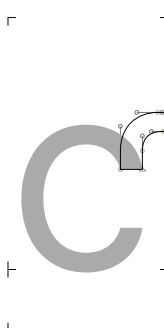

chook 0188

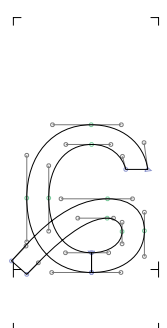

ccurl 0255



ccedilla 00E7



cacute 0107



ccircumflex 0109

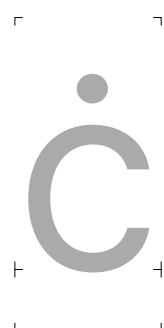

cdotaccent 010B



ccaron 010D



ccedillaacute 1E09



sigmalunatesymbolgreek 03F2



escyrillic 0441



d 0064



dcroat 0111

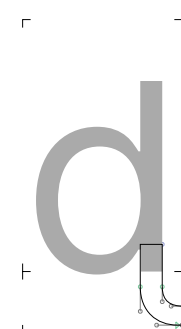

drhook 0256

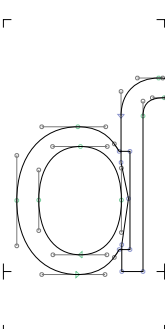

dhook 0257

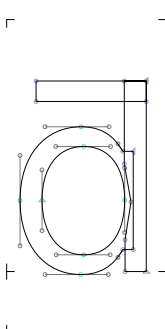

dtopbar 018C

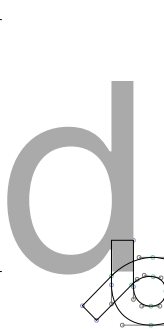

uni0221 0221



dcaron

010F



ddotaccent

1E0B



ddotbelow

1E0D



dlinebelow

1E0F



dcedilla

1E11



dcircumflexbelow

1E13



dz

02A3



dzcaron

01C6



dzcurl

02A5

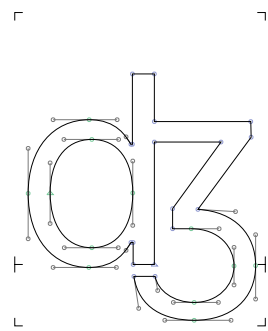

dyogh

02A4



dong

20AB

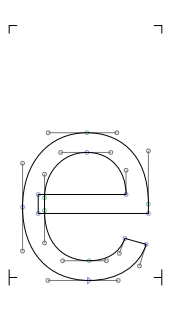

e

0065



edieresis

00EB

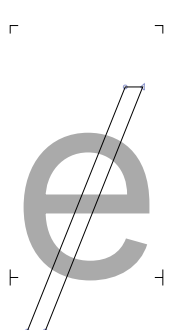

uni0247

0247



egrave

00E8

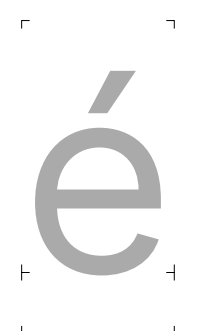

eacute

00E9



ecircumflex

00EA



emacron

0113



ebreve

0115



edotaccent

0117



eogonek

0119



ecaron

011B



edblgrave

0205

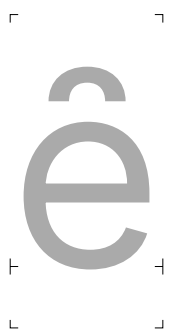

einvertedbreve

0207



uni0229

0229

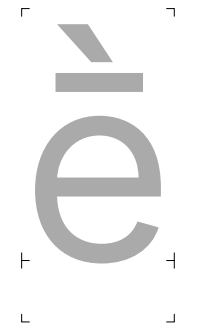

emacrongrave

1E15



emacronacute

1E17



ecircumflexbelow

1E19



etildebelow

1E1B



ecedillabreve

1E1D



edotbelow

1EB9

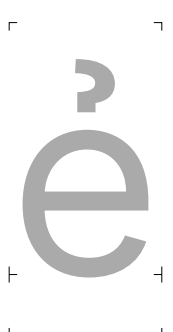

ehookabove

1EBB



etilde

1EBD

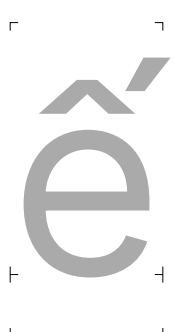

ecircumflexacute

1EBF



ecircumflexgrave

1EC1





ecircumflexhookabove 1EC3



ecircumflexilde 1EC5



ecircumflexdotbelow 1EC7



iecyrillic 0435



uni0450 0450



io Cyrillic 0451



iebrevecyrillic 04D7



eturn 01DD

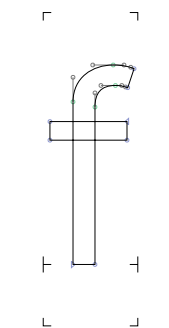

f 0066

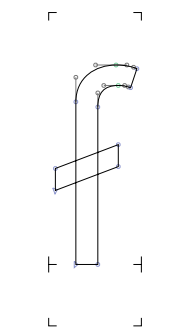

slongstroke 1E9C

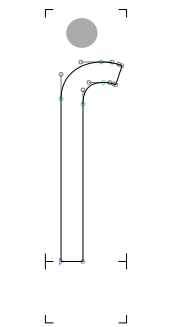

slongdotaccent 1E9B



fdotaccent 1E1F



feng 02A9

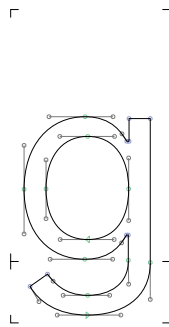

g 0067

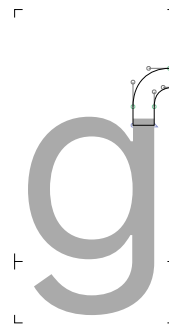

ghook 0260



gbar 01E5



gcircumflex 011D



gbreve 011F



gdotaccent 0121



gcommaaccent 0123



gcaron 01E7



gacute 01F5



gmacron 1E21

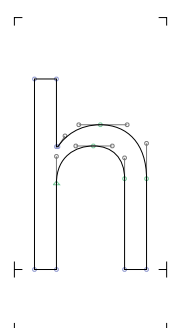

h 0068



hcedilla 1E29



tshevcyrillic 045B

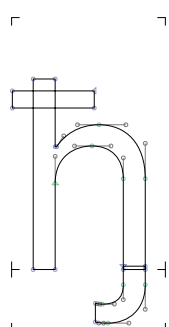

djecyrillic 0452

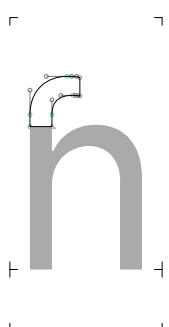

hhook 0266



henghook 0267

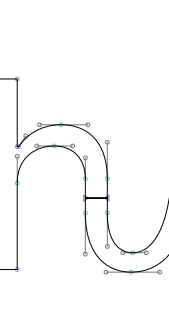

hv 0195



hturn 0265

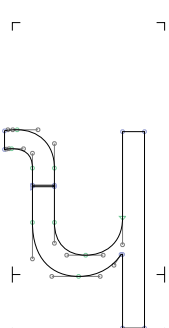

hturnlthook 02AE

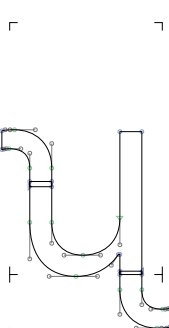

hturnhook2 02AF



hbar 0127



hcircumflex 0125



uni021F

021F



hdotaccent

1E23



hdotbelow

1E25



hdieresis

1E27



hbrevebelow

1E2B



hlinebelow

1E96



shhacryllic

04BB

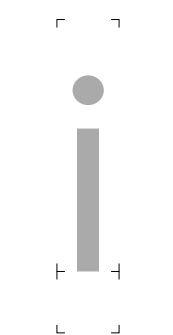

i

0069

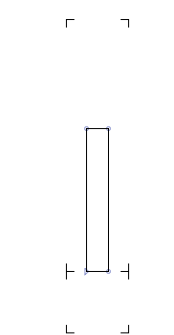

idotless

0131

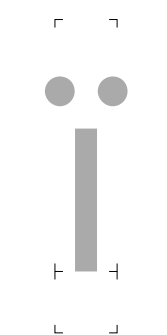

idieresis

00EF

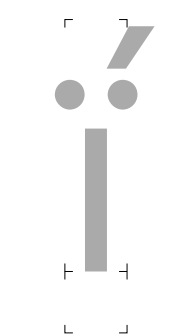

idieresisacute

1E2F



itilde

0129

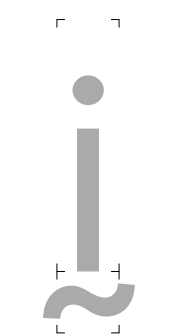

itildebelow

1E2D



uni1E2D.ccmp

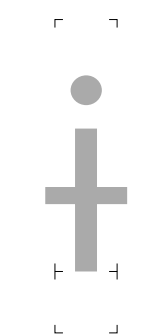

ibar

0268

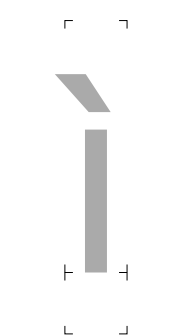

igrave

00EC



iacute

00ED

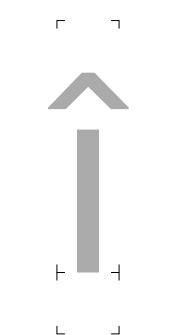

icircumflex

00EE



imacron

012B



ibreve

012D

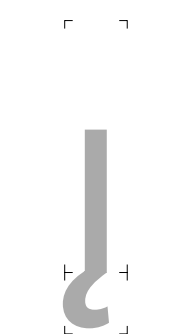

uni012F.ccmp

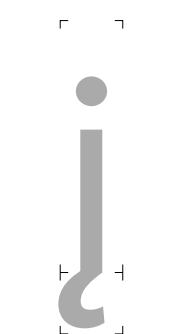

iogonek

012F



icaron

01D0



idblgrave

0209

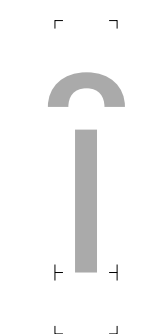

iivertedbreve

020B

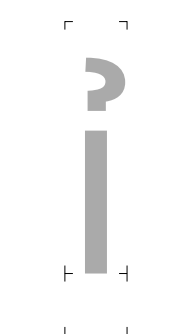

ihookabove

1EC9

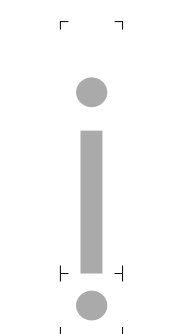

idotbelow

1ECB

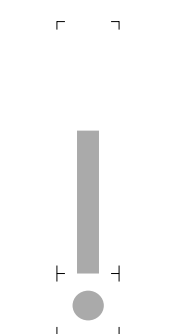

uni1ECB.ccmp

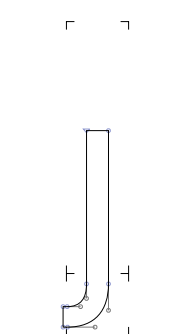

jdotless

0237

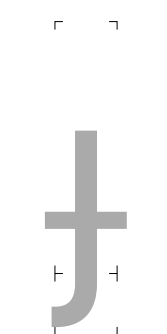

jdotlessbar

025F

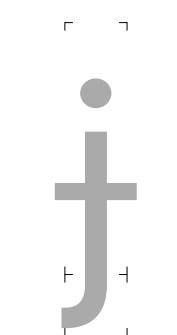

uni0249

0249



uni0249.ccmp

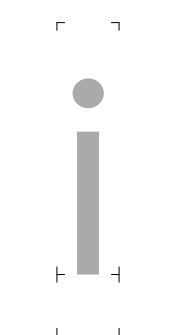

icyrillic

0456

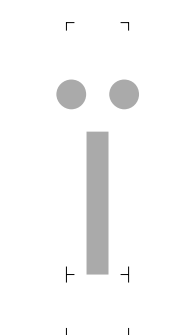





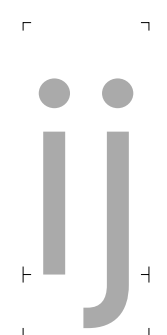













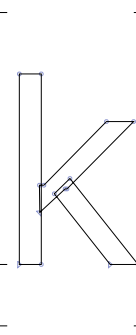
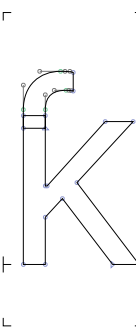





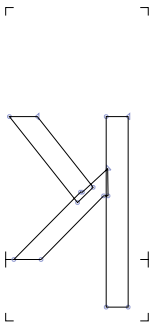

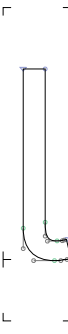
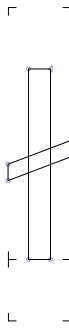
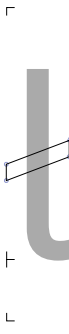
yicyrillic

0457

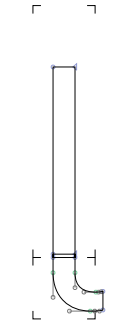
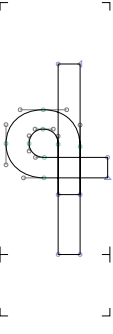
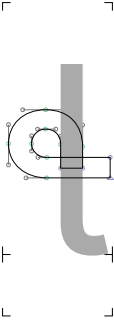
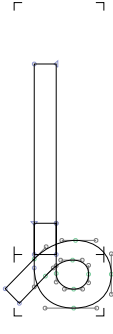

ij

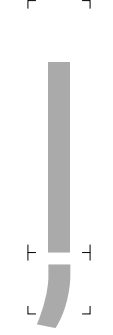
0133

				
j 006A	jcrosstail.ccmp 029D	jcrosstail 029D	jcircumflex 0135	jcaron 01F0
				
yotgreek 03F3	jecyrillic 0458	lj 01C9	k 006B	khook 0199
				
kcommaaccent 0137	kcaron 01E9	kacute 1E31	kdotbelow 1E33	klinebelow 1E35
				
kturn 029E	l 006C	l.ss02	lslash 0142	lslash.ss02
				
tbar 019A	tbar.ss02	lmidtilde 026B	lmidtilde.ss02	lrhook 026D
				
lbelt 026C	lbelt.ss02	lcurl 0234	ldot 0140	ldot.ss02
				
iacute 013A	iacute.ss02	icommaaccent 013C	icommaaccent.ss02	icaron 013E



lcaron.ss02



ldotbelow

1E37



ldotbelow.ss02



ldotbelowmacron

1E39



ldotbelowmacron.ss02



llinebelow

1E3B



llinebelow.ss02



lcircumflexbelow

1E3D



lcircumflexbelow.ss02

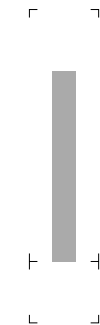

uni04CF

04CF

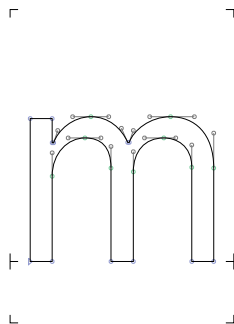

m

006D

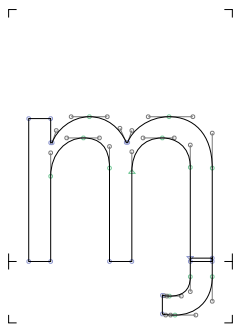

mhook

0271



mturn

026F

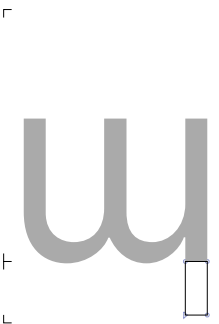

mturndescend

0270

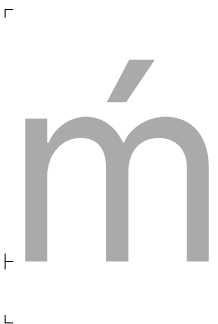

macute

1E3F



mdotaccent

1E41

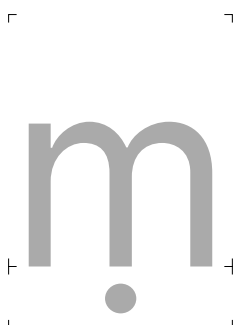

mdotbelow

1E43

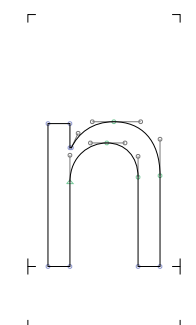

n

006E

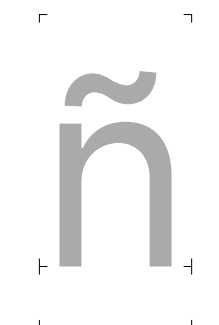

ntilde

00F1

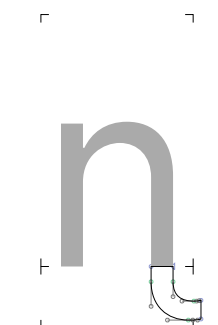

nrthook

0273

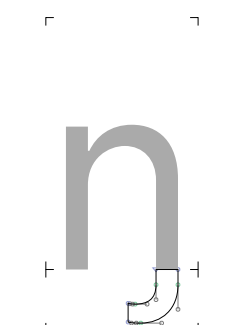

eng

014B

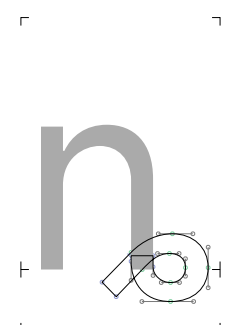

ncurl

0235

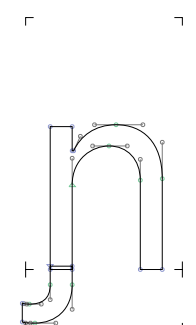

nlfthook

0272

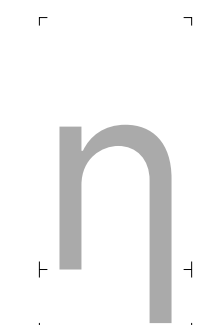

nletrightlong

019E

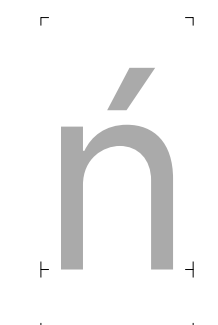

nacute

0144

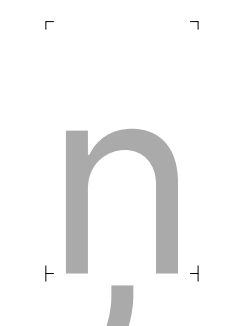

ncommaaccent

0146

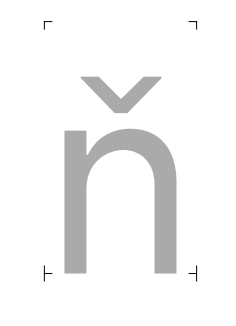

ncaron

0148

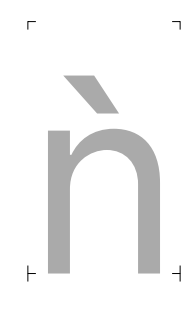

uni01F9

01F9



ndotaccent

1E45

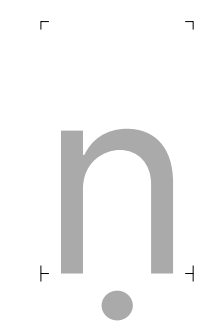

ndotbelow

1E47

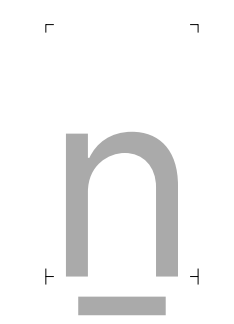

nlinebelow

1E49

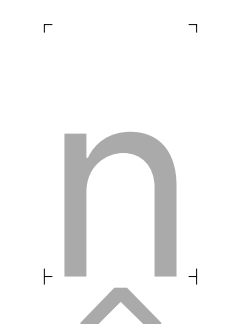

ncircumflexbelow

1E4B



nj

01CC

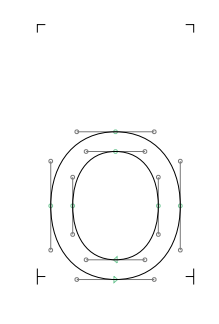











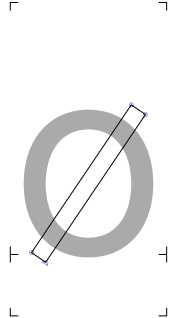
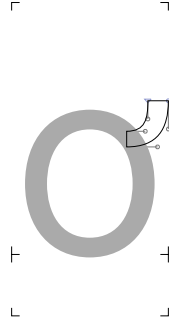

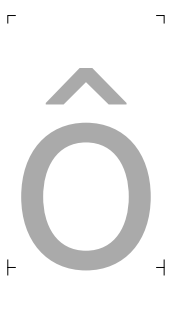

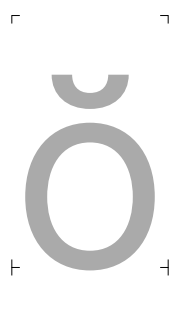

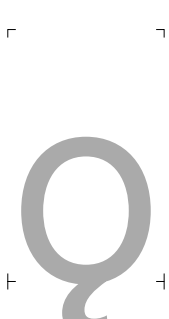



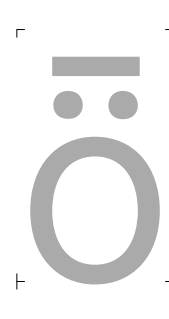

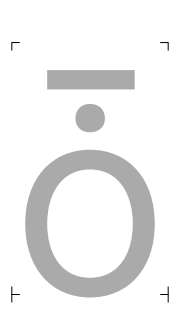

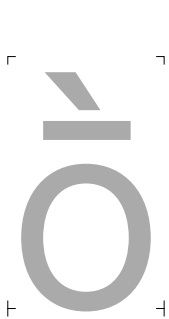

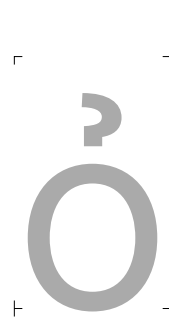

o

006F



odieresis

00F6

				
otilde 00F5	oslash 00F8	ohorn 01A1	ograve 00F2	oacute 00F3
				
ocircumflex 00F4	omacron 014D	obreve 014F	ohungarumlaut 0151	ocaron 01D2
				
oogonek 01EB	oogonekmacron 01ED	odblgrave 020D	oinvertedbreve 020F	uni022B 022B
				
uni022D 022D	uni022F 022F	uni0231 0231	otildeacute 1E4D	otildedieresis 1E4F
				
omacrongrave 1E51	omacronacute 1E53	odotbelow 1ECD	ohookabove 1ECF	ocircumflexacute 1ED1
				
ocircumflexgrave 1ED3	ocircumflexhookabove 1ED5	ocircumflextilde 1ED7	ocircumflexdotbelow 1ED9	ohornacute 1EDB
				
ohorngrave 1EDD	ohornhookabove 1EDF	ohorntilde 1EE1	ohorndotbelow 1EE3	oslashacute 01FF

omeron 03BF omicrontonos 03CC uni1F40 1F40 uni1F41 1F41 uni1F42 1F42

uni1F43 1F43 uni1F44 1F44 uni1F45 1F45 uni1F78 1F78 fitacyrillic 0473

obar 0275 ocyrillic 043E odieresiscyrillic 04E7 oe 0153 ukcyrillic 0479

p 0070 uni048F 048F phook 01A5 pacute 1E55 pdotaccent 1E57

ercyrillic 0440 q 0071 qhook 02A0 qrhook 024B Q\_rhook 024A

r 0072 rrhook 027D uni024D 024D rturn 0279 rturnrhook 027B

rfishhookrev 027F rfishhook 027E rdescend 027C racute 0155 rcommaaccent 0157



rcaron 0159



rdblgrave 0211



rinvetbreve 0213



rdotaccent 1E59



rdotbelow 1E5B



rdotbelowmacron 1E5D



rlinebelow 1E5F

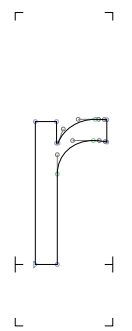

r.1



rrhook.1



uni024D.1



rdescend.1



racute.1



rcommaaccent.1



rcaron.1



rdblgrave.1



rinvetbreve.1



rdotaccent.1



rdotbelow.1



rdotbelowmacron.1



rlinebelow.1

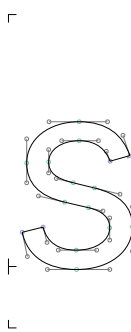

s 0073

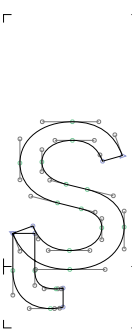

srhook 0282



uni023F 023F



sacute 015B



scircumflex 015D



scedilla 015F



scaron 0161



scommaaccent 0219



sdotaccent 1E61



sdotbelow 1E63



sacutedotaccent 1E65



scarondotaccent 1E67



sdotbelowdotaccent 1E69



dzecyrillic 0455



tonetwo 01A8

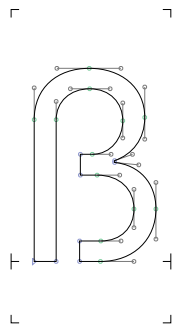

germandbls

00DF

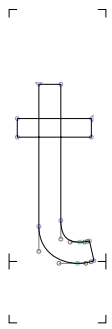

t

0074



tpalatalhook

01AB

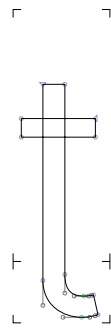

trrhook

0288

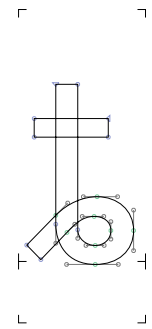

tcurl

0236

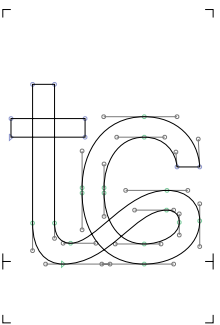

tccurl

02A8



tturn

0287

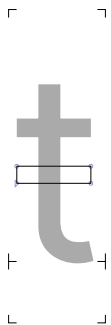

tbar

0167



tcommaaccent

0163



tcaron

0165



uni021B

021B



tdotaccent

1E6B

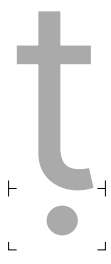

tdotbelow

1E6D



tlinebelow

1E6F

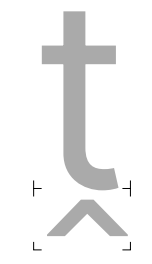

tcircumflexbelow

1E71



tdieresis

1E97

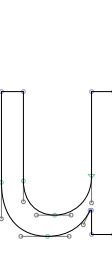

u

0075



udieresis

00FC



utilde

0169

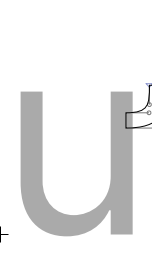

uhorn

01B0

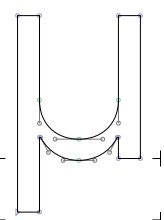

micro

00B5

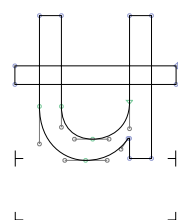

ubar

0289



ugrave

00F9



uacute

00FA



ucircumflex

00FB



umacron

016B



ubreve

016D



uring

016F



uhungarumlaut

0171



uogonek

0173



ucaron

01D4



udieresismacron

01D6



udieresisacute

01D8



udieresiscaron

01DA



udieresisgrave

01DC



udblgrave 0215	uinvertedbreve 0217	udieresisbelow 1E73	utildebelow 1E75	ucircumflexbelow 1E77
utildeacute 1E79	umacrondieresis 1E7B	udotbelow 1EE5	uhookabove 1EE7	uhornacute 1EE9
uhorngrave 1EEB	uhornhookabove 1EED	uhorntilde 1EEF	uhorndotbelow 1EF1	v 0076
vturn 028C	vtilde 1E7D	vdotbelow 1E7F	w 0077	wdieresis 1E85
wturn 028D	wcircumflex 0175	wgrave 1E81	wacute 1E83	wdotaccent 1E87
wdotbelow 1E89	wring 1E98	x 0078	xdotaccent 1E8B	xdieresis 1E8D
khacyrillic 0445	y 0079	ydieresis 00FF	yhook 01B4	uni024F 024F



yacute

00FD



ycircumflex

0177



uni0233

0233



ydotaccent

1E8F



yring

1E99



ygrave

1EF3



ydotbelow

1EF5



yhookabove

1EF7



ytilde

1EF9



ucyrillic

0443



ushortcyrillic

045E



umacroncyrillic

04EF



udieresiscyrillic

04F1



uhungarumlautcyrillic

04F3



yturn

028E

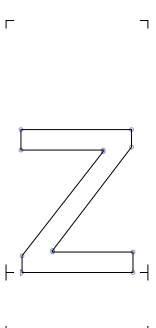

z

007A



zbar

01B6

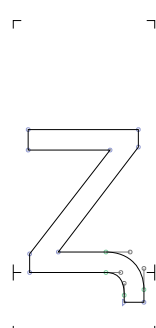

zhook

0225

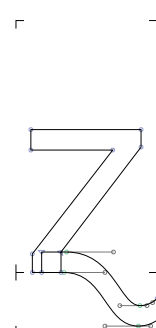

uni0240

0240



zrthook

0290



zacute

017A



zdotaccent

017C



zcaron

017E



zcircumflex

1E91



zdotbelow

1E93



zlinebelow

1E95

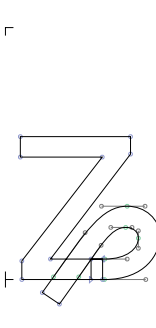

zcurl

0291

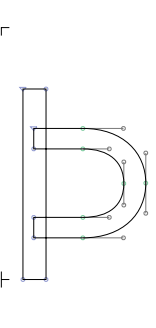

Thorn

00DE

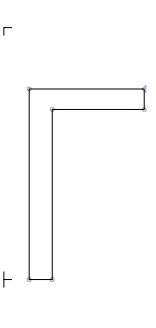

Gamma

0393

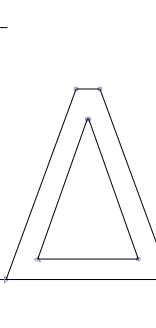

Delta

0394

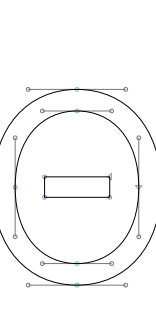

Theta

0398

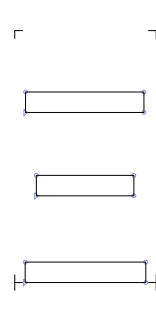

Xi

039E

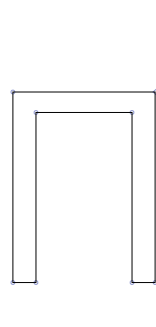

Pi

03A0

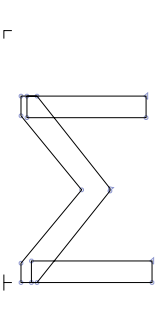

Sigma

03A3

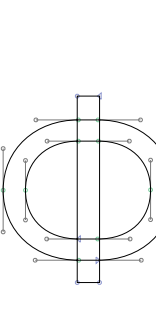

Phi

03A6

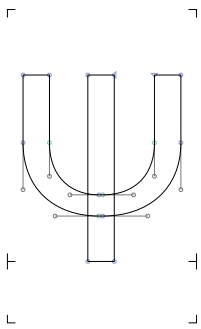

Psi 03A8

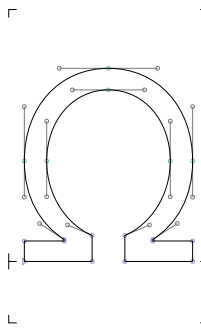

Omega 03A9

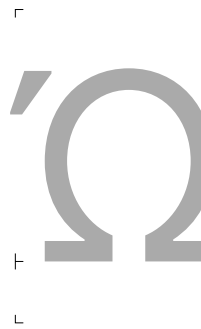

uni1FFB 1FFB



Omegatonos 038F

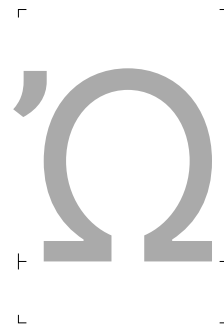

uni1F68 1F68

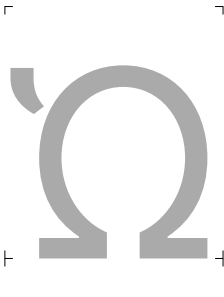

uni1F69 1F69



uni1F6A 1F6A

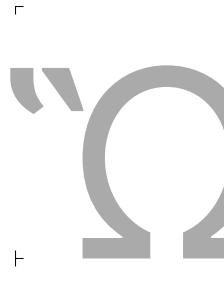

uni1F6B 1F6B



uni1F6C 1F6C



uni1F6D 1F6D

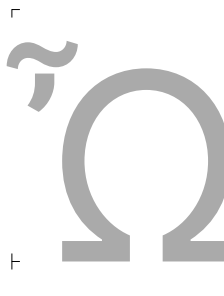

uni1F6E 1F6E

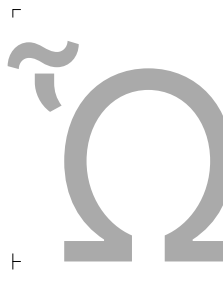

uni1F6F 1F6F



uni1FFA 1FFA



uni1FA8 1FA8

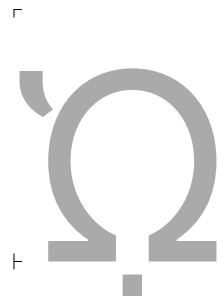

uni1FA9 1FA9



uni1FAA 1FAA



uni1FAB 1FAB



uni1FAC 1FAC



uni1FAD 1FAD



uni1FAE 1FAE

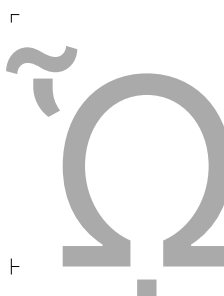

uni1FAF 1FAF

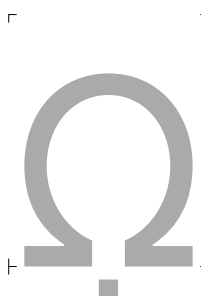

uni1FFC 1FFC

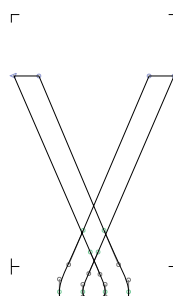

Gamma1 0194



afii10018 0411

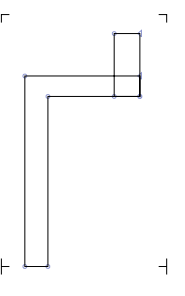

afii10050 0490



uni04FA 04FA

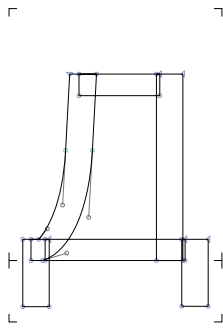

afii10021 0414

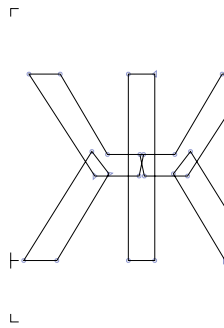

afii10024 0416

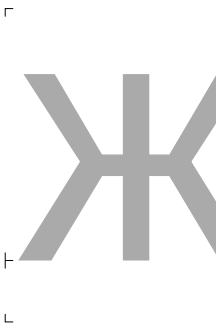

Zhedescendercyrillic 0496

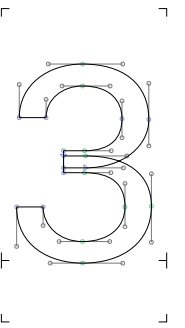

afii10025 0417

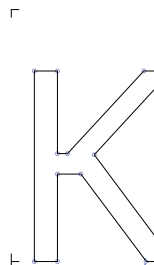

Kacyr 041A

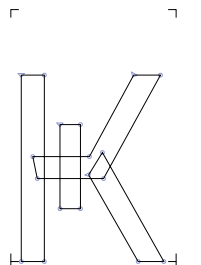

Kavertikalstrokcyrillic 049C

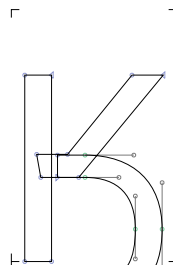

Kahookcyrillic 04C3

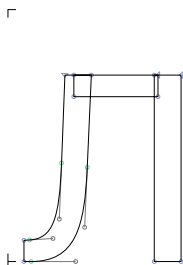

afii10029 041B

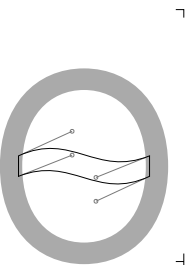

afii10147 0472

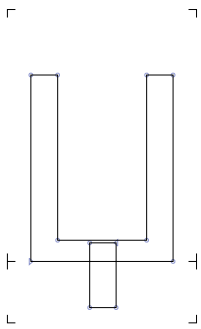

afii10145

040F

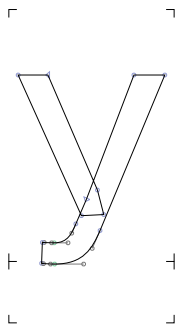

afii10037

0423

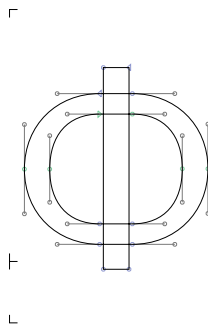

afii10038

0424

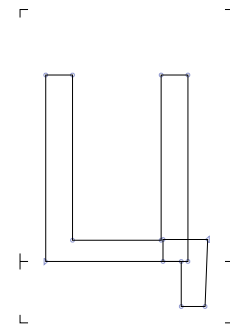

afii10040

0426

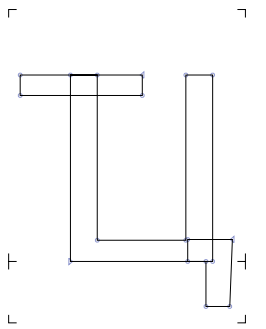

Tetsecyrillic

04B4

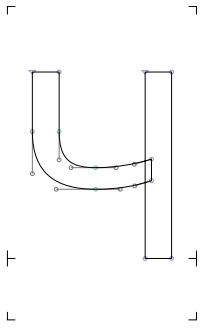

afii10041

0427



Chedescendercyrillic

04B6

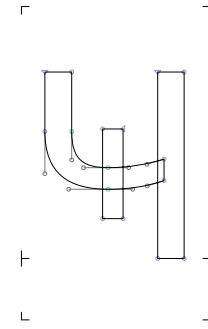

Cheverticalstrokecyrillic

04B8

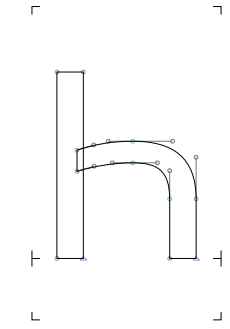

Shhacyrillic

04BA

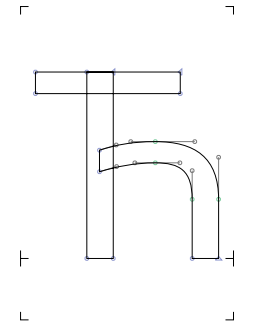

afii10060

040B

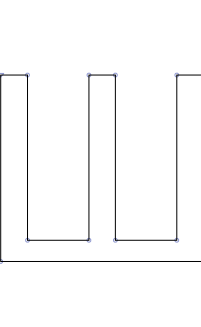

afii10042

0428

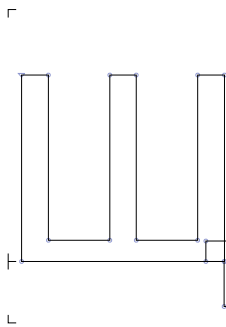

afii10043

0429

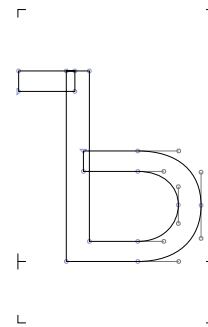

afii10044

042A



afii10045

042B

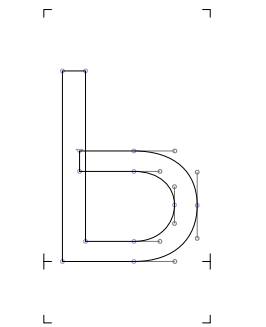

afii10046

042C

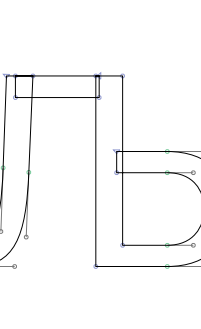

afii10058

0409

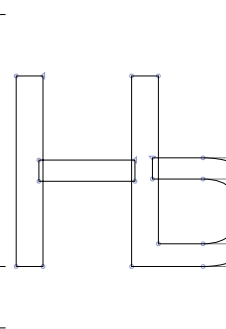

afii10059

040A

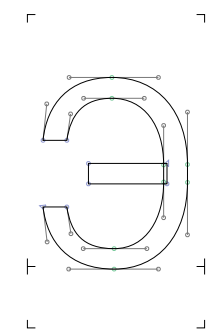

afii10047

042D



afii10048

042E

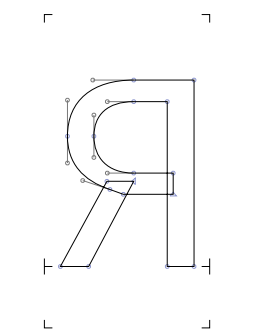

afii10049

042F



Ghemiddlehookcyrillic

0494



Pemiddlehookcyrillic

04A6

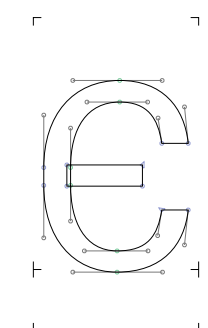

afii10053

0404

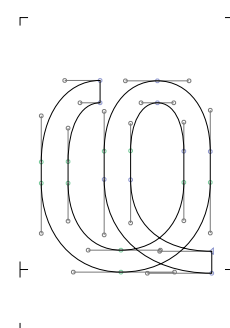

Haabkhasiancyrillic

04A8

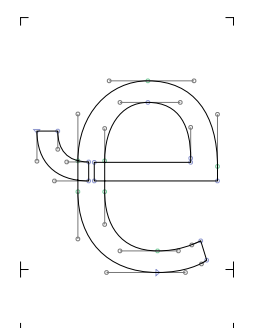

Cheabkhasiancyrillic

04BC

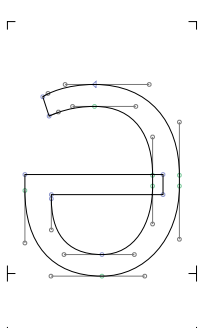

Schwacyrillic

04D8

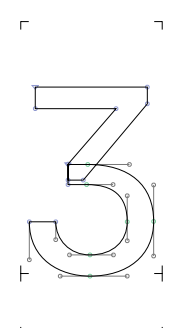

Dzeabkhasiancyrillic

04E0

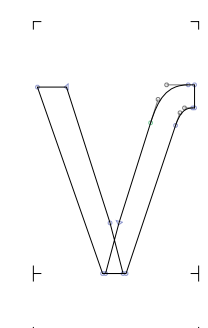

afii10148

0474

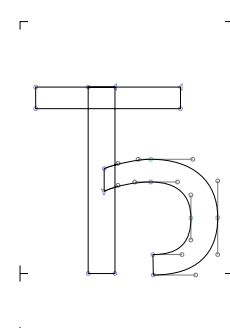

afii10051

0402

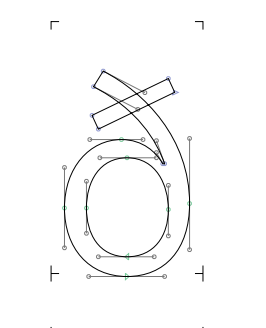

eth

00F0

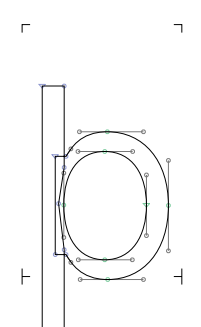

thorn

00FE

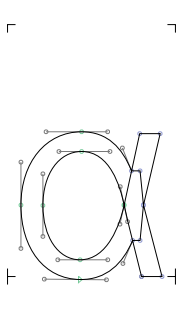

alpha

03B1



alphatonos

03AC

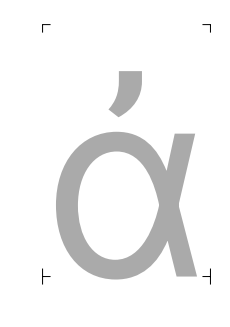

uni1F00

1F00

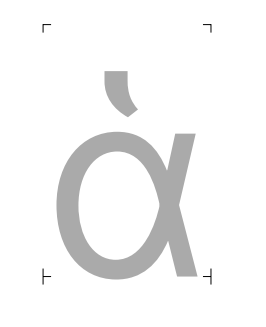

uni1F01

1F01



uni1F02

1F02



uni1F03

1F03



uni1F04

1F04



uni1F05

1F05



uni1F06

1F06



uni1F07

1F07

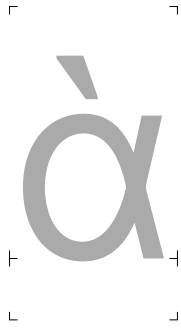

uni1F70

1F70



uni1F80

1F80



uni1F81

1F81



uni1F82

1F82



uni1F83

1F83



uni1F84

1F84



uni1F85

1F85



uni1F86

1F86



uni1F87

1F87



uni1FB0

1FB0



uni1FB1

1FB1



uni1FB2

1FB2



uni1FB3

1FB3



uni1FB4

1FB4



uni1FB6

1FB6



uni1FB7

1FB7

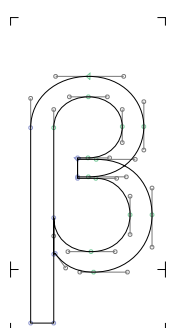

beta

03B2

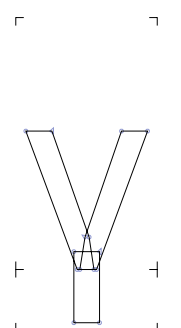

gamma

03B3

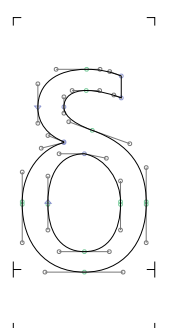

delta

03B4

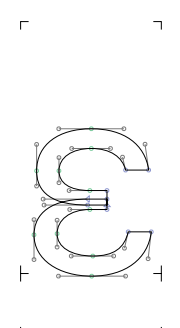

epsilon

03B5



epsilonontonos

03AD

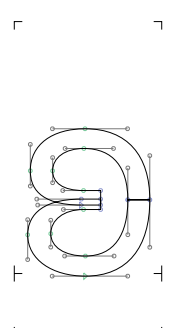

epsilonclosed

029A



epsilon1

025B



epsilon1rev

025C



epsilon1revclosed

025E

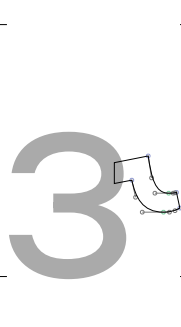

epsilon1revhook

025D



uni1F10

1F10



uni1F11

1F11



uni1F12

1F12



uni1F13

1F13



uni1F14

1F14



uni1F15

1F15



uni1F72

1F72

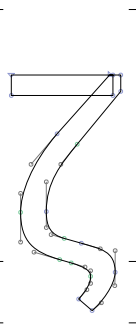

zeta

03B6

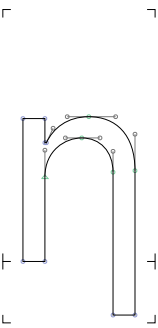

eta

03B7



etatonos

03AE



uni1F20

1F20



uni1F21

1F21



uni1F22

1F22



uni1F23

1F23



uni1F24

1F24



uni1F25

1F25



uni1F26

1F26



uni1F27

1F27



uni1F74

1F74



uni1F90

1F90



uni1F91

1F91



uni1F92

1F92



uni1F93

1F93



uni1F94

1F94



uni1F95

1F95



uni1F96

1F96



uni1F97

1F97



uni1FC2

1FC2



uni1FC3

1FC3



uni1FC4

1FC4



uni1FC6

1FC6



uni1FC7

1FC7

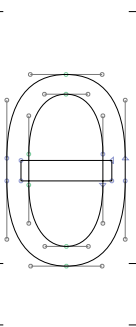

theta

03B8



iota

03B9

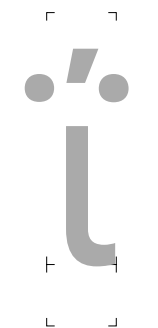

iotadiesistonos

0390



iotatonos

03AF

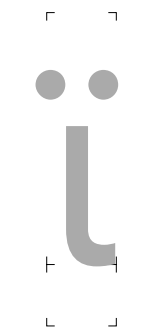





















iotadiesesis

03CA

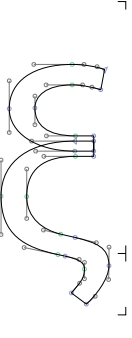
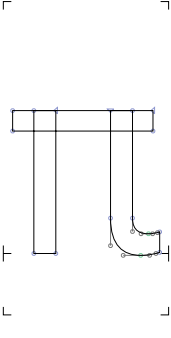
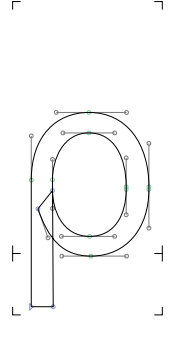
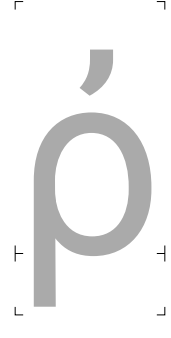
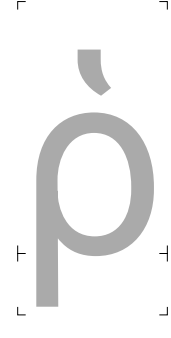
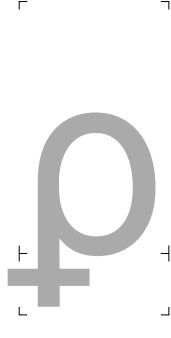
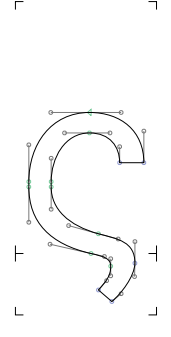
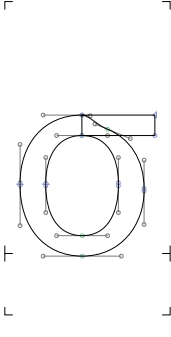
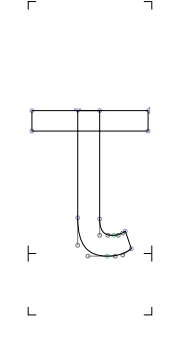
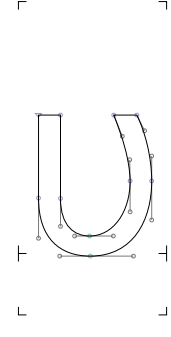
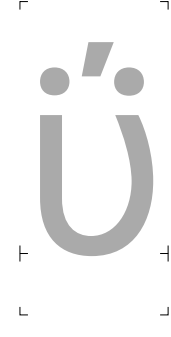

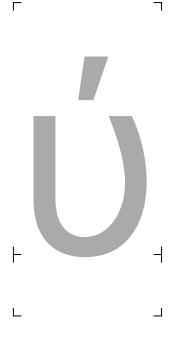
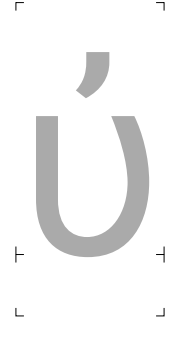
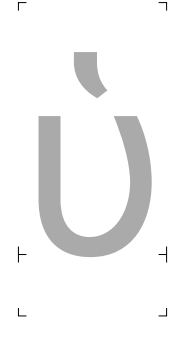
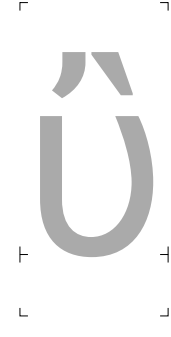
uni1F30

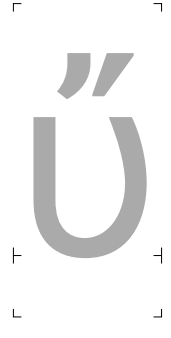
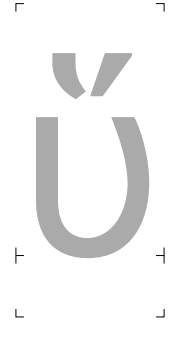
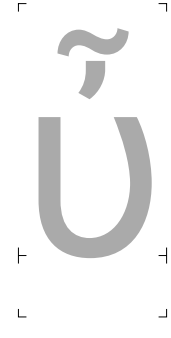
1F30

	uni1F31	1F31		uni1F32	1F32		uni1F33	1F33		uni1F34	1F34		uni1F35	1F35
	uni1F36	1F36		uni1F37	1F37		uni1F76	1F76		uni1FD0	1FD0		uni1FD1	1FD1
	uni1FD2	1FD2		uni1FD6	1FD6		uni1FD7	1FD7		lambda	03BB		xi	03BE
	pi	03C0		rho	03C1		uni1FE4	1FE4		uni1FE5	1FE5		uni03FC	03FC
	sigma1	03C2		sigma	03C3		tau	03C4		upsilon	03C5		upsilondieresistonos	03B0
	upsilondieresis	03CB		upsilontonos	03CD		uni1F50	1F50		uni1F51	1F51		uni1F52	1F52
	uni1F53	1F53		uni1F54	1F54		uni1F55	1F55		uni1F56	1F56		uni1F57	1F57

Ù Û Ū Ü Ů  
uni1F7A 1F7A uni1FE0 1FE0 uni1FE1 1FE1 uni1FE2 1FE2 uni1FE6 1FE6

Û ϕ ϕ ϕ ω  
uni1FE7 1FE7 phi 03C6 phigreek 03D5 psi 03C8 omega 03C9

ώ ώ ώ ώ ώ  
omegatonos 03CE uni1F60 1F60 uni1F61 1F61 uni1F62 1F62 uni1F63 1F63

ώ ώ ώ ώ ώ  
uni1F64 1F64 uni1F65 1F65 uni1F66 1F66 uni1F67 1F67 uni1F7C 1F7C

ώ ώ ώ ώ ώ  
uni1FA0 1FA0 uni1FA1 1FA1 uni1FA2 1FA2 uni1FA3 1FA3 uni1FA4 1FA4

ώ ώ ώ ώ ώ  
uni1FA5 1FA5 uni1FA6 1FA6 uni1FA7 1FA7 uni1FF2 1FF2 uni1FF3 1FF3

ώ ώ ώ γ ϐ  
uni1FF4 1FF4 uni1FF6 1FF6 uni1FF7 1FF7 gamma1 0263 becyrillic 0431



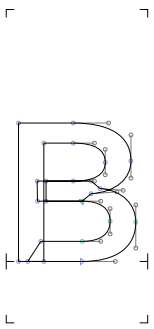

vecyrillic 0432

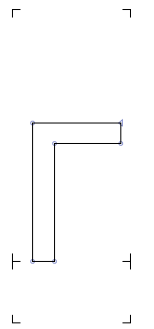

gecyrillic 0433

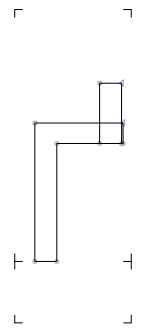

gheupturncyrillic 0491



uni04FB 04FB

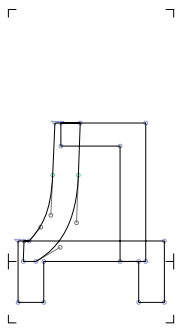

decyrillic 0434

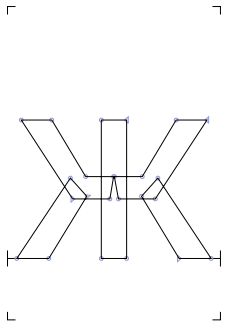

zhecyrillic 0436

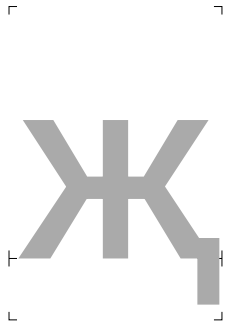

zhedescendercyrillic 0497

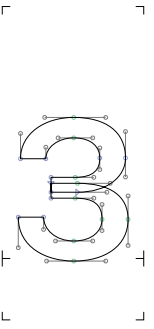

zecyrillic 0437

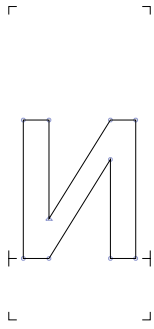

iicyrillic 0438



uni048B 048B

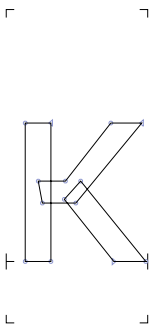

kacyrillic 043A

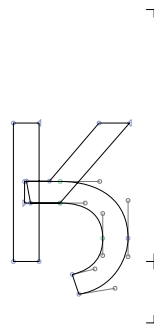

kahookcyrillic 04C4



kadescendercyrillic 049B

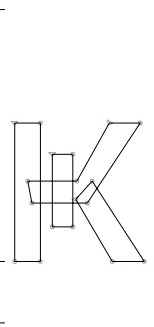

kavertikalstrokecyrillic 049D

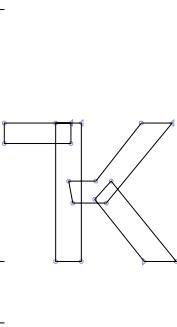

kabashkircyrillic 04A1

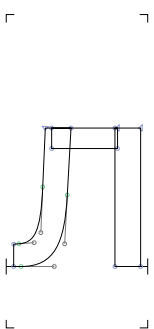

elcyrillic 043B



uni04C6 04C6

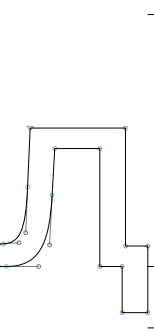

uni052F 052F

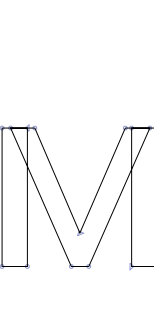

emcyrillic 043C



uni04CE 04CE

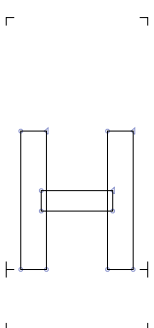

encyrillic 043D



endescendercyrillic 04A3

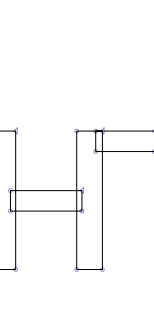

engcyrillic 04A5

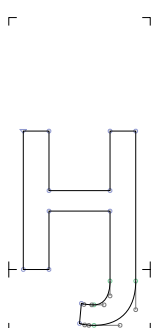

enhookcyrillic 04C8



uni04CA 04CA

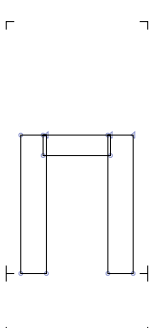

pecyrillic 043F

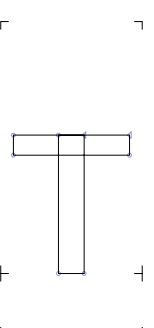

tecyrillic 0442

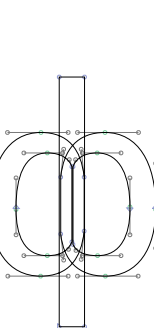

efcyrillic 0444

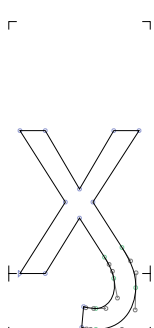

uni04FD 04FD



hadescendercyrillic 04B3

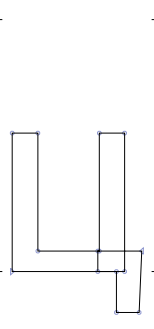

tsecyrillic 0446

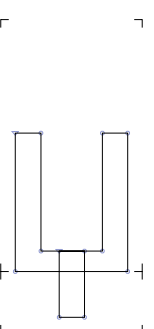

dzhecyrillic 045F

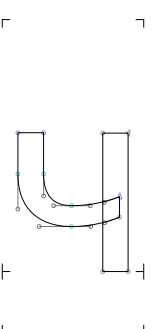

checyrillic 0447



chedescendercyrillic 04B7

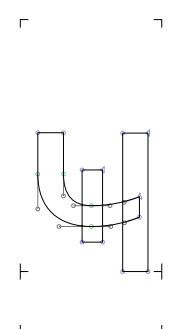

cheverticalstrokecyrillic 04B9

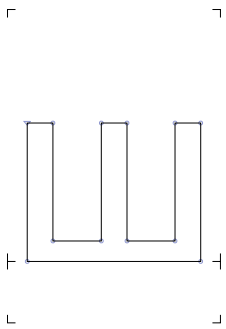

shacyrillic 0448

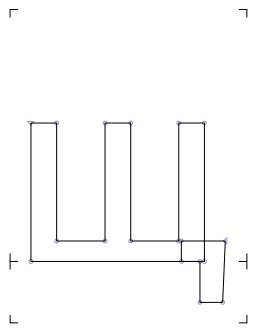

shchacyrillic 0449

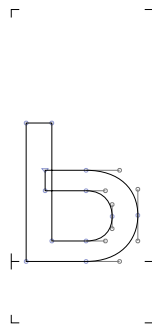

softsigncyrillic 044C

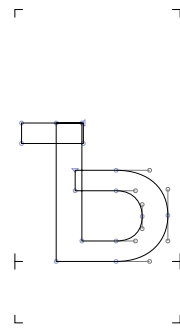

hardsigncyrillic 044A



yericyrillic 044B

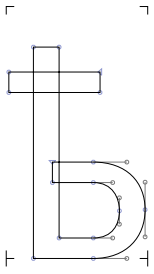

uni048D 048D

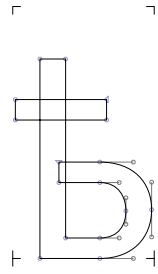

yatcyrillic 0463

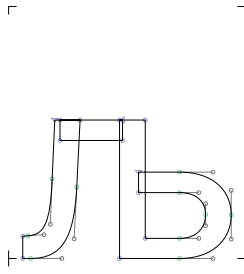

ljecyrillic 0459

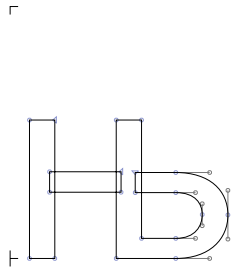

njecyrillic 045A

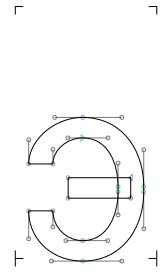

ereversedcyrillic 044D

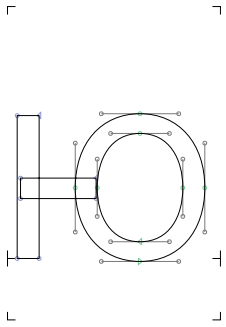

iucyrillic 044E

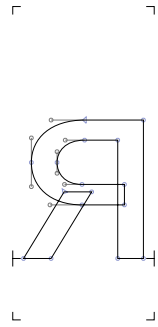

iacyrillic 044F

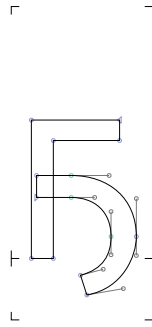

ghemiddlehookcyrillic 0495

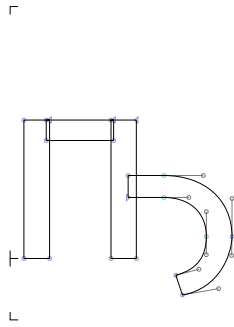

pemiddlehookcyrillic 04A7

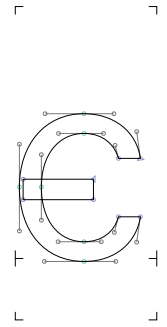

ecyrillic 0454

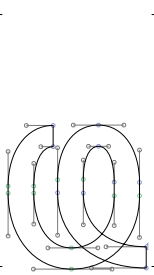

haabkhasiancyrillic 04A9

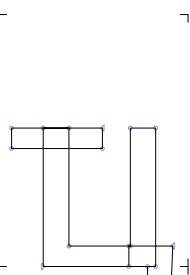

tetsecyrillic 04B5

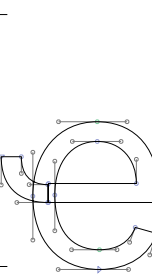

cheabkhasiancyrillic 04BD

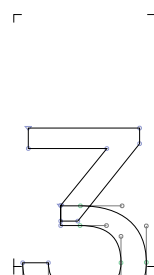

dzeabkhasiancyrillic 04E1

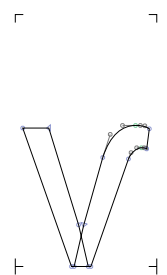

izhitsacyrillic 0475



dollar 0024

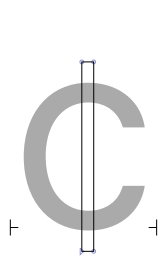

cent 00A2

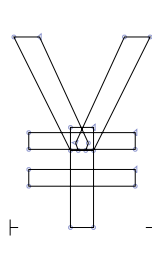

yen 00A5

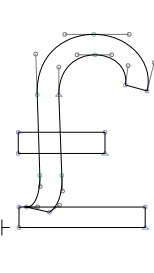

sterling 00A3

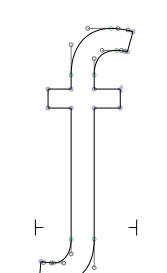

florin 0192

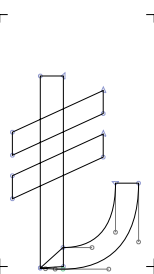

uni20BA 20BA

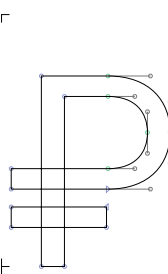

uni20BD 20BD

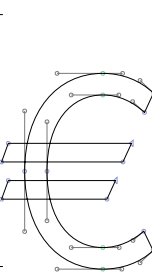

euro 20AC

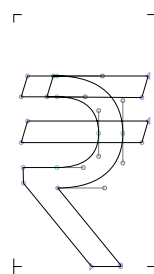

uni20B9 20B9

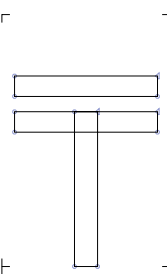

tenge 2088

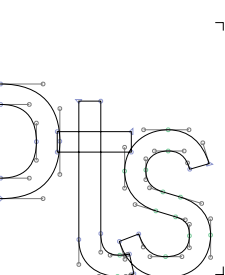

peseta 20A7

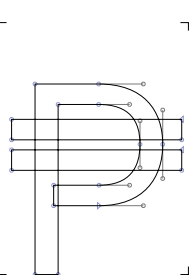

peso 20B1

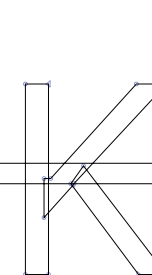

kip 20AD

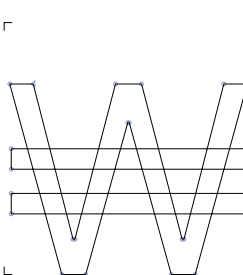

won 20A9

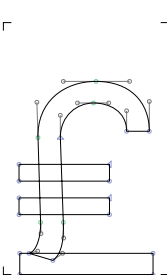

lira 20A4

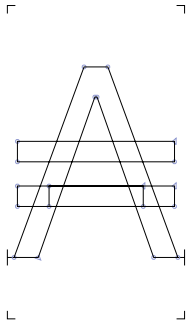

austral 20B3

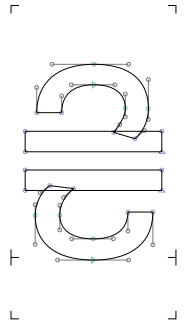

hryvnia 20B4

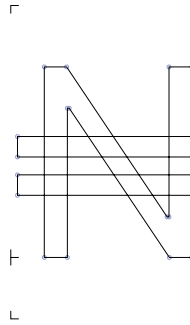

naira 20A6

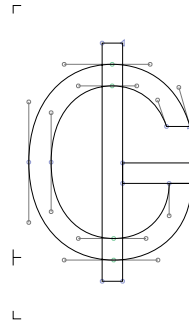

guarani 20B2

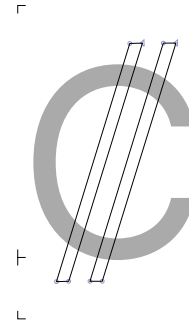

coloncurency 20A1

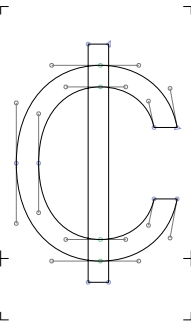

cedi 20B5

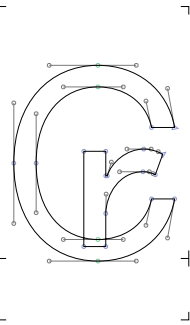

cruzeiro 20A2

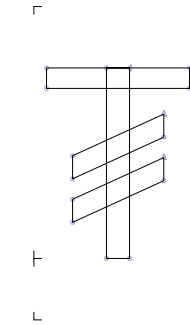

tugrik 20AE

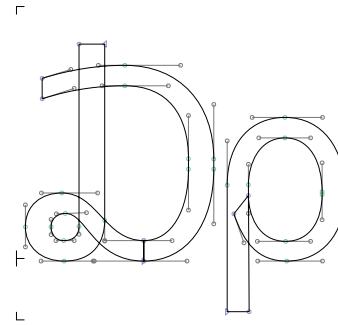

uni20AF 20AF

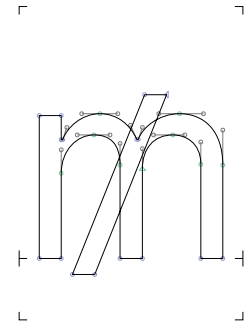

mill 20A5

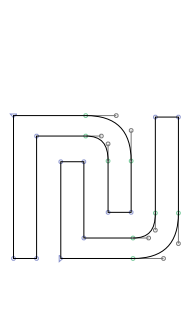

afi57636 20AA

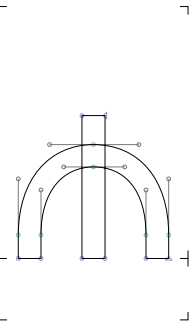

manat 20BC



rupee 20A8

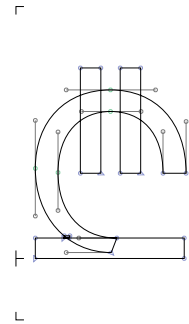

lari 20BE

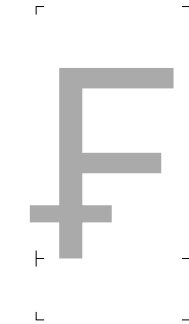

franc 20A3

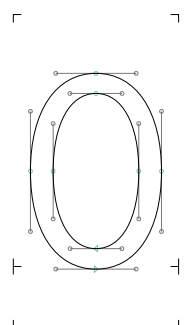

zero 0030

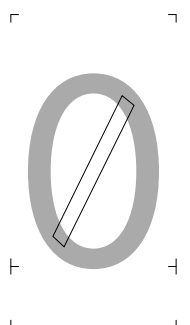

zero.slash

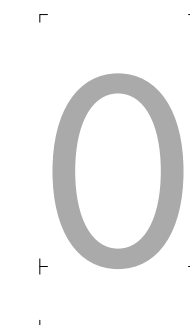

zero.tf



zero.tf.slash

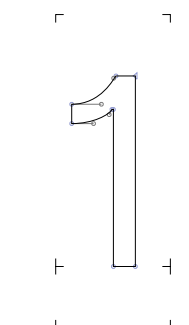

one 0031

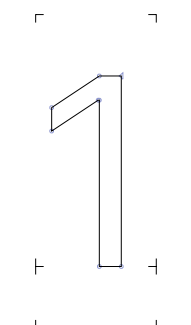

one.ss01

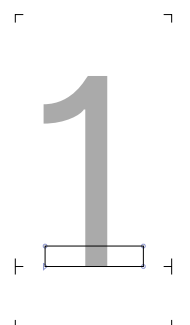

one.tf

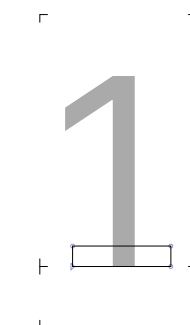

one.tf.ss01

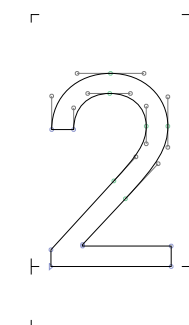

two 0032



two.tf



twostroke 01BB

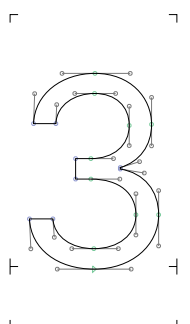

three 0033



three.tf

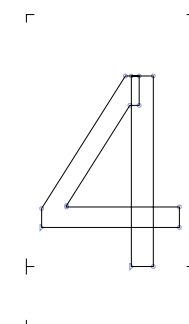

four 0034

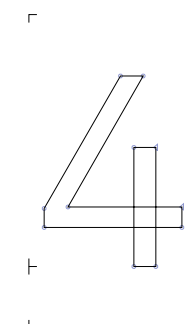

four.ss01



four.tf



four.tf.ss01

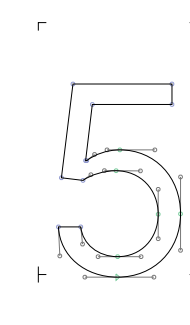

five 0035



five.tf

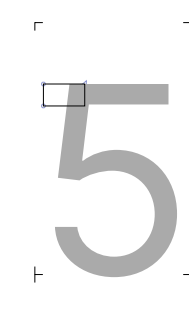

Tonefive 01BC

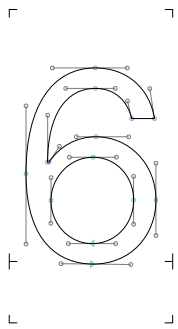

six 0036

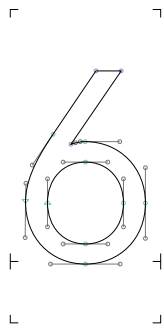

six.ss01



six.tf



six.tf.ss01

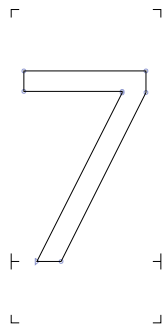

seven 0037



seven.tf

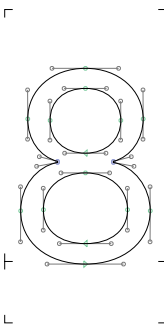

eight 0038



eight.tf

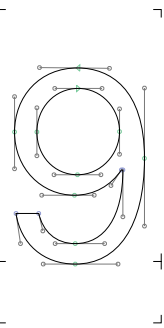

nine 0039

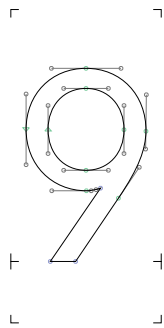

nine.ss01



nine.tf



nine.tf.ss01

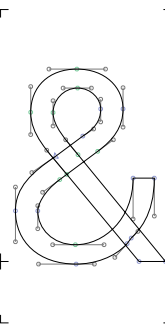

ampersand 0026

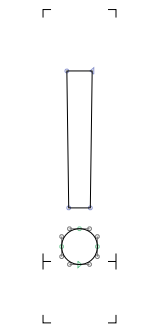

exclam 0021



exclamdown 00A1



uni2049 2049

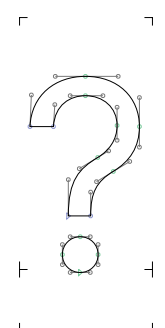

question 003F



uni2047 2047



uni2048 2048



questiondown 00BF

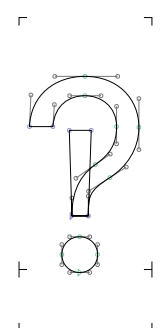

interrobang 203D



invertedinterrobang 2E18

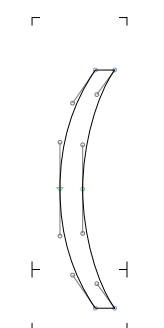

parenleft 0028



parenleft.case



parenright 0029



parenright.case

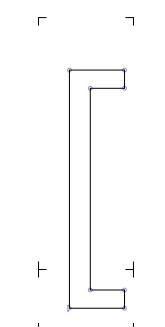

bracketleft 005B

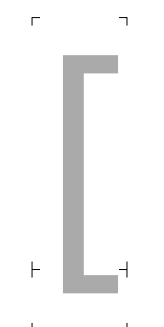

bracketleft.case

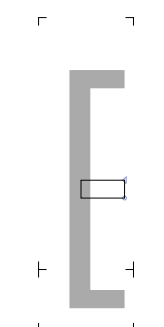

bracketleft\_quill 2045



bracketright 005D

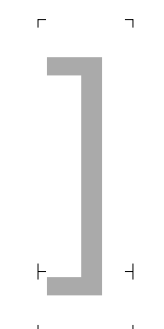

bracketright.case



bracketright\_quill 2046

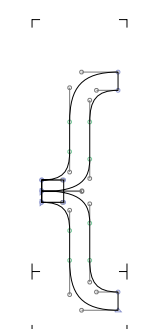

braceleft 007B

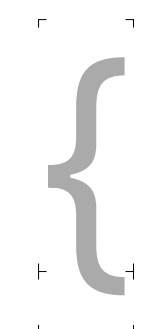

braceleft.case



braceright 007D



braceright.case

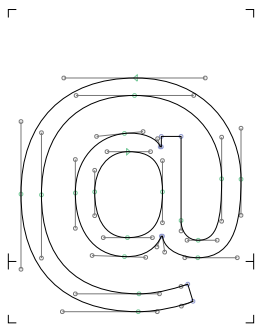

at 0040

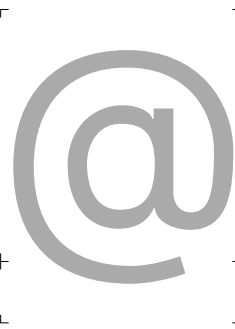

at.case

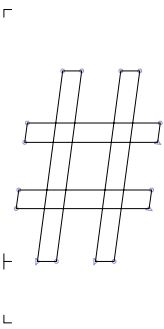

numbersign 0023

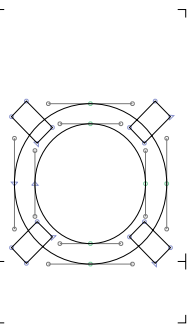

currency 00A4

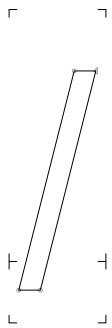

slash 002F

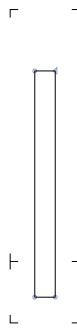

bar 007C

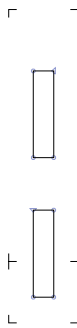

brokenbar 00A6

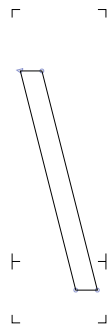

backslash 005C



hyphenbullet 2043

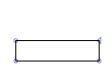

hyphen 002D



softhyphen 00AD



hyphen.case

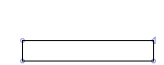

endash 2013



endash.case



figuredash 2012



figuredash.case



emdash 2014



emdash.case



horizontalbar 2015



bullet 2022



bullet.case



openbullet 25E6



openbullet.case



quoteleft 2018



quoteright 2019



apostrophemod 02BC



primetripl1 2034



quotesingle 0027



minute 2032



quotedbl 0022



second 2033



quotedblleft 201C



quotedblright 201D

quoteddblbase 201E	quotingsinglbase 201A	comma 002C	comma.tf	period 002E
period.tf	ellipsis 2026	twodotleader 2025	colon 003A	colon.case
colon.tf	semicolon 003B	semicolon.tf	guilsingleft 2039	guilsingright 203A
guillemetleft 00AB	guillemetright 00BB	less 003C	greater 003E	lessequal 2264
greaterequal 2265	equal 003D	equal.case	notequal 2260	notequal.case
plus 002B	plus.case	minus 2212	minus.case	multiply 00D7
multiply.case	divide 00F7	divide.case	plusminus 00B1	plusminus.case

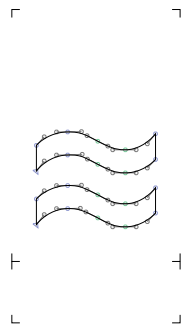

approxequal 2248

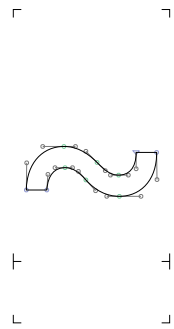

asciitilde 007E

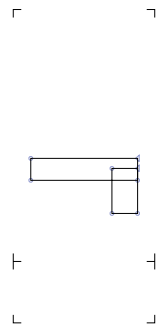

logicalnot 00AC



periodcentered 00B7



anoteleia 0387



questiongreek 037E



underscore 005F

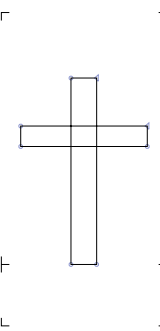

dagger 2020

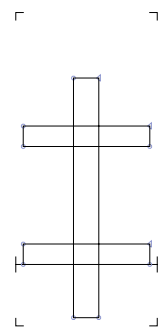

daggerdbl 2021

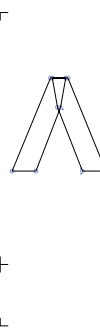

asciicircum 005E

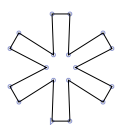

asterisk 002A



asterisk.case

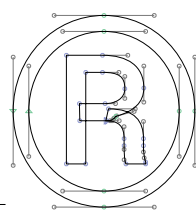

registered 00AE



trademark 2122

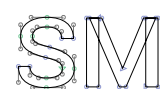

servicemark 2120

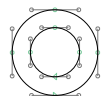

degree 00B0

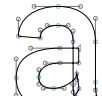

ordfeminine 00AA

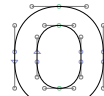

ordmasculine 00BA



i.numr

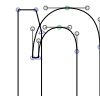

n.numr

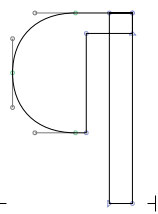

paragraph 00B6

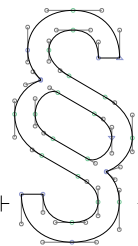

section 00A7

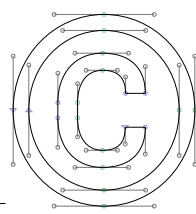

copyright 00A9

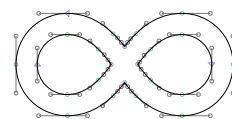

infinity 221E

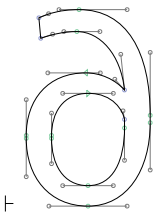

partialdiff 2202

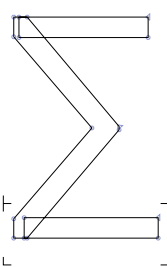

summation 2211

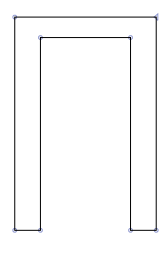

product 220F

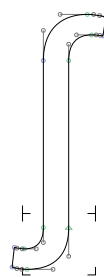

integral 222B

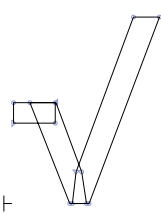

radical 221A

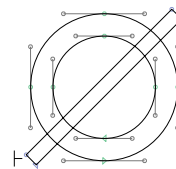

emptyset 2205

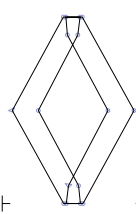

lozenge 25CA

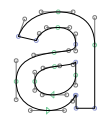

a.sups 1D43

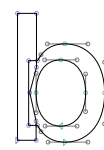

b.sups 1D47

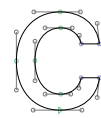

c.sups 1D9C

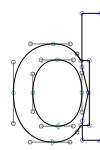

d.sups 1D48

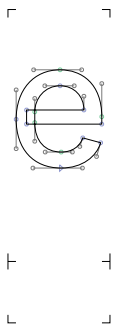

e.sups

1D49

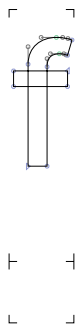

f.sups

1DA0

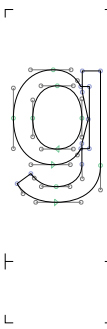

g.sups

1D4D

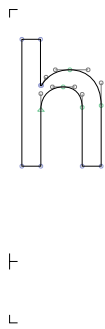

h.sups

02B0

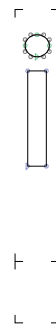

i.sups

2071



j.sups

02B2

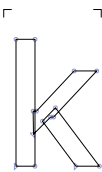

k.sups

1D4F

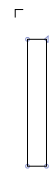

l.sups

02E1

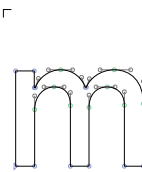

m.sups

1D50

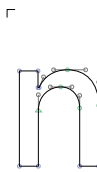

n.sups

207F

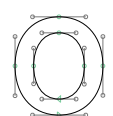

o.sups

1D52

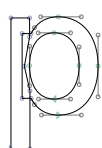

p.sups

1D56

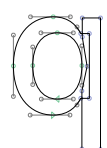

q.sups

146B

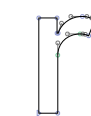

r.sups

02B3

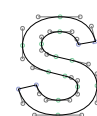

s.sups

02E2

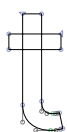

t.sups

1D57

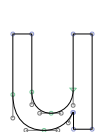

u.sups

1D58



v.sups

1D5B



w.sups

02B7



x.sups

02E3



y.sups

02B8

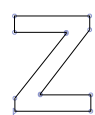

z.sups

1D8B

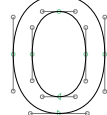

zero.sups

2070



one.sups

00B9



two.sups

00B2

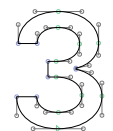

three.sups

00B3

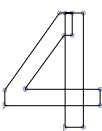

four.sups

2074

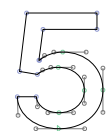

five.sups

2075

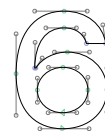

six.sups

2076

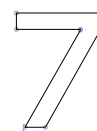

seven.sups

2077

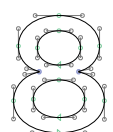

eight.sups

2078

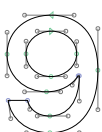

nine.sups

2079



parenleft.sups

207D



parenright.sups

207E

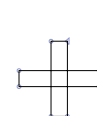

plus.sups

207A



—

=

a

b

c

minus.sups

207B

equal.sups

207C

a.sups

2090

b.sups

c.sups

d

e

f

g

h

d.sups

e.sups

2091

f.sups

g.sups

h.sups

2095

i

j

k

l

m

i.sups

1D62

j.sups

2C7C

k.sups

2096

l.sups

2097

m.sups

2098

n

o

p

q

r

n.sups

2099

o.sups

2092

p.sups

209A

q.sups

r.sups

1D63

s

t

u

v

w

s.sups

209B

t.sups

209C

u.sups

1D64

v.sups

1D65

w.sups

x

y

z

0

1

x.sups

2093

y.sups

z.sups

z.sups

2084

zero.sups

2080

one.sups

2081

2

3

4

5

6

two.sups

2082

three.sups

2083

four.sups

2084

five.sups

2085

six.sups

2086

7

seven.subs

2087

8

eight.subs

2088

9

nine.subs

2089

(

parenleft.subs

208D

)

parenright.subs

208E

+

plus.subs

208A

-

minus.subs

208B

=

equal.subs

208C

0

zero.dnomf

1

one.dnomf

2

two.dnomf

3

three.dnomf

4

four.dnomf

5

five.dnomf

6

six.dnomf

7

seven.dnomf

8

eight.dnomf

9

nine.dnomf

/

fraction 2044

0

zero.dnom

1

one.dnom

2

two.dnom

3

three.dnom

4

four.dnom

5

five.dnom

6

six.dnom

7

seven.dnom

8

eight.dnom

9

nine.dnom

+

plus.dnom

-

minus.dnom

=

equal.dnom

(

parenleft.dnom

)

parenright.dnom

0

zero.numr

1

2

3

4

5

one.numr

two.numr

three.numr

four.numr

five.numr

6

7

8

9

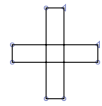

six.numr

seven.numr

eight.numr

nine.numr

plus.numr

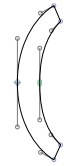

0

minus.numr

equal.numr

parenleft.numr

parenright.numr

zero.frac

1

2

3

4

5

one.frac

two.frac

three.frac

four.frac

five.frac

6

7

8

9

1/2

six.frac

seven.frac

eight.frac

nine.frac

onehalf

00BD

1/4

3/4

5/6

1/

7/8

onequarter

00BC

threequarters

00BE

fivesixths

215A

onefraction

215F

seveneighths

215E

1/8

5/8

3/8

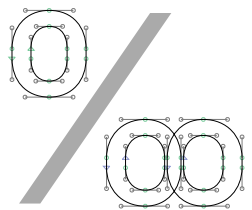
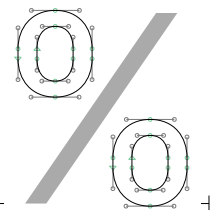

oneeighth

215B

fiveeighths

215D

threeeighths

215C





percent





0025





perthousand





2030





<b>pertenthousand</b> 2031	uni214D 214D	cadauna 2106	careof 2105	accountof 2100
addresssubject 2101	numero 2116	acute 00B4	hungarumlaut 02DD	grave 0060
tonos 0384	dieresis 00A8	<b>casedieresis.cn</b>	circumflex 02C6	tilde 02DC
<b>casetilde.cn</b>	macron 00AF	breve 02D8	cyrillicbreve	dotaccent 02D9
ring 02DA	caron 02C7	dieresis-tonos 0385	cedilla 00B8	ogonek 02DB
commaaccent F6C3	acutecomb 0301	acutedblnosp 030B	gravecomb 0300	dblgravecmb 030F
macroncomb 0304	dieresisnosp 0308	brevenosp 0306	breveinvnosp 0311	hook 0309



				
+	+	+	+	+
+	+	+	+	+
circumflexnosp 0302	caroncmb 030C	tildecomb 0303	dotnosp 0307	ringnosp 030A



				
+	+	+	+	+
+	+	+	+	+
hornnosp 031B	ogoneknosp 0328	cedillanosp 0327	circumflexsubnosp 032D	brevesubnosp 032E

				
+	+	+	+	+
+	+	+	+	+
dotbelow 0323	commabelowcmb 0326	dotdblsubnosp 0324	ringsubnosp 0325	underscorenosp 0332

				
+	+	+	+	+
+	+	+	+	+
tildesubnosp 0330	enquad 2000	emquad 2001	enspace 2002	emspace 2003

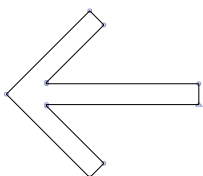
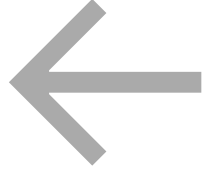
				
+	+	+	+	+
+	+	+	+	+
thirdemspace 2004	quarteremspace 2005	sixthemspace 2006	figurespace 2007	punctuationspace 2008

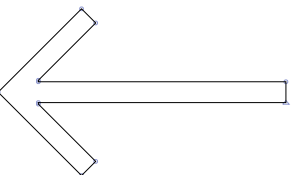
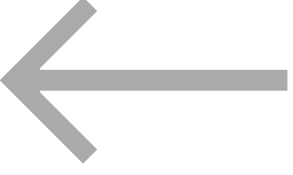
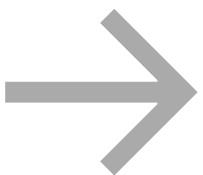
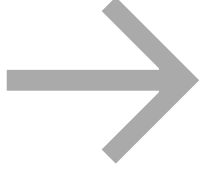
				
+	+	+	+	+
+	+	+	+	+
thinspace 2009	hairspace 200A	zerowidthspace 200B	leftArrow 2190	leftArrow.case

				
+	+	+	+	+
+	+	+	+	+
leftLongArrow 27F5	leftLongArrow.case	rightArrow 2192	rightArrow.case	rightLongArrow 27F6

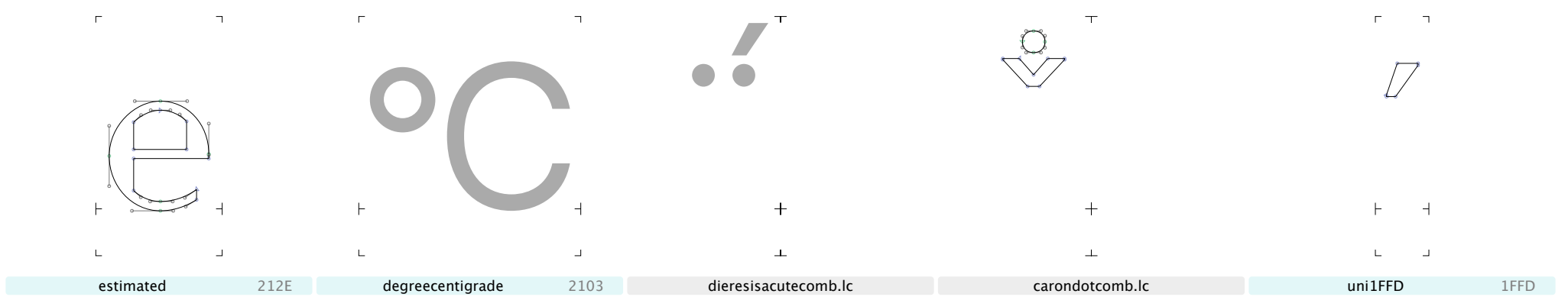
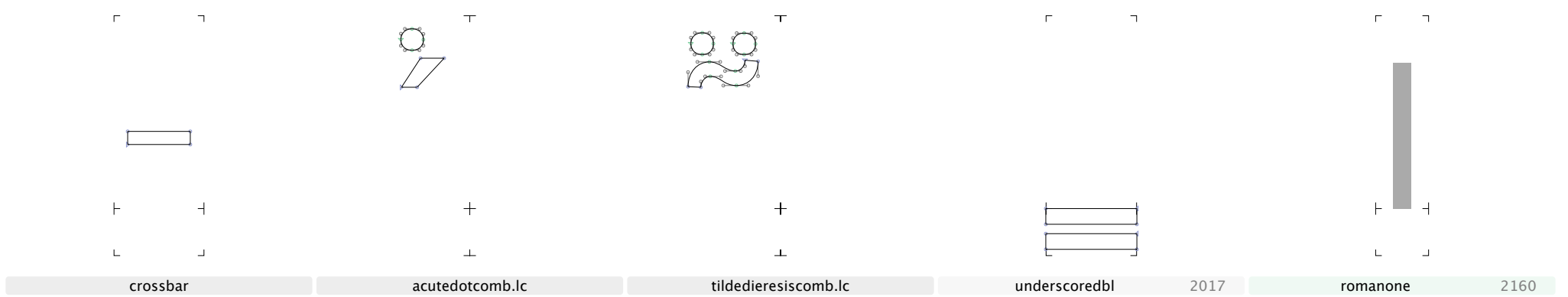
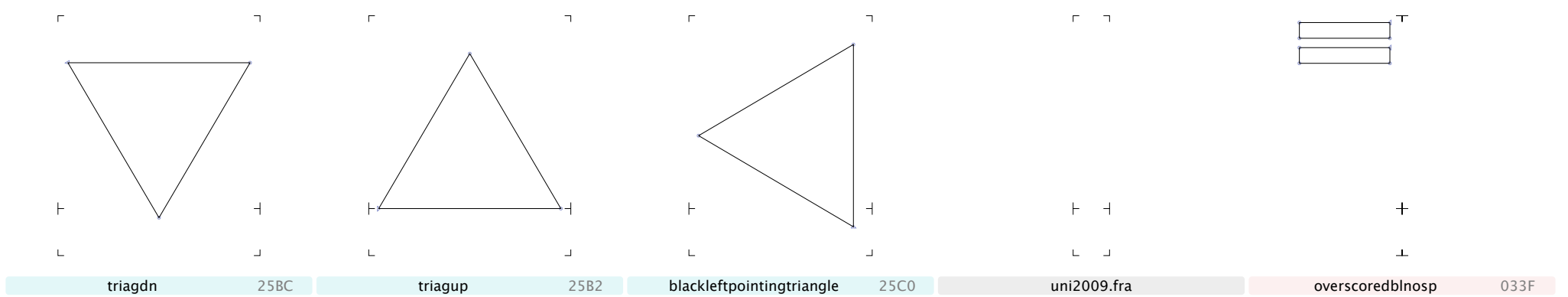
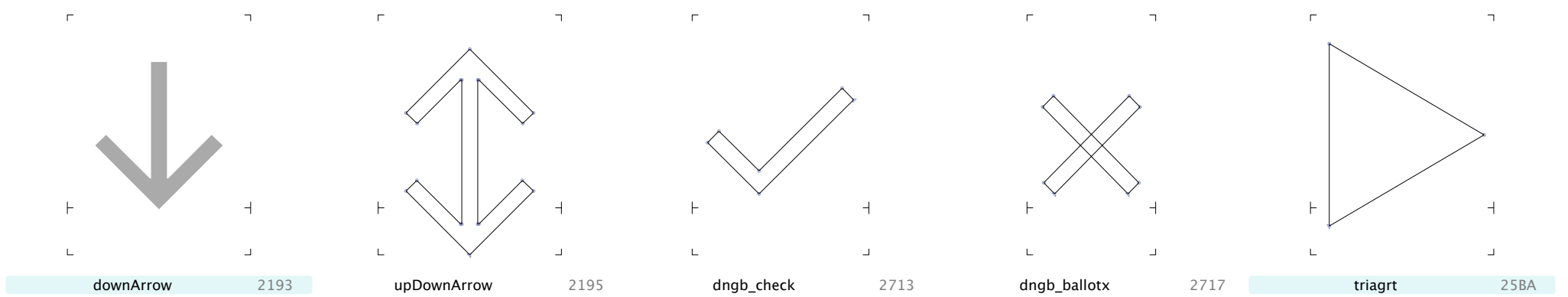
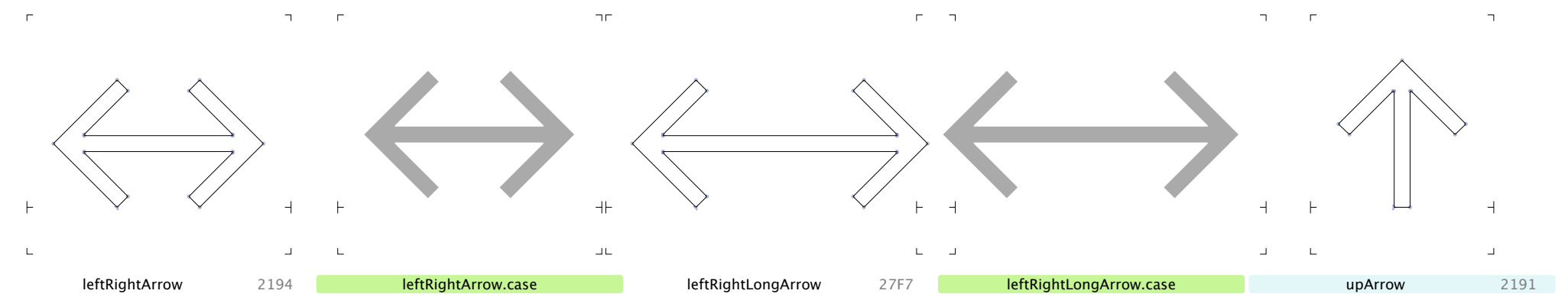
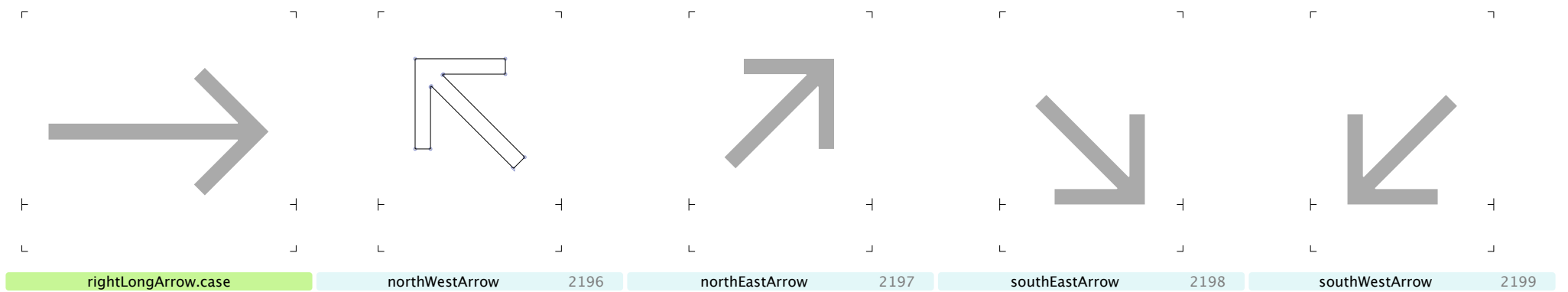

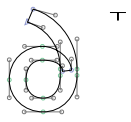

T

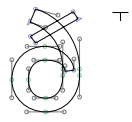

T

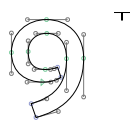

T

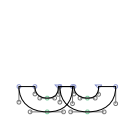

T

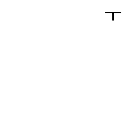

T

+

+

+

+

+

+

+

+

+

+

uni1DD8

1DD8

uni1DD9

1DD9

uni1DD2

1DD2

uni1DD3

1DD3

uni1DD0

1DD0



T

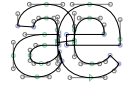

T

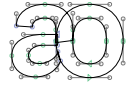

T



T

+

+

+

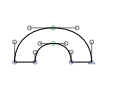

+

+

+

+

+

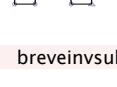

+

+

uni1DD1

1DD1

uni1DD4

1DD4

uni1DD5

1DD5

breveinvsubnosp

032F

commaturnsupnosp

0312



T

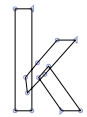

T

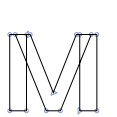

T

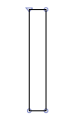

T

+

+



+

+

+

+

+

+

+

+

uni1DD8

1DD8

uni1DDC

1DDC

ringrighthalfsubnosp

0339

uni1DDF

1DDF

uni1DDD

1DDD



T

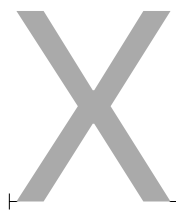

T



T



T

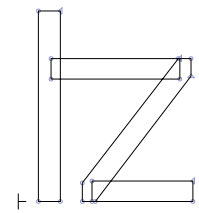

T

+

+

+

+

+

+

+

+

+

+

uni1DDE

1DDE

romanten

2169

degreefahrenheit

2109

degreekelvin

212A

uni02AB

02AB

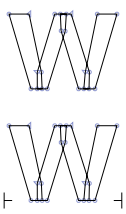

uni02AC

02AC

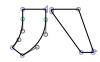

uni1FCD

1FCD

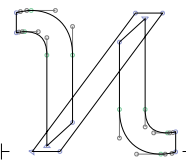

kappa1

03F0

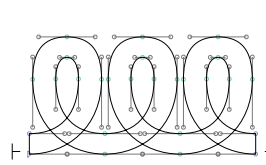

uni214F

214F

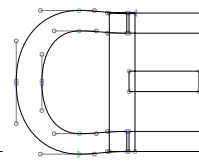

OEmallcap

0276

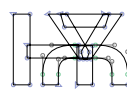

uni2DFF

2DFF

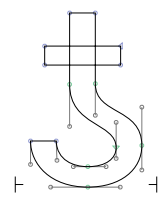

glottalstopbarinv

01BE

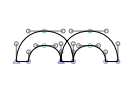

seagullsubnosp

033C

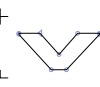

uni02EC

02EC



tackupsubnosp

031D

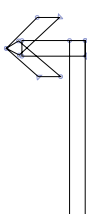

afi300

200F



caronnosp



romanfour

2163

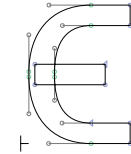

uni03F5

03F5

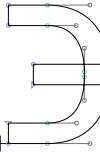

uni03F6

03F6

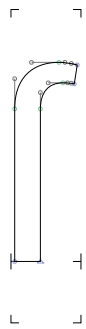

longs

017F

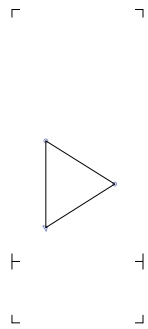

trianglebullet

2023

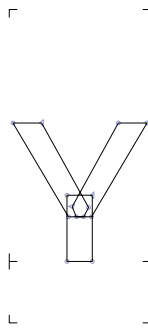

Ysmallcap

028F

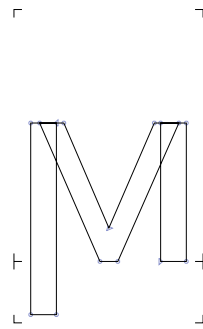

uni03FB

03FB

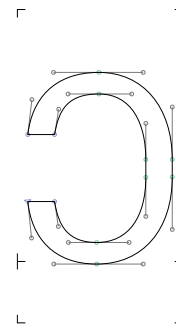

uni03FD

03FD



uni03FE

03FE



uni03FF

03FF

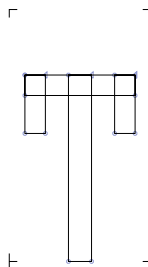

uni0373

0373

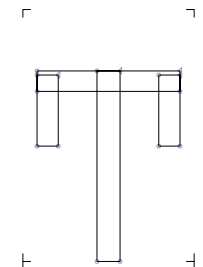

uni0372

0372

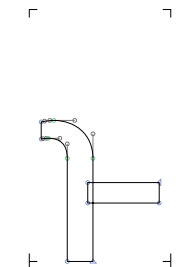

uni0371

0371

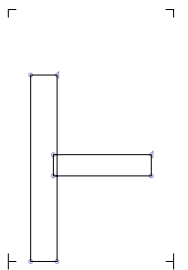

uni0370

0370

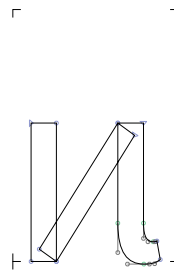

uni0377

0377

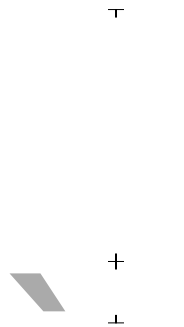

gravesubnosp

0316

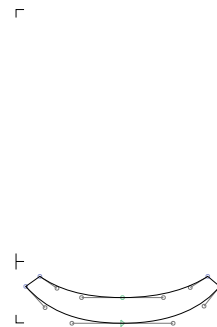

undertie

203F

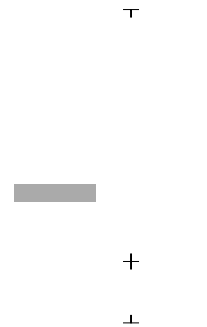

barmidshortnosp

0335

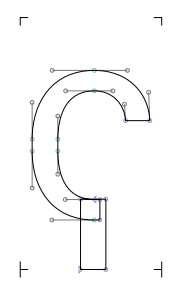

glottalstoprevinv

0295

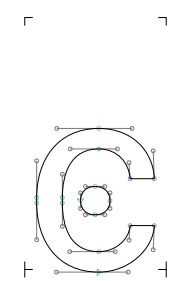

uni037C

037C

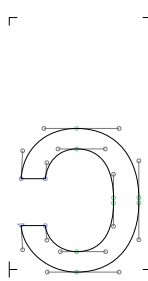

uni037B

037B

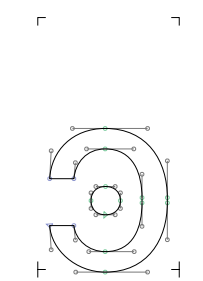

uni037D

037D

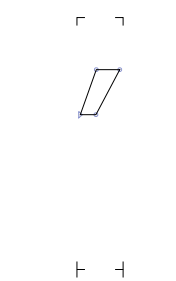

primemod

0289

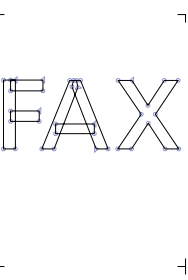

uni213B

213B

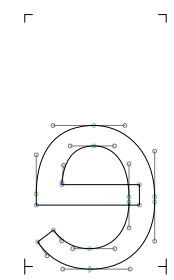

erev

0258

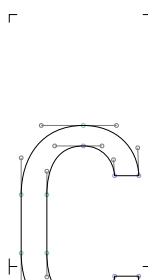

cstretch

0297



Btopbar

0182

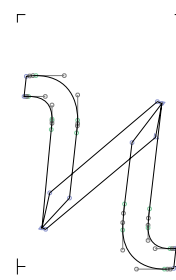

Koppa

03DE

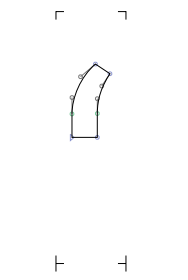

commaturnedmod

02BB

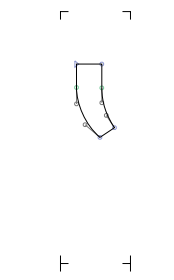

commareversedmod

02BD

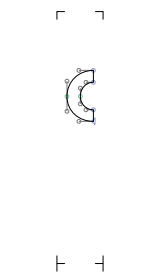

ringhalleft

02BF

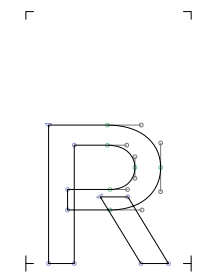

Rsmallcap

0280

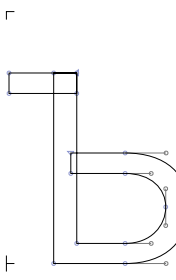

Tonesix

0184

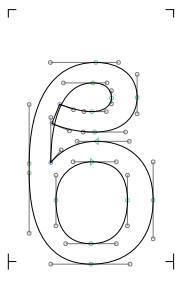

beta1

03D0



uni204F

204F



uni204E

204E

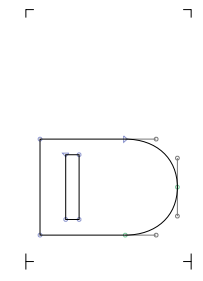

uni204D

204D

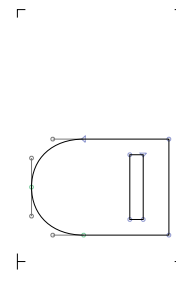











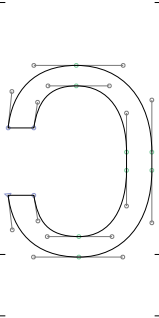
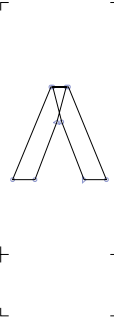
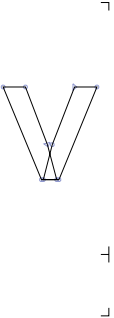
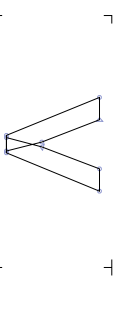
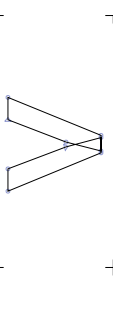
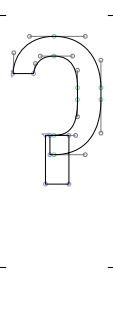

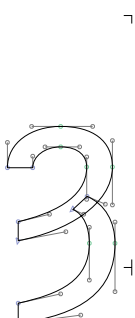
uni204C

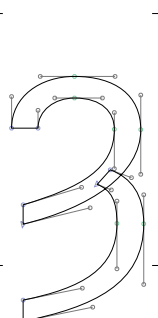
204C

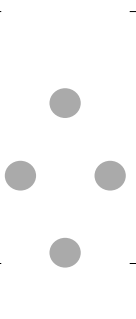
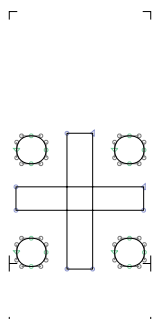
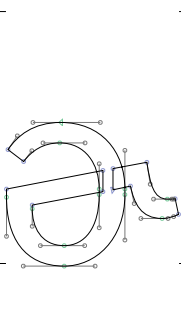
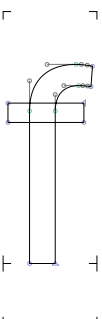

uni204B 204B	uni204A 204A	CR	slashlongnosp 0338	exclam1 01C3
Digamma 03DC	candrabindunosp 0310	qofdagesh 02DF	uni36A 036A	uni36B 036B
uni36C 036C	uni36D 036D	uni36E 036E	uni36F 036F	uni20B7 20B7
uni20B6 20B6	uni20B0 20B0	uni20BB 20BB	tildedoublecmb 0360	breveinverteddoublecmb 0361
uni362 0362	uni363 0363	uni364 0364	uni365 0365	uni366 0366
uni367 0367	uni368 0368	uni369 0369	tildemidnosp 0334	uni01F7 01F7
glottalstopinv 0296	acutelowmod 02CF	gravelowmod 02CE	fourthtonechinese 02CB	verticallinelowmod 02CC

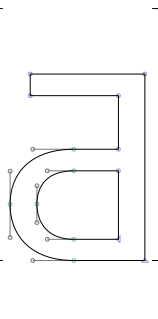
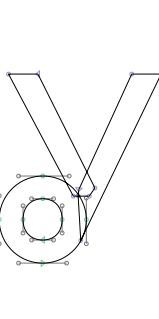
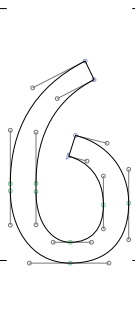
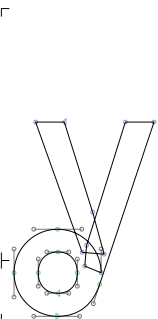
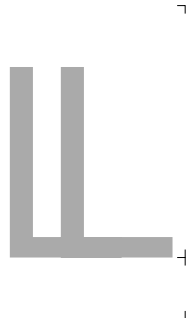
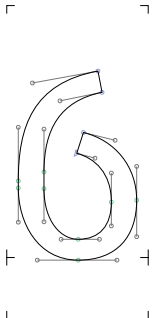
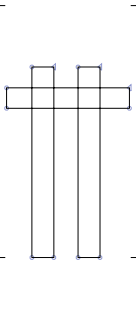
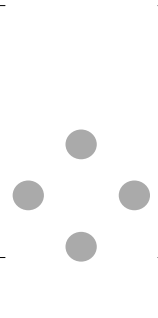
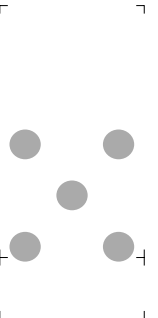
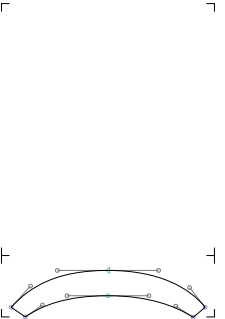
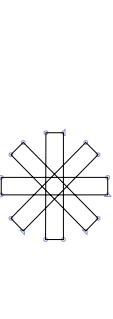
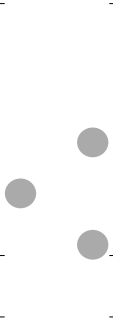
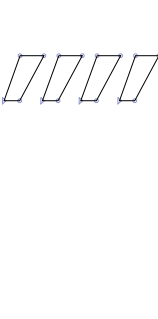
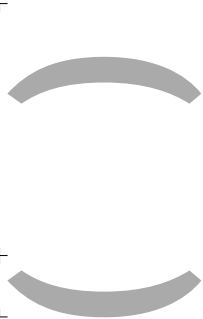
				
secondtonechinese 02CA	romantwelve 216B	uni2183 2183	arrowheadupmod 02C4	arrowheaddownmod 02C5
				
arrowheadleftmod 02C2	arrowheadrightmod 02C3	glottalstopmod 02C0	firsttonechinese 02C9	uni021D 021D
				
uni0268.ccmp	uni021C 021C	numeralgreeksub 0375	caronsubnosp	uni205E 205E
				
uni205A 205A	uni205B 205B	uni205C 205C	schwahook 025A	uni1E9D 1E9D
				
uni1E9F 1E9F	Dtopbar 018B	uni1EFE 1EFE	uni1EFD 1EFD	uni1EFF 1EFF
				
uni1EFA 1EFA	uni1EFC 1EFC	uni1EFB 1EFB	uni2058 2058	uni2059 2059
				
uni2054 2054	uni2055 2055	uni2056 2056	uni2057 2057	uni2050 2050

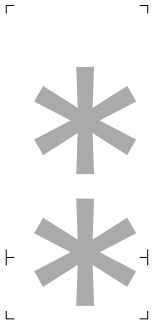

uni2051

2051

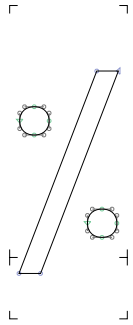

uni2052

2052

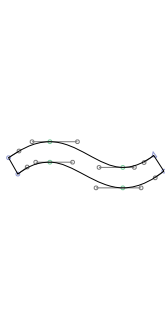

uni2053

2053



ascript\_uni02DE

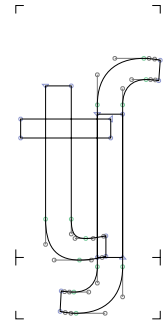

tesh

02A7

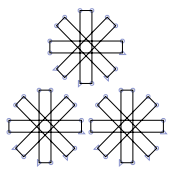

asterism

2042

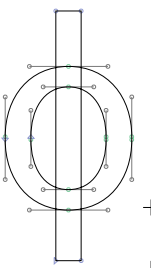

philatin

0278



sixroman

2175



cyrillichookleft

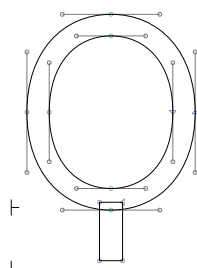

uni03D8

03D8

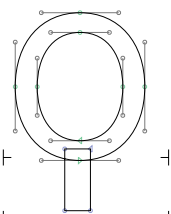

uni03D9

03D9

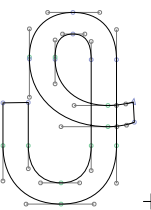

thetasymbolgreek

03D1

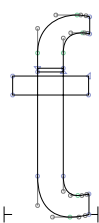

thook

01AD

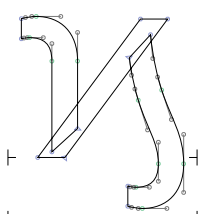

uni03D7

03D7



uni27EF

27EF

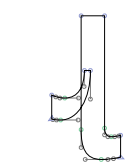

finaltsadi

02B5

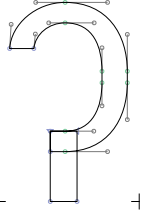

glottalstop

0294



uni0359

0359



uni0358

0358



uni0355

0355



uni0354

0354



uni0357

0357



uni0356

0356



uni0351

0351

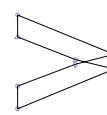

uni0350

0350

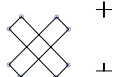

uni0353

0353



uni0352

0352

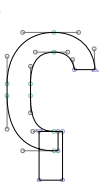

glottalstopreversedmod

02C1



uni035E

035E

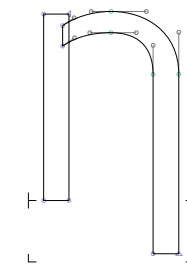

uni0220

0220

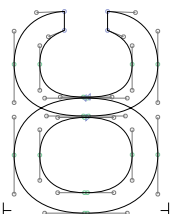

uni0223

0223

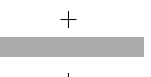

uni035F

035F

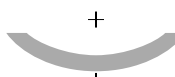

uni035C

035C



uni035B

035B

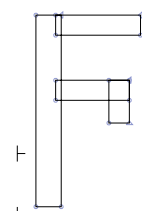

digamma

03DD

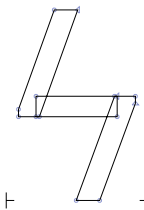

koppa

03DF



ringhalfrightcentered

02D2



colontriangularhalfmod

02D1



colontriangularmod

02D0



minusmod

02D7



plusmod

02D6



downtackmod

02D5



linevertnossp

030D

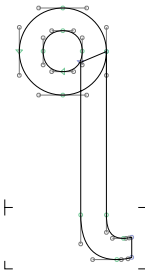

eshloopprev

01AA



verticalbardbl

2016



romaneleven

216A

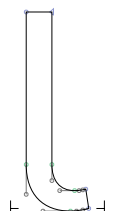

iota1

0196

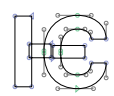

uniA69F

A69F

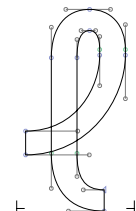

Isquare

2113



rhotichookmod

02DE



uni1DD6

1DD6

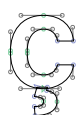

uni1DD7

1DD7



linevertsubnossp

0329

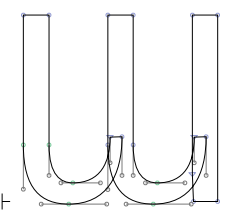

mcapturen

019C



uni205D

205D

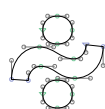

uni034B

034B

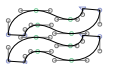

uni034C

034C

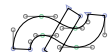

uni034A

034A



uni034F

034F

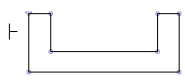

spaceopenbox

2423

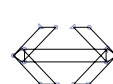

uni034D

034D



uni034E

034E



uni0348

0348



uni0349

0349



reverseddblprime

2036



perispomenigreekcmb

0342



koroniscmb

0343



uni0347

0347

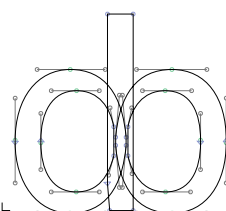

uni0238



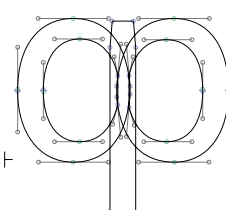

0238



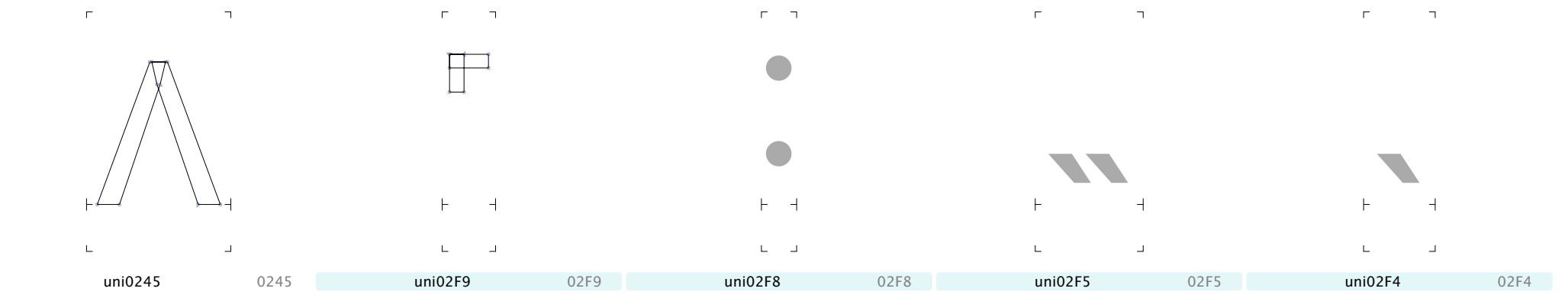
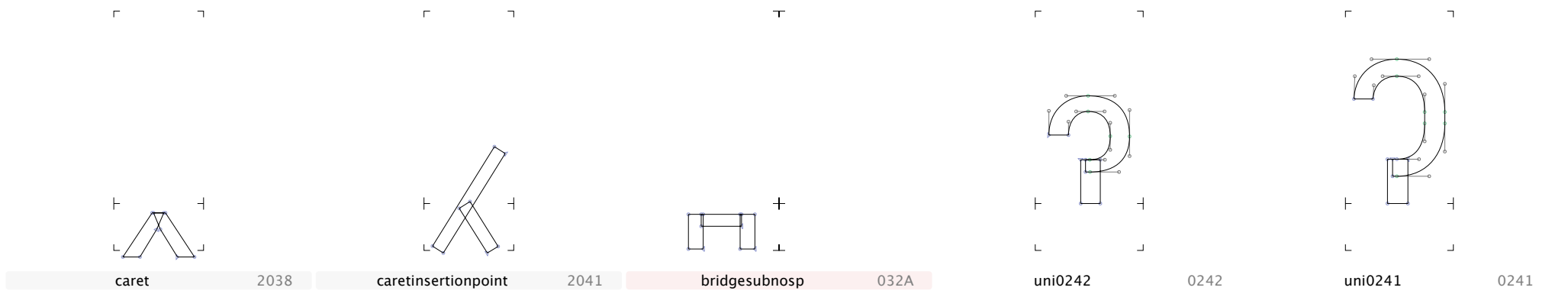
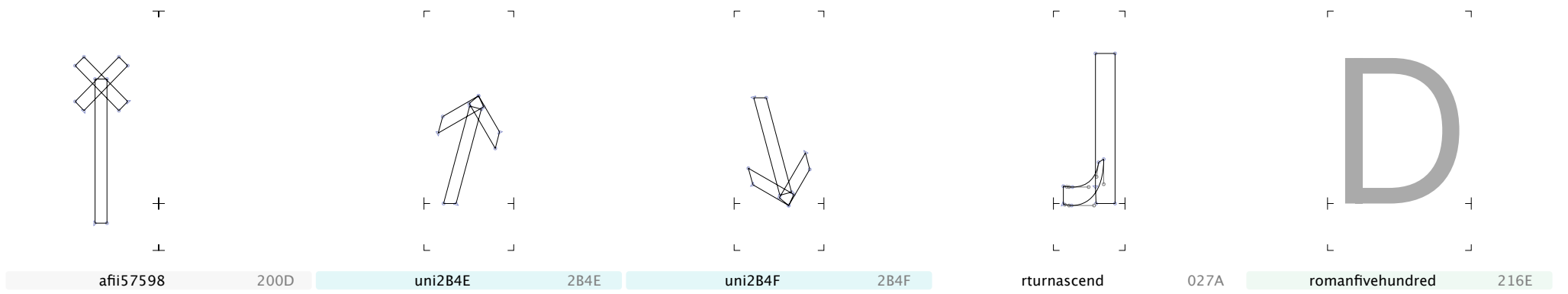
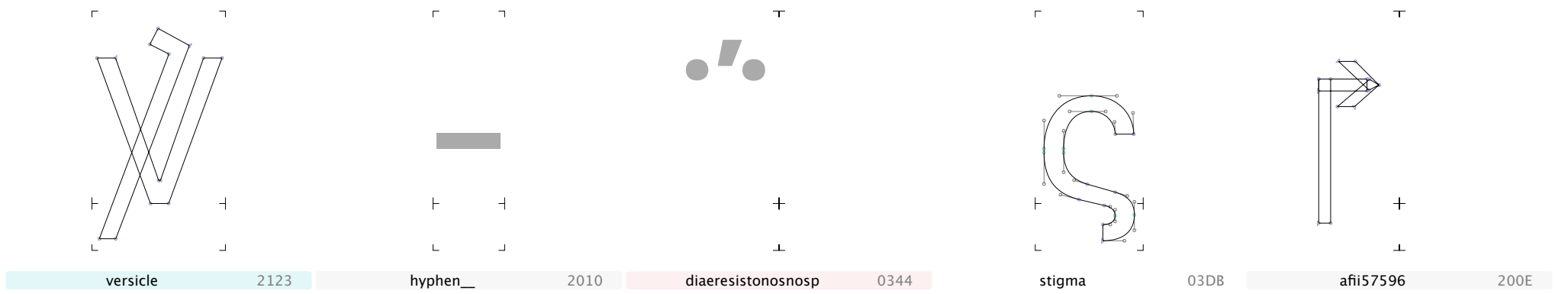
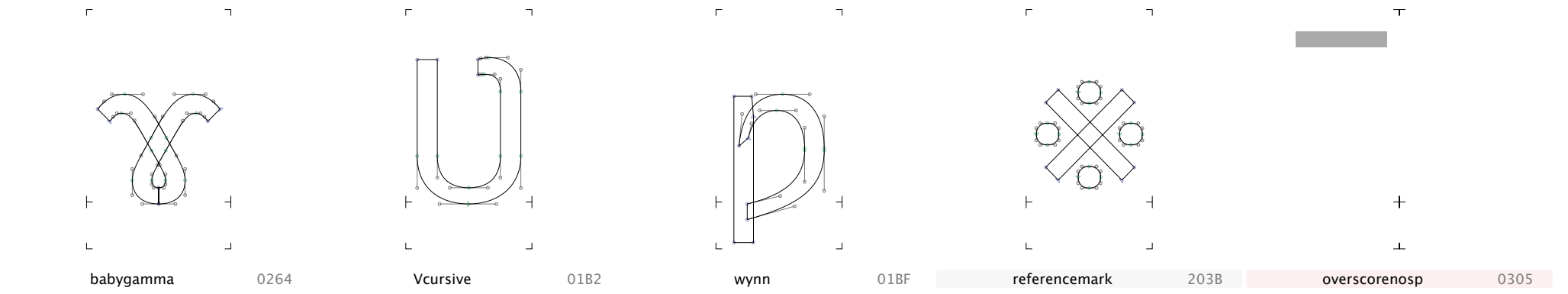
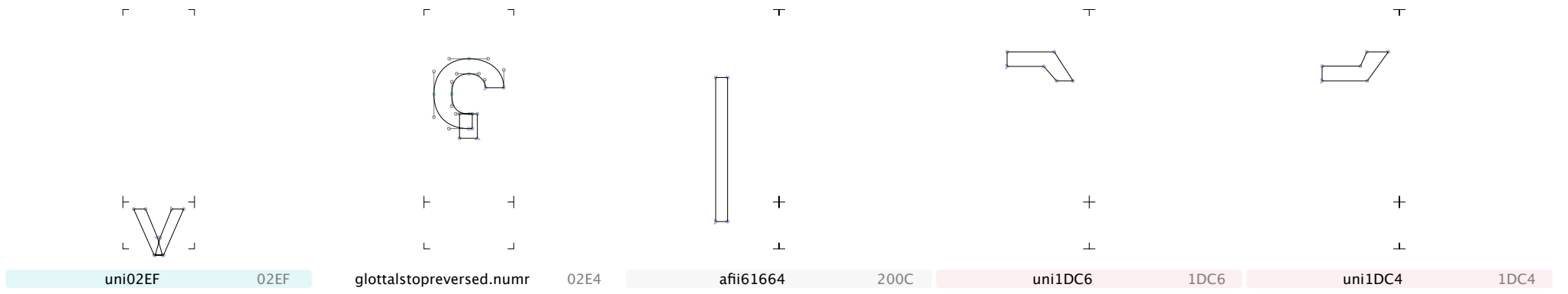
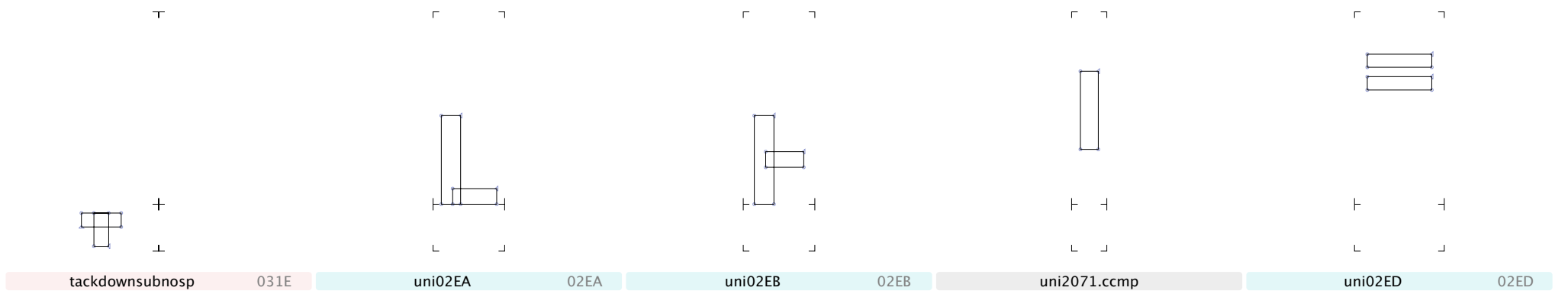

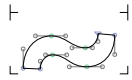

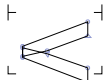

uni0239

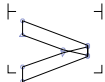

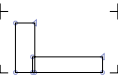
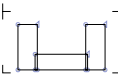
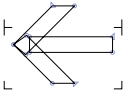

0239



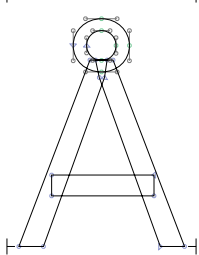
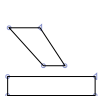

				
uni02F7 02F7	uni02F6 02F6	uni02F1 02F1	uni02F0 02F0	uni02F3 02F3

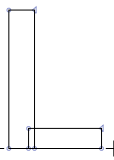

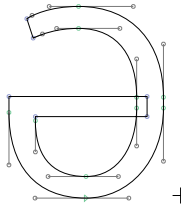
				
uni02F2 02F2	dotmacroncomb.lc	uni02FE 02FE	uni02FD 02FD	uni02FF 02FF

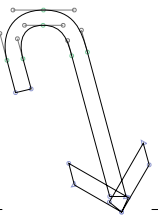
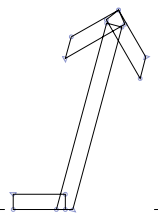
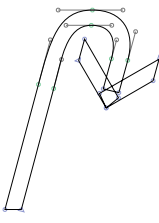
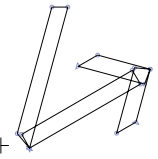
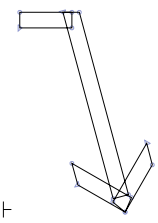

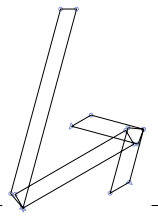
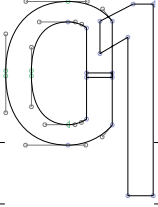
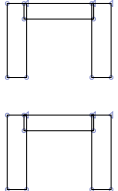
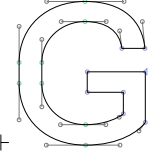



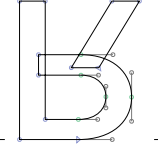

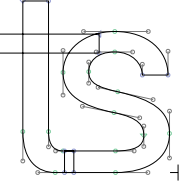
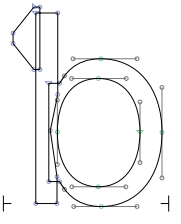

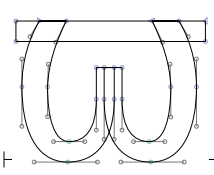
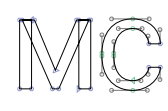
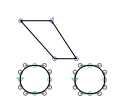
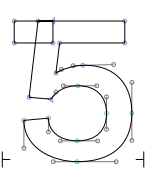
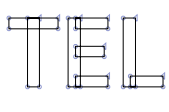

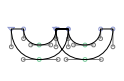
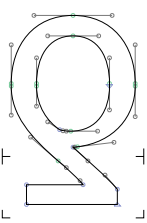
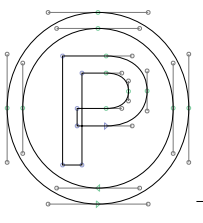
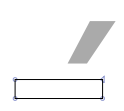

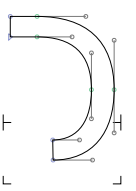

				
uni02FA 02FA	uni02FC 02FC	uni02FB 02FB	angstrom 212B	macrongravecomb.lc

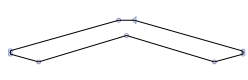
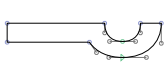
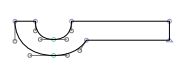
				
macronsubnosp 0331	ringlefthalfsubnosp 031C	Lsmallcap 029F	squaresubnosp 033B	Schwa 018F

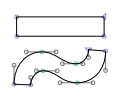
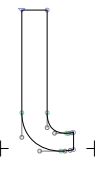
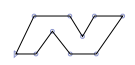
				
uni2B5B 2B5B	uni2B5C 2B5C	uni2B5A 2B5A	uni2B5F 2B5F	uni2B5D 2B5D

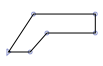
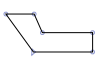
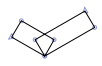
				
uni2B5E 2B5E	oi 01A3	finalmem 02AD	Gsmallcap 0262	Esh 01A9

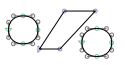
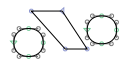
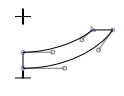
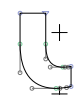
				
dieresismacroncomb.lc	Rsmallcapinv 0281	zerowidthjoiner FEFF	ts 02A6	tonesix 0185

				
uni1F16B 1F16B	pisybolgreek 03D6	uni1F16A 1F16A	dieresisgravecomb.lc	tonefive 01BD
				
tel 2121	commasuprevnosp 0314	hyphennobreak 2011	archdblsubnosp 032B	deltaturn 018D
				
published 2117	macronacutecomb.lc	onedotleader 2024	plus.dnomnosp 031F	largerighthook
				
romanthree 2162	uni1DCF 1DCF	uni1DCE 1DCE	uni1DCD 1DCD	uni1DCC 1DCC
				
uni1DCB 1DCB	uni1DCA 1DCA	tildemacroncomb.lc	iota1 0269	uni1DC9 1DC9
				
uni1DC8 1DC8	uni1DC7 1DC7	uni1DC5 1DC5	uni1DC3 1DC3	uni1DC2 1DC2
				
uni1DC1 1DC1	uni1DC0 1DC0	uniFE28 FE28	hooksubretronosp 0322	primerev1 2035



macrondieresiscomb.lc

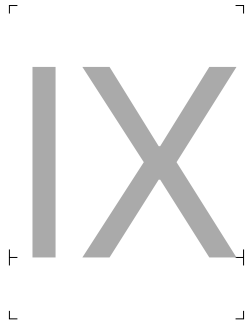

romannine 2168



uni1FBD 1FBD

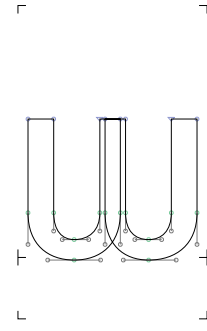

omegacyrillic 0461

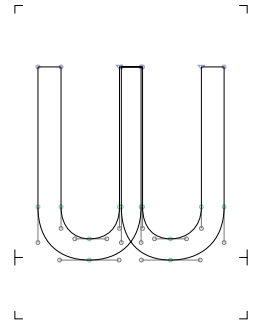

Omegacyrillic 0460

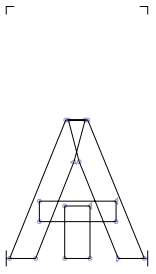

yuslitlecyrillic 0467

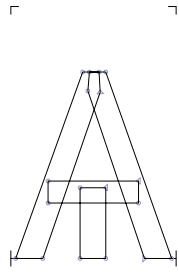

Yuslitlecyrillic 0466

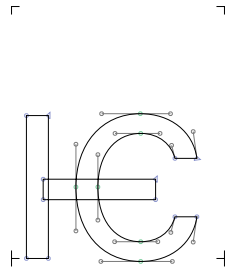

eiotifiedcyrillic 0465

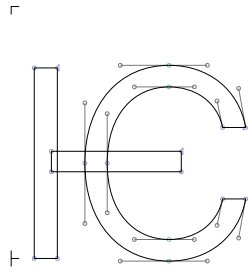

Eiotifiedcyrillic 0464

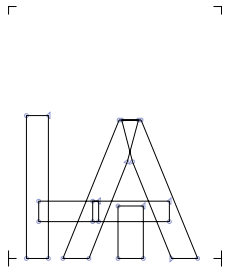

yuslitleiotifiedcyrillic 0469

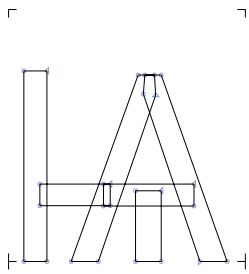

Yuslitleiotifiedcyrillic 0468

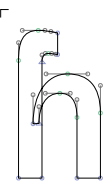

hhooksuper 02B1

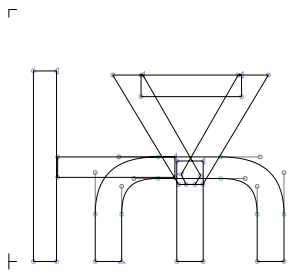

Yusbigiotifiedcyrillic 046C

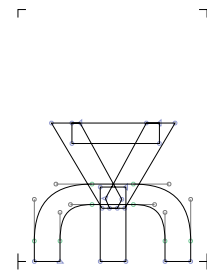

yusbigcyrillic 046B

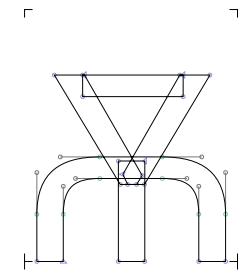

Yusbigcyrillic 046A

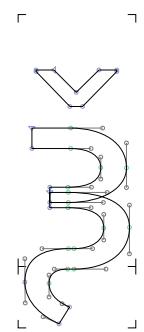

ksicyrillic 046F

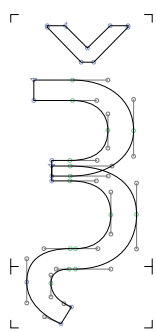

Ksicyrillic 046E

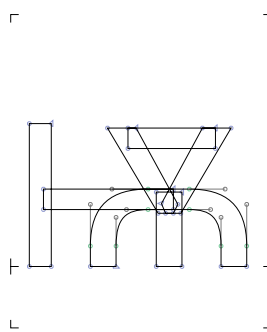

yusbigiotifiedcyrillic 046D



tildeacutecomb.lc



romanthousand 216F



macronsub 02CD



bullseye 0298



dieresiscaroncomb.lc

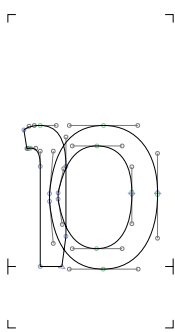

ascriptturn 0252

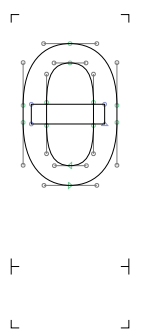

uni1D8F 1D8F



glottalstopbarrev 02A2



cyrillichook

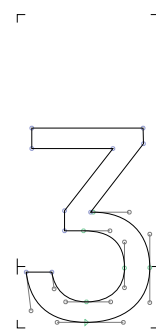

ezh 0292

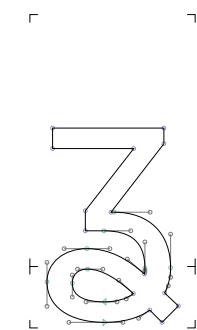

ezhcurl 0293

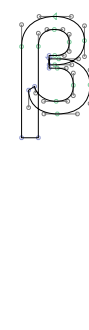

uni1DE9 1DE9



numeralgreek 0374

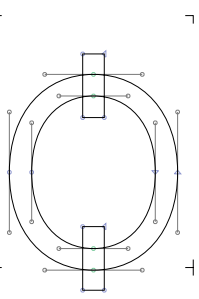

Omegaroundcyrillic 047A

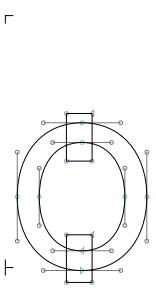

omegaroundcyrillic 047B

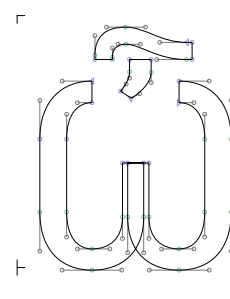

Omegatitlocyrillic 047C

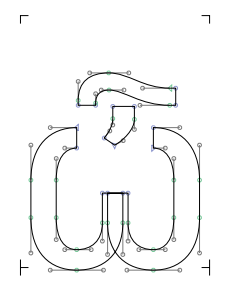

omegatitlocyrillic 047D



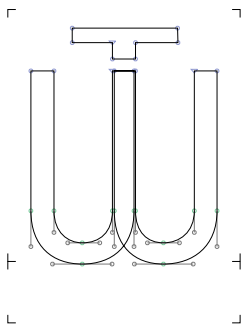

Otcyrillic 047E

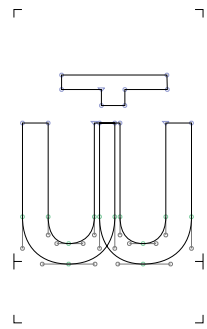

otcyrillic 047F



gcursive 0261

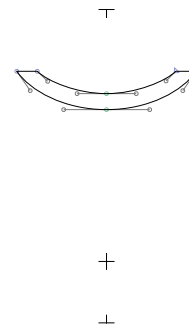

uni035D 035D

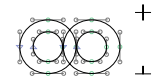

uni035A 035A



quotedbleversed 201F

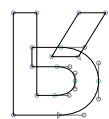

Rturnsuper 02B6



uni1FCE 1FCE



uni1FCF 1FCF

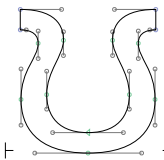

upsilonlatin 028A

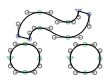

uni1FC1 1FC1



uni1FC0 1FC0



ringhalfleftcentered 02D3

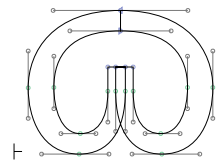

omegaclosed 0277



uni1DE2 1DE2

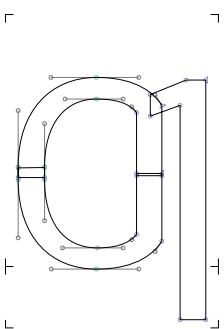

OI 01A2



xsupnosp 033D

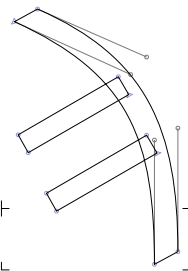

sampi 03E1

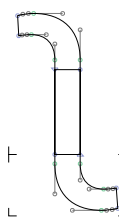

eshshortrev 0285

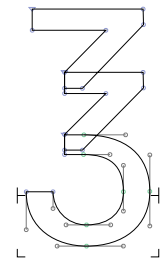

ounce 2125

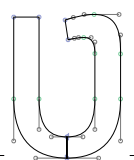

vscript 028B



acuterightnosp 0341



barmidlongnosp 0336



tildevertsupnosp 033E



linevertdbl nosp 030E



jhookdblbar 0284



overline 203E



ascript 0251

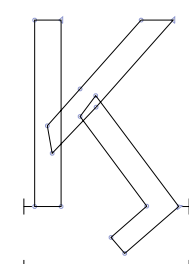

uni03CF 03CF



uni20DC 20DC



uni20DB 20DB



romansix 2165



uni1FBF 1FBF



uni1FBE 1FBE



ypogegrammeni 037A



romaneight 2167



charactertie 2040

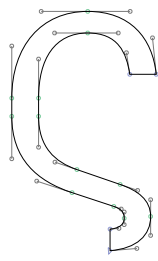

Stigma 03DA

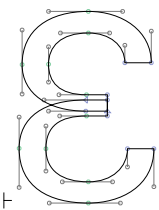

Epsilon1 0190



iotasubnosp 0345



pipedblbar 01C2

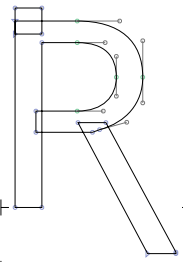

YR 01A6

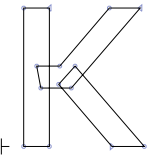

kgreenlandic 0138

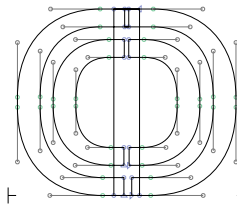

uni2182 2182

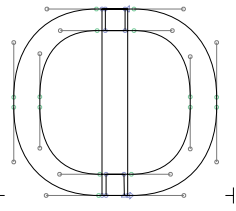

uni2180 2180

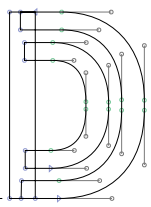

uni2181 2181

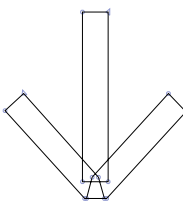

uni2186 2186

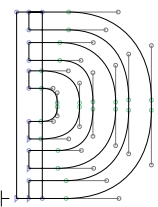

uni2187 2187

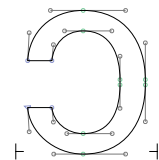

uni2184 2184

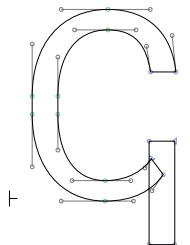

uni2185 2185

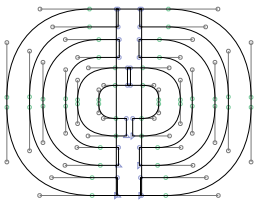

uni2188 2188

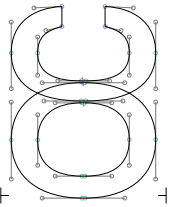

uni0222 0222



romanseven 2166



romanhundred 216D

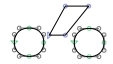

uni1FEE 1FEE

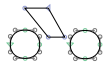

uni1FED 1FED



graveleftnosp 0340

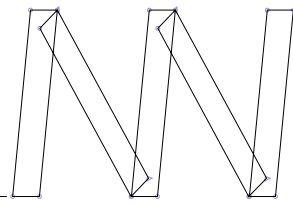

uniA7FF A7FF



tackleftnosp 0318

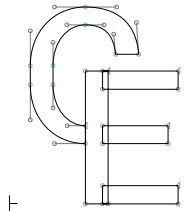

eurocurrency 20A0



uni20E8 20E8

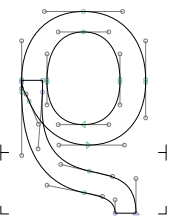

rho1 03F1

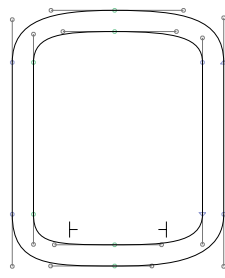

uni20E3 20E3



dblpostrophe 02EE

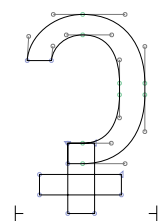

glottalstopbar 02A1



minus.dnomnosp 0320

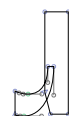

rturnsuper 02B4



linevert 02C8



primitriple rev1 2037



uni217F 217F

uni217E 217E	uni217D 217D	uni217C 217C	twelveroman 217B	elevenroman 217A
lambdabar 019B	pipe 01C0	tenroman 2179	nineroman 2178	eightroman 2177
sevenroman 2176	fiveroman 2174	fourroman 2173	threeroman 2172	tworoman 2171
oneroman 2170	underscoredblno sp 0333	tackrightsubno sp 0319	Sampi 03E0	schwa 0259
uni1DDA 1DDA	koppacyrillic 0481	Koppacyrillic 0480	titlocyrlliccmb 0483	thousandcyrillic 0482
dasiapneumatacyrilliccmb 0485	palatalizationcyrilliccmb 0484	uni0487 0487	psilipneumatacyrilliccmb 0486	uni0489 0489
uni0488 0488	uni20F0 20F0	eshcurl 0286	quotereversed 201B	romanfive 2164



uni1FDD

1FDD

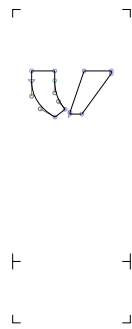

uni1FDE

1FDE



uni1DFD

1DFD



slashshortnosp

0337

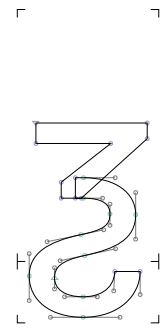

ezhtail

01BA

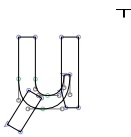

uni1DF0

1DF0



uni1DF1

1DF1

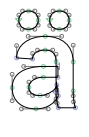

uni1DF2

1DF2

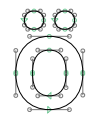

uni1DF3

1DF3

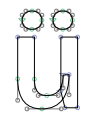

uni1DF4

1DF4



uni1DF5

1DF5



caronbelowcmb

032C



acutesubnosp

0317



romantwo

2161

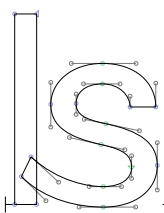

finalkaf

02AA



uni1DFE

1DFE

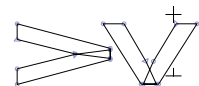

uni1DFF

1DFF



uni1FEF

1FEF

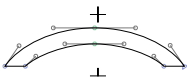

uni1DFC

1DFC

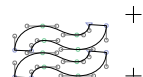

uni1DFD

1DFD



dblprimemod

02BA

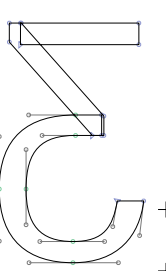

Ezhreversed

01B8

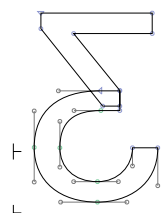

ezhreversed

01B9

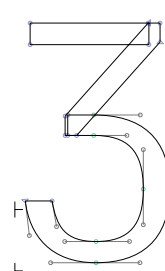

Ezh

01B7



romanfifty

216C



ringhalfright

02BE

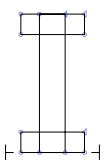

Ismallcap

026A



uptackmod

02D4



hyphendot

2027



uniFE29

FE29



uniFE20

FE20



uniFE21

FE21



uniFE22

FE22



uniFE23

FE23



uniFE24

FE24

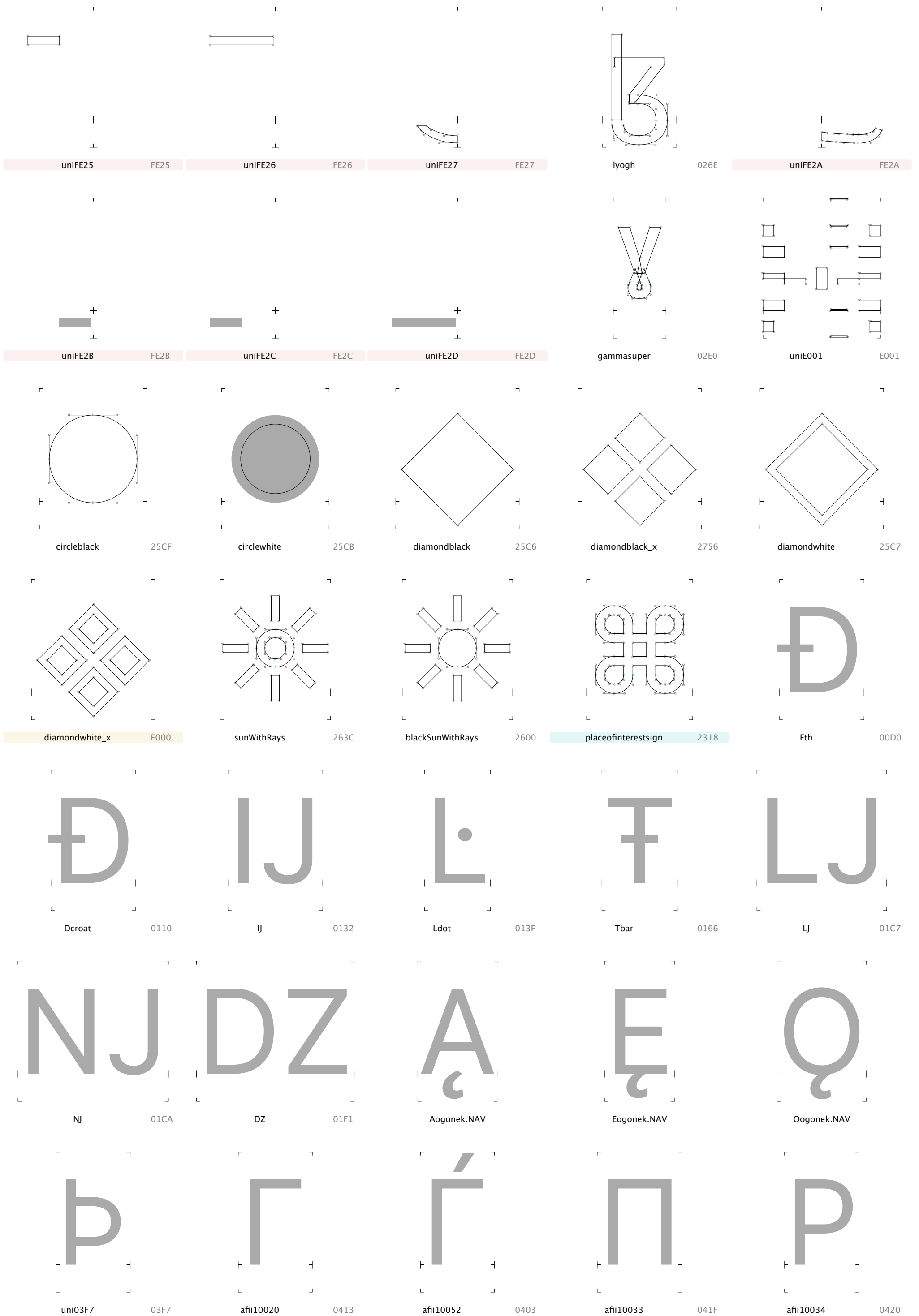

afii10035 0421

afii10036 0422

afii10039 0425

afii10146 0462

Psicyrillic 0470

Ukcyrillic 0478

uni048C 048C

Ghestrokecyrillic 0492

Zedescendercyrillic 0498

Esdescendercyrillic 04AA

Tedescendercyrillic 04AC

Ustraightcyrillic 04AE

Ustraightstrokecyrillic 04B0

Chedescenderabkhasiancyrillic 04BE

palochkacyrillic 04C0

Chekhakassiancyrillic 04CB

uni04F6 04F6

uni04FE 04FE

afii10061 040C

Schwadiesiscyrlilic 04DA

Zhebrevecyrlilic 04C1

Zhedierescyrlilic 04DC

Zedierescyrlilic 04DE

afii10062 040E

Umacroncyrlilic 04EE

Udierescyrlilic 04F0

Uhungarumlautcyrlilic 04F2

Chedierescyrlilic 04F4

Yerudierescyrlilic 04F8

uni04EC 04EC

Izhitsadblgravecyrlilic 0476

uni0299 0299

uni029C 029C

aogonek.NAV

eogonek.NAV

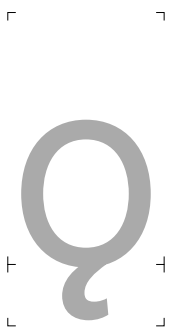

oogonek.NAV

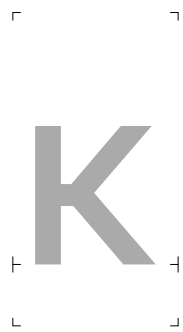

kappa 03BA



mugreek 03BC

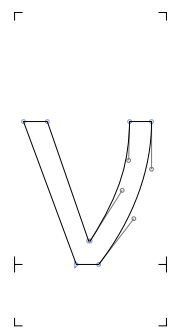

nu 03BD



uni03F8 03F8



uni1F71 1F71



uni1F73 1F73



uni1F75 1F75



uni1F77 1F77

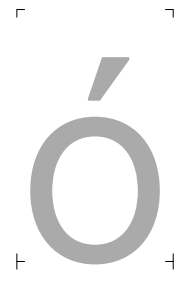

uni1F79 1F79

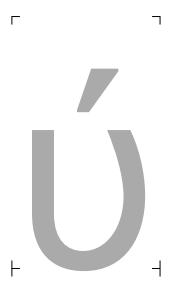

uni1F7B 1F7B

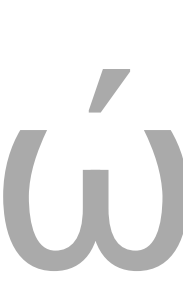

uni1F7D 1F7D

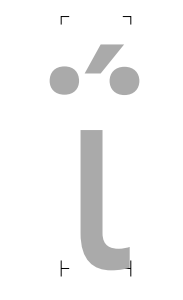

uni1FD3 1FD3



uni1FE3 1FE3



psicyrillic 0471



ghestrokecyrillic 0493



zedescendercyrillic 0499



esdescendercyrillic 04AB



tedescendercyrillic 04AD



ustraightcyrillic 04AF



ustraightstrokecyrillic 04B1



chedescenderabkhasiancyrillic 04BF



chekhakassiancyrillic 04CC



schwacyrillic 04D9



schwadiesiscyrlilic 04DB



obarredcyrillic 04E9



obarreddieresiscyrlilic 04EB



uni04F7 04F7



uni04FF 04FF



chedieresiscyrlilic 04F5



uni04ED 04ED



gjecyrlilic 0453



iishortcyrlilic 0439



uni045D 045D



imacroncyrlilic 04E3



idièresiscyrillic 04E5



izhitsadblgravecyrillic 0477



kjecyrillic 045C



yerudiesiscyrillic 04F9



zedièresiscyrillic 04DF



zhebrevecyrillic 04C2

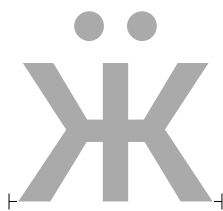

zhedièresiscyrillic 04DD



Ezhcaron 01EE

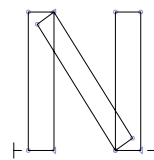

Nsmallcap 0274

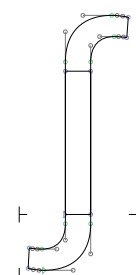

esh 0283

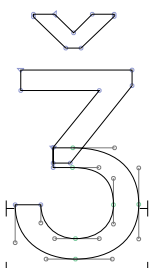

ezhcaron 01EF



pipedbl 01C1

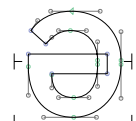

uni2094 2094



uni02B2.ccmp

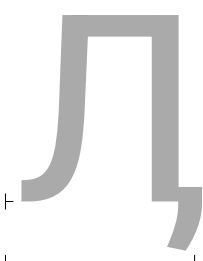

Eltail-cy 04C5

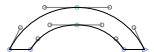

uniA92E A92E



tonebarextrahighmod.cn 02E5

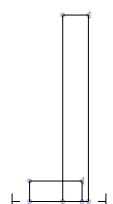

tonebarextralowmod.cn 02E9

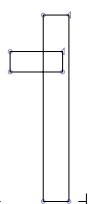

tonebarhighmod.cn 02E6

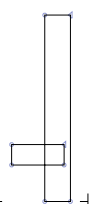

tonebarlowmod.cn 02E8

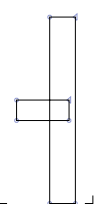

tonebarmidmod.cn 02E7



commaabovecmb 0313



commaaboverightcmb 0315



hooksubpalatnosp 0321



bridgeinvsubnosp 033A

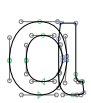

uni1DE7 1DE7

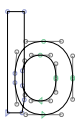

uni1DE8 1DE8



uni1DEA 1DEA

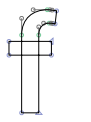

uni1DEB 1DEB

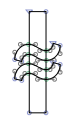

uni1DEC 1DEC

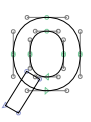

uni1DED 1DED



uni1DEE 1DEE

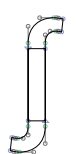

uni1DEF 1DEF



macronacutecomb.cn



macrongravecomb.cn



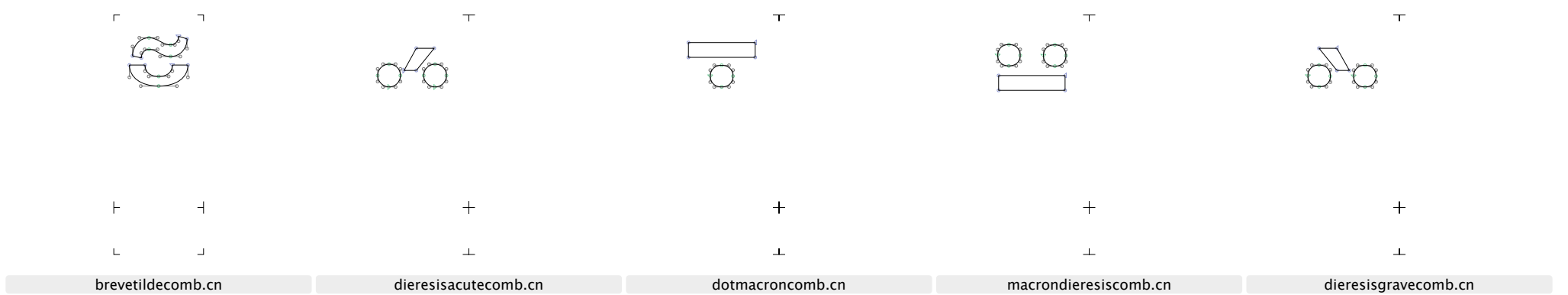
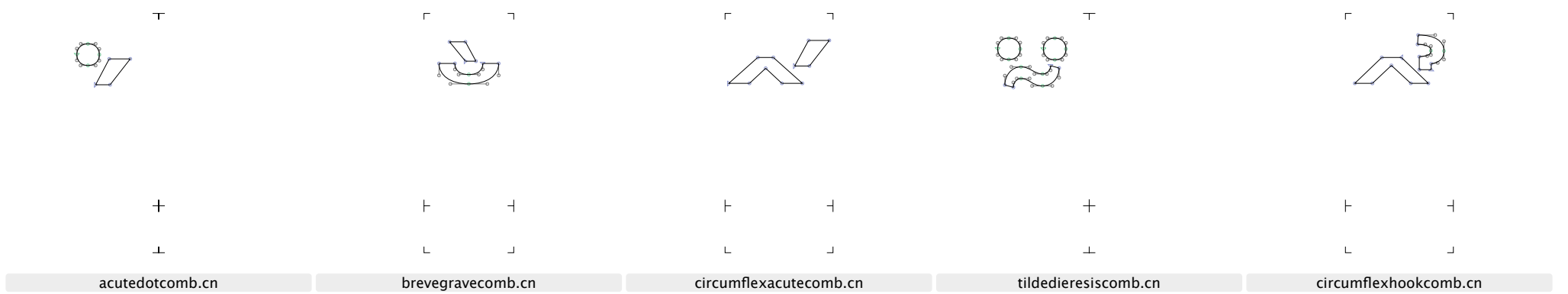
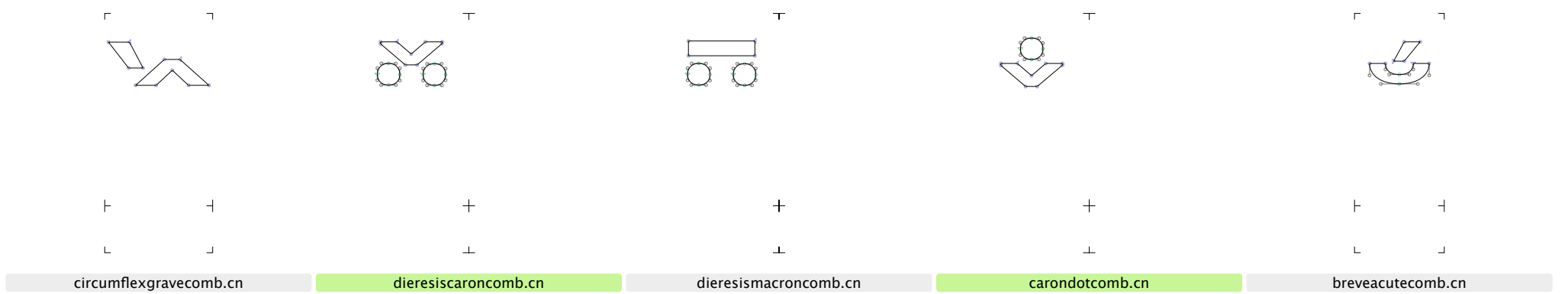
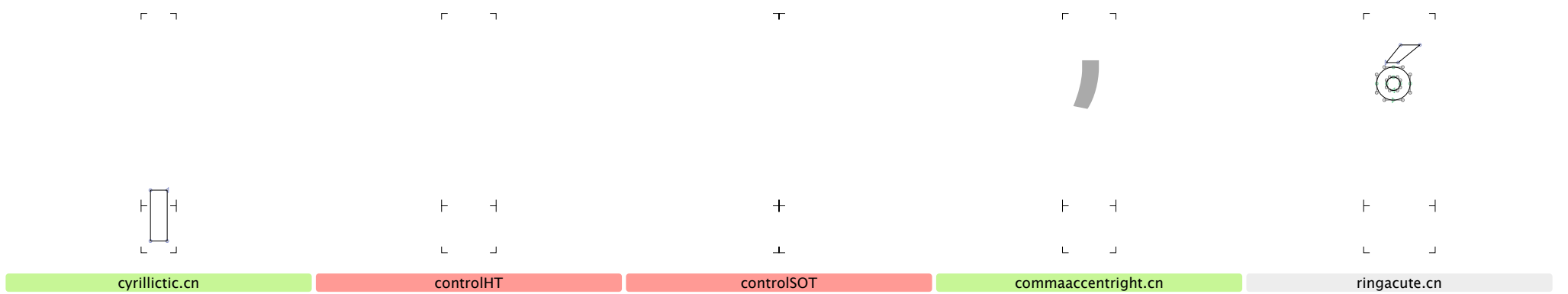
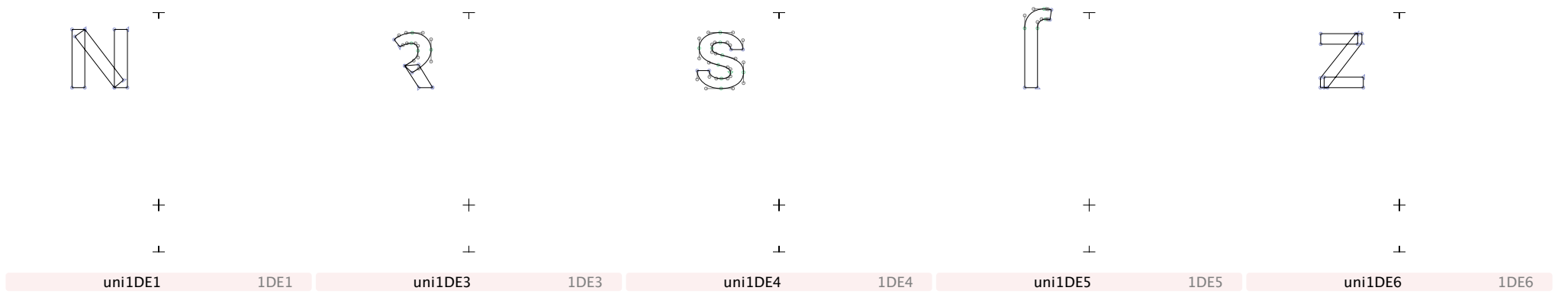
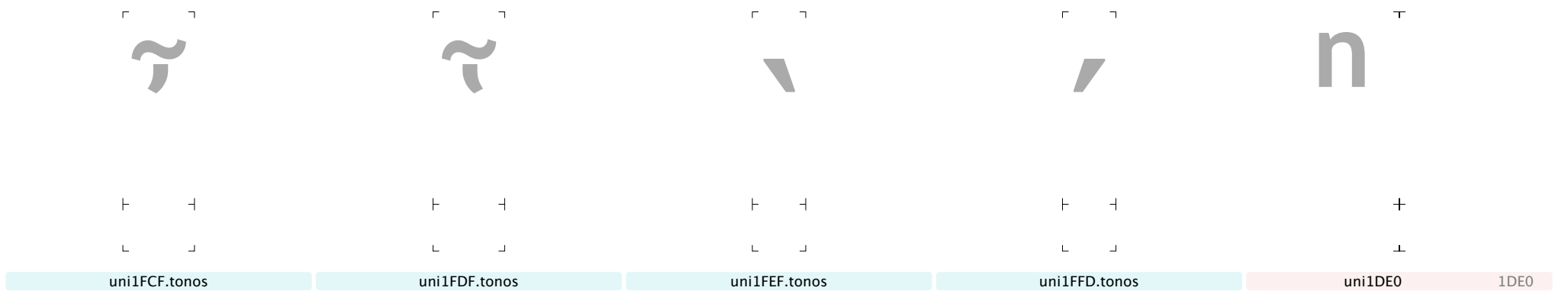
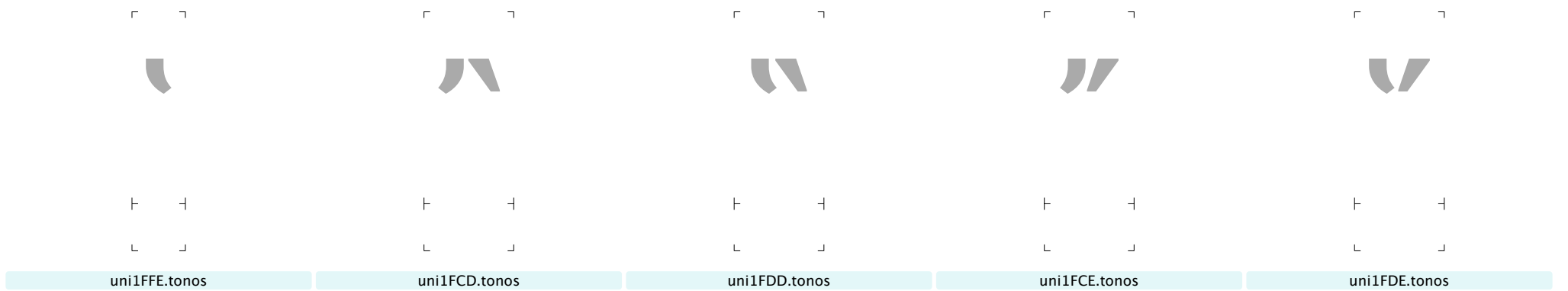

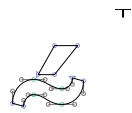
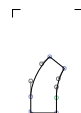
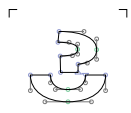
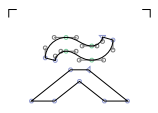
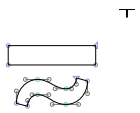

tildemacroncomb.cn

circumflextildecomb.cn

brevehookcomb.cn

commaaccentrotate.cn

tildeacutecomb.cn

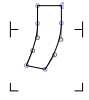

tonostop

cyrillictail.cn

koronisaccentleft.cn